

# Operating Manual

Translation of the original operating manual

## BF / BF-UL – Incubators with forced convection with microprocessor temperature controller

Model	Model version	Art. No.
BF 400	BF400-230V	9010-0241, 9110-0241
BF 400-UL	BF400UL-120V	9010-0242, 9110-0242

### **BINDER GmbH**

- ▶ Address: Post office box 102, 78502 Tuttlingen, Germany ▶ Phone: +49 7462 2005 0
- ▶ Fax: +49 7462 2005 100 ▶ Internet: <http://www.binder-world.com>
- ▶ E-mail: [info@binder-world.com](mailto:info@binder-world.com) ▶ Service Hotline: +49 7462 2005 555
- ▶ Service Fax: +49 7462 2005 93 555 ▶ Service E-Mail: [customerservice@binder-world.com](mailto:customerservice@binder-world.com)
- ▶ Service Hotline USA: +1 866 885 9794 or +1 631 224 4340 x3
- ▶ Service Hotline Asia Pacific: +852 390 705 04 or +852 390 705 03
- ▶ Service Hotline Russia and CIS: +7 495 988 15 16

## Content

<b>1. SAFETY</b>	<b>4</b>
1.1 Personnel Qualification	4
1.2 Operating manual	4
1.3 Legal considerations	4
1.3.1 Intellectual property	5
1.4 Structure of the safety instructions	5
1.4.1 Signal word panel	5
1.4.2 Safety alert symbol	6
1.4.3 Pictograms	6
1.4.4 Word message panel structure	7
1.5 Localization / position of safety labels on the chamber	7
1.6 Type plate	8
1.7 UKCA Label	9
1.8 General safety instructions on installing and operating the chambers	9
1.9 Intended use	11
1.10 Foreseeable Misuse	12
1.11 Residual Risks	13
1.12 Operating instructions	14
1.13 Measures to prevent accidents	14
<b>2. CHAMBER DESCRIPTION</b>	<b>15</b>
2.1 Chamber overview	16
<b>3. COMPLETENESS OF DELIVERY, TRANSPORTATION, STORAGE, AND INSTALLATION</b>	<b>16</b>
3.1 Unpacking, and checking equipment and completeness of delivery	16
3.2 Guidelines for safe lifting and transportation	17
3.3 Storage	17
3.4 Location of installation and ambient conditions	17
<b>4. INSTALLATION OF THE EQUIPMENT</b>	<b>18</b>
4.1 Electrical connection	18
4.2 Connection to a suction plant (optional)	19
<b>5. START UP</b>	<b>20</b>
5.1 Turning on the chamber	20
5.2 Heating operation display	20
5.3 Air change	20
<b>6. CONTROLLER SETTING</b>	<b>21</b>
6.1 Display / entry of temperature and ventilation set-points (without ramp function)	21
6.2 Display / entry of temperature and ventilation set-points (with selected temperature ramp)	22
6.3 Time functions: Continuous operation and Timer operation	23
6.3.1 Switching between Continuous operation and Timer operation	24
6.3.2 Continuous operation	24
6.3.3 Setting the timer values	25
6.4 User level settings	26
6.4.1 Temperature unit change between degrees Celsius °C and degrees Fahrenheit °F	27
6.4.2 Entering a temperature ramp	27
6.4.3 Chamber addressing	28
6.4.4 Selecting the timer function	29
6.4.5 Setting the interface mode and, if appropriate, the printer interval	30
6.5 Temperature programming example	31
6.6 General notes	31

<b>7.</b>	<b>TEMPERATURE SAFETY DEVICE CLASS 3.1 (DIN 12880)</b> .....	<b>32</b>
<b>8.</b>	<b>OPTIONS</b> .....	<b>33</b>
8.1	Disconnectable audible over-temperature alarm (option).....	33
8.2	APT-COM™ 4 Multi Management Software (option).....	33
8.3	Analog output for temperature (option).....	33
8.4	Additional Pt100 temperature sensor (option).....	34
<b>9.</b>	<b>CLEANING AND DECONTAMINATION</b> .....	<b>34</b>
9.1	Cleaning.....	35
9.2	Decontamination / chemical disinfection.....	36
<b>10.</b>	<b>MAINTENANCE AND SERVICE, TROUBLESHOOTING, REPAIR, TESTING...</b>	<b>37</b>
10.1	General information, personnel qualification.....	37
10.2	Maintenance intervals, service.....	38
10.3	Simple troubleshooting.....	38
10.4	Sending the chamber back to BINDER GmbH.....	40
<b>11.</b>	<b>DISPOSAL</b> .....	<b>40</b>
11.1	Disposal of the transport packing.....	40
11.2	Decommissioning.....	41
11.3	Disposal of the chamber in the Federal Republic of Germany.....	41
11.4	Disposal of the chamber in the member states of the EU except for the Federal Republic of Germany.....	42
11.5	Disposal of the chamber in non-member states of the EU.....	43
<b>12.</b>	<b>TECHNICAL DESCRIPTION</b> .....	<b>43</b>
12.1	Factory calibration and adjustment.....	43
12.2	Definition of usable volume.....	44
12.3	Over current protection.....	44
12.4	Technical data, BF / BF-UL 400.....	44
12.5	Equipment and options (extract).....	46
12.6	Accessories and spare parts (extract).....	47
<b>13.</b>	<b>CERTIFICATES AND DECLARATIONS OF CONFORMITY</b> .....	<b>48</b>
13.1	EU Declaration of Conformity.....	48
13.2	UKCA Declaration of Conformity.....	50
13.3	Certificate for the GS mark of conformity of the “Deutsche Gesetzliche Unfallversicherung e.V.” (German Social Accident Insurance) DGUV.....	51
<b>14.</b>	<b>CONTAMINATION CLEARANCE CERTIFICATE</b> .....	<b>53</b>
14.1	For chambers located outside the USA and Canada.....	53
14.2	For chambers located in the USA and Canada.....	56

**Dear customer,**

For the correct operation of the chambers, it is important that you read this operating manual completely and carefully and observe all instructions as indicated. Failure to read, understand and follow the instructions may result in personal injury. It can also lead to damage to the chamber and/or poor equipment performance.

## 1. Safety

### 1.1 Personnel Qualification



The chamber must only be installed, tested, and started up by personnel qualified for assembly, startup, and operation of the chamber. Qualified personnel are persons whose professional education, knowledge, experience and knowledge of relevant standards allow them to assess, carry out, and identify any potential hazards in the work assigned to them. They must have been trained and instructed, and be authorized, to work on the chamber.

The chamber should only be operated by laboratory personnel especially trained for this purpose and familiar with all precautionary measures required for working in a laboratory. Observe the national regulations on minimum age of laboratory personnel.

### 1.2 Operating manual

This operating manual is part of the components of delivery. Always keep it handy for reference in the vicinity of the chamber. If selling the unit, hand over the operating manual to the purchaser.

To avoid injuries and damage observe the safety instructions of the operating manual. Failure to follow instructions and safety precautions can lead to significant risks.

	<div style="background-color: red; color: white; padding: 5px; text-align: center;">  <b>DANGER</b> </div> <p><b>Dangers due to failure to observe the instructions and safety precautions.</b></p> <p><b>Serious injuries and chamber damage. Risk of death.</b></p> <ul style="list-style-type: none"> <li>➤ Observe the safety instructions in this Operating Manual.</li> <li>➤ Follow the operating procedures in this Operating Manual.</li> <li>➤ Carefully read the complete operating instructions of the chamber prior to installing and using the chamber.</li> <li>➤ Keep the operating manual for future reference</li> </ul>
---	---

	<p>Make sure that all persons who use the chamber and its associated work equipment have read and understood the Operating Manual.</p>
---	--

This Operating Manual is supplemented and updated as needed. Always use the most recent version of the Operating Manual. When in doubt, call the BINDER Service Hotline for information on the up-to-dateness and validity of this Operating Manual.

### 1.3 Legal considerations

This operating manual is for informational purposes only. It contains information for correct and safe installing, start-up, operation, decommissioning, cleaning and maintenance of the product. Note: the contents and the product described are subject to change without notice.

Understanding and observing the instructions in this operating manual are prerequisites for hazard-free use and safety during operation and maintenance. Images are to provide basic understanding. They may deviate from the actual version of the chamber. The actual scope of delivery can, due to optional or special design, or due to recent technical changes, deviate from the information and illustrations in these instructions this operating manual. In no event shall BINDER be held liable for any damages, direct or incidental arising out of or related to the use of this manual.

This operating manual cannot cover all conceivable applications. If you would like additional information, or if special problems arise that are not sufficiently addressed in this manual, please ask your dealer or contact us directly, e.g. by phone at the number located on page one of this manual

Furthermore, we emphasize that the contents of this operating manual are not part of an earlier or existing agreement, description, or legal relationship, nor do they modify such a relationship. All obligations on the part of BINDER derive from the respective purchase contract, which also contains the entire and exclusively valid statement of warranty administration and the general terms and conditions, as well as the legal regulations valid at the time the contract is concluded. The statements in this manual neither augment nor restrict the contractual warranty provisions.

### 1.3.1 Intellectual property

**This operating manual is protected by copyright. Any unauthorized copying or disclosure to third parties is strictly prohibited. We reserve the right to take legal action and, if necessary, to assert claims for damages in the event of infringement.**

**Trademark Information:** All BINDER trademarks relating to products or service, as well as trade names, logos and product names used on the website, products and documents of BINDER company are trademarks or registered trademarks of BINDER company (including BINDER GmbH, BINDER Inc.) in the U.S. and other countries and communities of states. This includes word marks, position marks, word/figurative marks, design configurations, figurative marks, and design patents.

**Patent Information:** BINDER products, categories of products, and accessories may be covered by one or more patents and/or utility models in the U.S. and other countries and communities of states. This information is provided to satisfy the virtual patent marking provisions of various jurisdictions, in particular it is intended to serve as notice under 35 U.S.C. § 287(a). Products and services listed on the BINDER website may be sold individually or as part of a combination product. Additional patent applications may also be pending in the U.S. and other countries and communities of states.

Please visit [www.binder-world.com](http://www.binder-world.com) for more information.

## 1.4 Structure of the safety instructions

In this operating manual, the following safety definitions and symbols indicate dangerous situations following the harmonization of ISO 3864-2 and ANSI Z535.6.

### 1.4.1 Signal word panel

Depending on the probability of serious consequences, potential dangers are identified with a signal word, the corresponding safety color, and if appropriate, the safety alert symbol.

 <b>DANGER</b>
Indicates an imminently hazardous situation that, if not avoided, will result in death or serious (irreversible) injury.

 <b>WARNING</b>
Indicates a potentially hazardous situation which, if not avoided, could result in death or serious (irreversible) injury

**CAUTION**

Indicates a potentially hazardous situation which, if not avoided, may result in moderate or minor (reversible) injury

**NOTICE**

Indicates a potentially hazardous situation which, if not avoided, may result in damage to the product and/or its functions or of a property in its proximity.

### 1.4.2 Safety alert symbol





Use of the safety alert symbol indicates a **risk of injury**.

Observe all measures that are marked with the safety alert symbol in order to avoid death or injury.

### 1.4.3 Pictograms

Warning signs			
Electrical hazard	Hot surface	Explosive atmosphere	Stability hazard
Lifting hazard	Risk of corrosion and / or chemical burns	Harmful substances	Biohazard
Pollution Hazard			
Mandatory action signs			
Mandatory regulation	Read operating instructions	Disconnect the power plug	Lift with several persons
Lift with mechanical assistance	Environment protection	Wear protective gloves	Wear safety goggles

Prohibition signs			
 Do NOT touch	 Do NOT spray with water		

	<b>Information</b> to be observed in order to ensure optimum function of the product.
---	---



#### 1.4.4 Word message panel structure

<p><b>Type / cause of hazard.</b></p> <p><b>Possible consequences.</b></p> <p>∅ Instruction how to avoid the hazard: prohibition</p> <p>➤ Instruction how to avoid the hazard: mandatory action</p>
---

Observe all other notes and information not necessarily emphasized in the same way, in order to avoid disruptions that could result in direct or indirect injury or property damage.

#### 1.5 Localization / position of safety labels on the chamber

The following labels are located on the chamber:

Pictograms (Warning signs)	Service label
 <p>Hot surface</p> <ul style="list-style-type: none"> <li>• Inner glass door next to the glass door handle</li> <li>• On chamber rear next to the exhaust duct</li> </ul>	
 <p>Read operating manual</p> <ul style="list-style-type: none"> <li>• UL chambers: outer chamber door</li> <li>• With optional interior socket: below the interior socket</li> </ul>	

	<b>Keep safety labels complete and legible.</b>
---	---

Replace safety labels that are no longer legible. Contact BINDER Service for these replacements.

## 1.6 Type plate

The type plate is located on the chamber front behind the door, bottom left-hand.











Nominal temp.	100 °C 212 °F	0,85 kW / 3,7 A 230 V / 50 Hz	  
IP protection	20	230 V / 60 Hz	
Safety device	DIN 12880	1 N ~	 
Class	3.1		
Art. No.	9010-0241		
Project No.			
Built	2022	Incubator	
			
BINDER GmbH Im Mittleren Ösch 5 78532 Tuttlingen / Germany www.binder-world.com			
		<b>BF 400</b>	 <b>Serial No. 0000000000000</b> Made in Germany
		<b>E1</b>	

Figure 1: Type plate (example: BF 400 regular chamber)

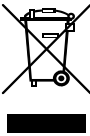

### Indications of the type plate (example)

Indication		Information
BINDER		Manufacturer: BINDER GmbH
BF 115		Model designation
Incubator		Device name
Serial No.	000000000000	Serial no. of the chamber
Built	2022	Year of construction
Nominal temperature	100 °C 212 °F	Nominal temperature
IP protection	20	IP type of protection acc. to EN 60529
Temp. safety device	DIN 12880	Temperature safety device acc. to standard DIN 12880
Class	3.1	Class of temperature safety device
Art. No.	9010-0241	Art. no. of the chamber
Project No.	---	Optional: Special application acc. to project no.
0,85 kW		Nominal power
3,7 A		Nominal current
230 V / 50 Hz		Nominal voltage +/- 10% at the indicated power frequency
230 V / 60 Hz		
1 N ~		Current type

### Symbols on the type plate

Symbol	Valid for	Information
	All chambers	CE conformity marking
	All chambers	Electrical and electronic equipment manufactured / placed on the market in the EU after 13 August 2005 and be disposed of in separate collection according to Directive 2012/19/EU on waste electrical and electronic equipment (WEEE).
	Not for UL chambers	GS mark of conformity of the "Deutsche Gesetzliche Unfallversicherung e.V. (DGUV), Prüf- und Zertifizierungsstelle Nahrungsmittel und Verpackung im DGUV Test" (German Social Accident Insurance (DGUV), Testing and Certification Body for Foodstuffs and Packaging Industry in DGUV Test).



Symbol	Valid for	Information
	Not for UL chambers	The chamber is certified according to Customs Union Technical Regulation (CU TR) for the Eurasian Economic Union (Russia, Belarus, Armenia, Kazakhstan Kyrgyzstan).
	UL chambers only	The chamber is certified by Underwriters Laboratories Inc.® according to the following standards: <ul style="list-style-type: none"> <li>• UL 61010A-1, 1<sup>st</sup> Edition, UL 61010A-2-10, 1<sup>st</sup> Edition</li> <li>• CSA C22.2 No. 1010.1-92, IEC 1010-2-10</li> </ul>

## 1.7 UKCA Label

The sticker with UKCA Authorised Representative details sticks next to the type plate.



Figure 2: UKCA Label

### Symbol on the sticker

Symbol	Applies to	Information
	All models except UL models	UKCA conformity marking

## 1.8 General safety instructions on installing and operating the chambers



With regard to operating the chambers and to the installation location, please observe the local and national regulations relevant for your country (for Germany: DGUV guidelines 213-850 on safe working in laboratories, issued by the employers' liability insurance association).

BINDER GmbH is only responsible for the safety features of the chamber provided skilled electricians or qualified personnel authorized by BINDER perform all maintenance and repair, and if components relating to chamber safety are replaced in the event of failure with original spare parts.



To operate the chamber, use only original BINDER accessories or accessories from third-party suppliers authorized by BINDER. The user is responsible for any risk caused by using unauthorized accessories.

<b>NOTICE</b>	
	<p><b>Danger of overheating due to lack of ventilation.</b></p> <p><b>Damage to the chamber.</b></p> <ul style="list-style-type: none"> <li>⊘ Do NOT install the chamber in unventilated recesses.</li> <li>➤ Ensure sufficient ventilation for dispersal of the heat.</li> <li>➤ Observe the prescribed minimum distances when installing the chamber (chap. 3.4)</li> </ul>

Do not install or operate the chamber in hazardous locations.



	 <b>DANGER</b>
	<p><b>Danger of explosion due to combustible dusts or explosive mixtures in the vicinity of the chamber.</b></p> <p><b>Serious injury or death from burns and / or explosion pressure.</b></p> <ul style="list-style-type: none"> <li>⊘ Do NOT operate the chamber in potentially explosive areas.</li> <li>➤ KEEP combustible dust or air-solvent mixtures AWAY from the chamber.</li> </ul>

The chamber does not dispose of any measures of explosion protection.

	 <b>DANGER</b>
	<p><b>Danger of explosion due to introduction of flammable or explosive substances in the chamber.</b></p> <p><b>Serious injury or death from burns and / or explosion pressure.</b></p> <ul style="list-style-type: none"> <li>⊘ Do NOT introduce any substance into the chamber which is combustible or explosive at working temperature.</li> <li>⊘ Do NOT introduce any combustible dust or air-solvent mixture in the inner chamber.</li> </ul>



Any solvent contained in the charging material must not be explosive or inflammable. I.e., irrespective of the solvent concentration in the steam room, NO explosive mixture with air must form. The temperature inside the chamber must lie below the flash point or below the sublimation point of the charging material. Familiarize yourself with the physical and chemical properties of the charging material, as well as the contained moisture constituent and its behavior with the addition of heat energy.

Familiarize yourself with any potential health risks caused by the charging material, the contained moisture constituent or by reaction products that may arise during the temperature process. Take adequate measures to exclude such risks prior to putting the chamber into operation.

	 <b>DANGER</b>
	<p><b>Electrical hazard by water entering the chamber.</b></p> <p><b>Deadly electric shock.</b></p> <ul style="list-style-type: none"> <li>⊘ The chamber must NOT become wet during operation, cleaning, or maintenance.</li> <li>⊘ Do NOT install the chamber in damp areas or in puddles.</li> <li>➤ Set up the chamber in a way that it is splash-proof.</li> </ul>

The chambers were produced in accordance with VDE regulations and were routinely tested in accordance to VDE 0411-1 (IEC 61010-1).

During and shortly after operation, the temperature of the inner surfaces almost equals the set-point. The glass doors, the glass door handles, the inner chamber, the exhaust duct, and the door gaskets will become hot during operation.

	 <b>CAUTION</b>
	<p><b>Danger of burning by touching hot chamber parts during operation.</b></p> <p><b>Burns.</b></p> <ul style="list-style-type: none"> <li>⊘ Do NOT touch the glass doors, the inner surfaces, the exhaust duct, the door gaskets or the charging material during operation.</li> </ul>

## 1.9 Intended use



Observing the instructions in this operating manual and conducting regular maintenance work (chap. 9) is part of the intended use.

**Any use of the chambers that does not comply with the requirements specified in this Operating Manual shall be considered improper use.**

**Other applications than those described in this chapter are not approved.**

### Use

BINDER incubators with forced convection BF / BF-UL are suitable for exact tempering of harmless materials and for drying and heat treatment of solid or pulverized charging material, as well as bulk material, using the supply of heat. Because of their precise temperature accuracy the chambers are especially useful for incubation of cultures at a standard temperature of 37 °C / 98.6 °F and for warm storage of liquids in containers.



Do NOT use the chambers for drying processes when large quantities of vapor would form and result in condensation.

### Requirements for the chamber load



A solvent content must not be explosive or flammable. A mixture of any component of the charging material with air must NOT be explosive. The operating temperature must lie below the flash point or below the sublimation point of the charging material. Any component of the charging material must NOT be able to release toxic gases.

The loading material shall not contain any corrosive ingredients that may damage the machine components. Such ingredients include in particular acids and halides. Any corrosive damage caused by such ingredients is excluded from liability by BINDER GmbH.

The chamber does not dispose of any measures of explosion protection.

 	 <b>DANGER</b>
	<p><b>Explosion or implosion hazard and danger of poisoning through the introduction of unsuitable loading material.</b></p> <p><b>Poisoning. Serious injury or death from burns and / or explosion pressure.</b></p> <ul style="list-style-type: none"> <li>⊘ Do NOT introduce any substance combustible or explosive at working temperature into the chamber, in particular no energy sources such as batteries or lithium-ion batteries.</li> <li>⊘ NO explosive dust or air-solvent mixture in the inner chamber.</li> <li>⊘ Do NOT introduce any substance which could lead to release of toxic gases.</li> </ul>

Contamination of the chamber by toxic, infectious or radioactive substances must be prevented

 	 <b>WARNING</b>
	<p><b>Danger of intoxication and infection through contamination of the chamber with toxic, infectious or radioactive substances.</b></p> <p><b>Damages to health.</b></p> <ul style="list-style-type: none"> <li>➤ Protect the interior of the chamber from contamination by toxic, infectious or radioactive substances.</li> <li>➤ Take suitable protective measures when introducing and removing toxic, infectious or radioactive material</li> </ul>

In case of foreseeable use of the chamber there is no risk for the user through the integration of the chamber into systems or by special environmental or operating conditions in the sense of EN 61010-1:2010. For this, the intended use of the chamber and all its connections must be observed.

## Medical devices

The chambers are not classified as medical devices as defined by Regulation (EU) No 2017/745.



Due to the special demands of the Medical Products legislation, these chambers are not qualified to perform sterilization of medical devices as defined by Regulation (EU) No 2017/745.

## Personnel Requirements

Only trained personnel with knowledge of the Operating Manual can set up and install the chamber, start it up, operate, clean, and take it out of operation. Service and repairs call for further technical requirements (e.g. electrical know-how), as well as knowledge of the service manual.

## Installation site requirements

The chambers are designed for setting up inside a building (indoor use).

The requirements described in the Operating Manual for installation site and ambient conditions (chap. 3.4) must be met.



**WARNING:** If customer should use a BINDER chamber running in non-supervised continuous operation, we strongly recommend in case of inclusion of irrecoverable specimen or samples to split such specimen or samples and store them in at least two chambers, if this is feasible.

## 1.10 Foreseeable Misuse

Other applications than those described in chap. 1.8 are not approved.

This expressly includes the following misuses (the list is not exhaustive), which pose risks despite the inherently safe construction and existing technical safety equipment:

- Non-observance of Operating Manual
- Non-observance of information and warnings on the chamber (e.g. control unit messages, safety identifiers, warning signals)
- Installation, startup, operation, maintenance and repair by untrained, insufficiently qualified, or unauthorized personnel
- Missed or delayed maintenance and testing
- Non-observance of traces of wear and tear
- Insertion of materials excluded or not permitted by this Operating Manual.
- Non-compliance with the admissible parameters for processing the respective material.
- Installation, testing, service or repair in the presence of solvents
- Installation of replacement parts and use of accessories and operating resources not specified and authorized by the manufacturer
- Installation, startup, operation, maintenance or repair of the chamber in absence of operating instructions
- Bypassing or changing protective systems, operation of the chamber without the designated protective systems
- Non-observance of messages regarding cleaning and disinfection of the chamber.
- Spilling water or cleaning agent on the chamber, water penetrating into the chamber during operation, cleaning or maintenance.
- Cleaning activity while the chamber is turned on.
- Operation of the chamber with a damaged housing or damaged power cord

- Continued operation of the chamber during an obvious malfunction
- Insertion of objects, particularly metallic objects, in louvers or other openings or slots on the chamber
- Human error (e.g. insufficient experience, qualification, stress, exhaustion, laziness)

To prevent these and other risks from incorrect operation, the operator shall issue operating instructions. Standard operating procedures (SOPs) are recommended.

## **1.11 Residual Risks**

The unavoidable design features of a chamber, as well as its proper field of application, can also pose risks, even during correct operation. These residual risks include hazards which, despite the inherently safe design, existing technical protective equipment, safety precautions and supplementary protective measures, cannot be ruled out.

Messages on the chamber and in the Operating Manual warn of residual risks. The consequences of these residual risks and the measures required to prevent them are listed in the Operating Manual. Moreover, the operator must take measures to minimize hazards from unavoidable residual risks. This includes, in particular, issuing operating instructions.

The following list summarizes the hazards against which this Operating Manual and the Service Manual warn, and specifies protective measures at the appropriate spots:

### **Unpacking, Transport, Installation**

- Sliding or tilting the chamber
- Setup of the chamber in unauthorized areas
- Installation of a damaged chamber
- Installation of a chamber with damaged power cord
- Inappropriate site of installation
- Missing protective conductor connection

### **Normal operation**

- Assembly errors
- Contact with hot surfaces on the housing
- Contact with hot surfaces in the interior and inside of doors
- Emission of non-ionizing radiation from electrical operating resources
- Contact with live parts in normal state

### **Cleaning and Decontamination**

- Penetration of water into the chamber
- Inappropriate cleaning and decontamination agents
- Enclosure of persons in the interior

### **Malfunction and Damage**

- Continued operation of the chamber during an obvious malfunction or outage of the heating system
- Contact with live parts during error status
- Operation of a unit with damaged power cord

## Maintenance

- Maintenance work on live parts.
- Execution of maintenance work by untrained/insufficiently qualified personnel
- Electrical safety analysis during annual maintenance not performed

## Trouble-shooting and Repairs

- Non-observance of warning messages in the Service Manual
- Trouble-shooting of live parts without specified safety measures
- Absence of a plausibility check to rule out erroneous inscription of electrical components
- Performance of repair work by untrained/insufficiently qualified personnel
- Inappropriate repairs which do not meet the quality standard specified by BINDER
- Use of replacement parts other than BINDER original replacement parts
- Electrical safety analysis not performed after repairs

## 1.12 Operating instructions

Depending on the application and location of the chamber, the operator of the chamber must provide the relevant information for safe operation of the chamber in a set of operating instructions.



Keep these operating instructions with the chamber at all times in a place where they are clearly visible. They must be comprehensible and written in the language of the employees.

## 1.13 Measures to prevent accidents

The operator of the chamber must observe the local and national regulations and take precautions to prevent accidents.

The manufacturer took the following measures to prevent ignition and explosions:

- **Indications on the type plate**  
See operating manual chap. 1.6.
- **Operating manual**  
An operating manual is available for each chamber.
- **Overtemperature monitoring**  
The chamber is equipped with a temperature display, which can be read from outside.  
The chamber is equipped with an additional safety controller (temperature safety device class 3.1 acc. to DIN 12880:2007). Visual and audible (buzzer) signals indicate temperature exceeding.
- **Safety, measurement, and control equipment**  
The safety, measuring, and control equipment is easily accessible.
- **Electrostatic charge**  
The interior parts are grounded.
- **Non-ionizing radiation**  
Non-ionizing radiation is not intentionally produced, but released only for technical reasons by electrical equipment (e.g. electric motors, power cables, solenoids). The machine has no permanent magnets. If persons with active implants (e.g. pacemakers, defibrillators) keep a safe distance (distance of field source to implant) of 30 cm, an influence of these implants can be excluded with high probability.

- **Protection against touchable surfaces**

Tested according to EN ISO 13732-1:2008.

- **Floors**

See operating manual chap. 3.4 for correct installation

- **Cleaning**

See operating manual chap. 10.3.

- **Examinations**

The chamber has been inspected by the “Deutsche Gesetzliche Unfallversicherung e.V. (DGUV) (German Social Accident Insurance (DGUV))” (German Social Accident Insurance (DGUV), Testing and Certification Body for Foodstuffs and Packaging Industry in DGUV Test) and bears the GS mark. (Not valid for UL chambers)

UL chambers only: The chamber is certified by Underwriters Laboratories Inc.® according to the standards UL 61010A-1, 1st Edition, UL 61010A-2-10, 1st Edition, CSA C22.2 No. 1010.1-92, IEC 1010-2-10.

## 2. Chamber description

BINDER incubators with forced convection BF / BF-UL are equipped with an electronic PID-controller with digital display. The temperature is indicated with an accuracy of a tenth of a degree.

The chambers are heated electrically and are ventilated by fan-assisted, forced-air circulation.

The APT.line™ preheating chamber system guarantees high level of spatial and time-based temperature precision, thanks to the direct and distributed air circulation into the interior. The fan supports exact attainment and maintenance of the desired temperature accuracy.

The chambers are regularly equipped with a temperature safety device according to DIN12880:2007 (chap. 7).

**Material:** The inner chamber, the pre-heating chamber and the inside of the doors are all made of stainless steel V2A (German material no. 1.4301, US equivalent AISI 304). The housing is RAL 7035 powder-coated. All corners and edges are also completely coated.

All chamber functions are easy and comfortable to use thanks to their clear arrangement. Major features are easy cleaning of all chamber parts and avoidance of undesired contamination.

The chambers are equipped with a serial interface RS 422 for computer communication, e.g. via the APT-COM™ 4 Multi Management Software (option, chap. 8.2). For further options, see chap. 12.5.

The chambers can be operated in a temperature range of 5 °C / 9 °F above ambient temperature up to +100 °C 212 °F.

## 2.1 Chamber overview

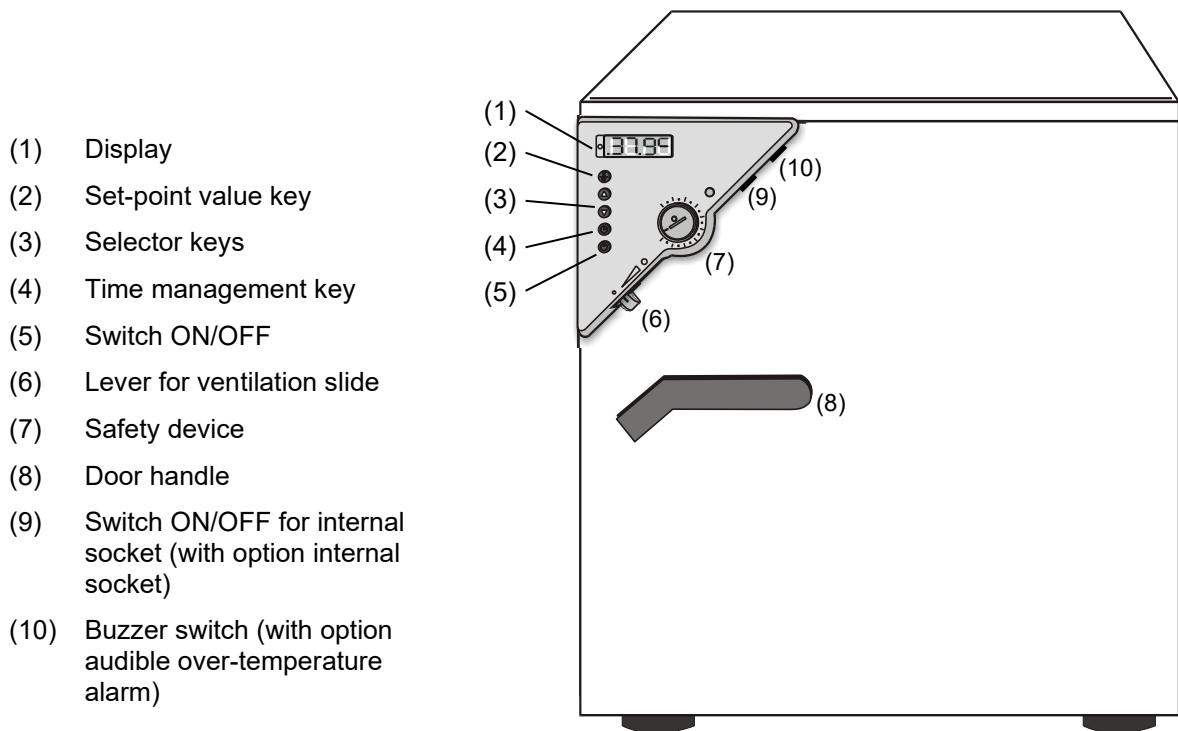

Figure 3: Incubator with forced convection BF / BF-UL





## 3. Completeness of delivery, transportation, storage, and installation

### 3.1 Unpacking, and checking equipment and completeness of delivery

After unpacking, please check the chamber and its optional accessories, if any, based on the delivery receipt for completeness and for transportation damage. Inform the carrier immediately if transportation damage has occurred.

The final tests of the manufacturer may have caused traces of the racks on the inner surfaces. This has no impact on the function and performance of the chamber.

Please remove any transportation protection devices and adhesives in/on the chamber and on the doors and take out the operating manuals and accessory equipment.

  	<div style="background-color: yellow; text-align: center; padding: 5px;">  <b>CAUTION</b> </div> <p><b>Risk of injury and damages by lifting heavy loads and by sliding or tilting of the chamber due to improper lifting.</b></p> <p><b>Injuries, damage to the chamber.</b></p> <ul style="list-style-type: none"> <li>⊘ Do NOT lift or transport the chamber using the door handle or the door.</li> <li>⊘ Do NOT lift chambers size 400 by hand</li> <li>➤ Lift chambers size 400 from the pallet using technical devices (fork lifter). Set the fork lifter only from the rear in the middle of the chamber. Make sure to place all the lateral supports of the chamber on the forks.</li> </ul>
---	--

If you need to return the chamber, please use the original packing and observe the guidelines for safe lifting and transportation (chap. 3.2).



For disposal of the transport packing, see chap. 11.1.





#### Note on second-hand chambers (Ex-Demo chambers):

Second-hand chambers have been used for a short time for tests or exhibitions. They are thoroughly tested before resale. BINDER ensures that the chamber is technically sound and will work flawlessly.

Second-hand chambers are marked with a sticker on the chamber door. Please remove the sticker before commissioning the chamber.

### 3.2 Guidelines for safe lifting and transportation

After operation please observe the guidelines for temporarily decommissioning the chamber (chap. 11.2).

  	 <b>CAUTION</b>
	<p><b>Risk of injury and damages by lifting heavy loads and by sliding or tilting of the chamber due to improper transportation.</b></p> <p><b>Injuries, damage to the chamber.</b></p> <ul style="list-style-type: none"> <li>➤ Transport the chamber only in its original packaging.</li> <li>➤ Secure the chamber with transport straps for transport.</li> <li>⊘ Do NOT lift or transport the chamber using the door handle or the door.</li> <li>⊘ Do NOT lift chambers size 400 by hand.</li> <li>➤ Place chambers size 400 using technical devices (fork lifter) on the transport pallet. Set the fork lifter only from the rear in the middle of the chamber. Make sure to place all the lateral supports of the chamber on the forks.</li> <li>➤ Transport chambers size 400 ONLY with the original transport pallet. Set the fork lifter only to the pallet. Without the pallet the chamber is in imminent danger of overturning.</li> </ul>

- Permissible ambient temperature range during transport: -10 °C up to +60 °C / 14 °F up to 140 °F.

You can order transport packing and pallets for transportation purposes from BINDER Service.

### 3.3 Storage

Intermediate storage of the chamber is possible in a closed and dry room. After operation, please observe the guidelines for temporary decommissioning (chap. 11.2).

- Permissible ambient temperature range during storage: -10 °C up to +60 °C / 14 °F up to 140 °F.
- Permissible ambient humidity: max. 70 % r.H., non-condensing



When after storage in a cold location you transfer the chamber to its warmer installation site, condensation may form. Before start-up, wait at least one hour until the chamber has attained ambient temperature and is completely dry.

### 3.4 Location of installation and ambient conditions

Set up the chamber on a flat, even surface, free from vibration and in a well-ventilated, dry location. Align the chamber using a spirit level. The site of installation must be capable of supporting the chamber's weight (see technical data, chap. 12.4). The chambers are designed for setting up inside a building (indoor use).

	NOTICE
	<p><b>Danger of overheating due to lack of ventilation.</b></p> <p><b>Damage to the chamber.</b></p> <ul style="list-style-type: none"> <li>⊘ Do NOT install the chamber in unventilated recesses.</li> <li>➤ Ensure sufficient ventilation for dispersal of the heat.</li> <li>➤ Observe the prescribed minimum distances when installing the chamber.</li> </ul>

Do not install or operate the chamber in potentially explosive areas.

	 <b>DANGER</b>
	<p><b>Danger of explosion due to combustible dusts or explosive mixtures in the vicinity of the chamber.</b></p> <p><b>Serious injury or death from burns and / or explosion pressure.</b></p> <ul style="list-style-type: none"> <li>⊘ Do NOT operate the chamber in potentially explosive areas.</li> <li>➤ KEEP explosive dust or air-solvent mixtures AWAY from the vicinity of the chamber.</li> </ul>

#### Ambient conditions

- Permissible ambient temperature range during operation: +18 °C up to +40 °C / 64.4 °F up to 104 °F. At elevated ambient temperature values, fluctuations in temperature can occur.

	<p>The ambient temperature should not be substantially higher than the indicated ambient temperature of +22 °C ± 3 °C / 71.6 °F ± 5.4 °F to which the specified technical data relate. For other ambient conditions, deviations from the indicated data are possible.</p>
--	---

- Permissible ambient humidity: 70 % r.H. max., non-condensing.
- Installation height: max. 3000 m / 9842 ft. above sea level.

#### Minimum distances

- When placing several chambers of the same size side by side, maintain a minimum distance of 160 mm / 6.30 in between each chamber.
- Wall distances: rear 100 mm / 3.9 in, sides 160 mm / 6.29 in.
- Spacing above the chamber of at least 100 mm / 3.9 in must also be accounted for.

#### Other requirements

To completely separate the chamber from the power supply, you must disconnect the power plug. Install the chamber in a way that the power plug is easily accessible and can be easily pulled in case of danger.

For the user there is no risk of temporary overvoltages in the sense of EN 61010-1:2010.



## 4. Installation of the equipment

### 4.1 Electrical connection

The chambers are supplied ready for connection. They come with a fixed power connection cable of at least 1800 mm / 70.87 in in length.

Model	Power plug	Nominal voltage ± 10% at the indicated power frequency	Current type
BF 400	Grounded plug	230 V at 50 Hz 230 V at 60 Hz	1N~
BF-UL 400	NEMA 5-15P	115 V at 60 Hz	1N~

- The domestic socket must also provide a protective conductor. Make sure that the connection of the protective conductor of the domestic installations to the chamber's protective conductor meets the latest technology. The protective conductors of the socket and plug must be compatible!

	 <b>DANGER</b>
	<p><b>Electrical hazard due to missing protective conductor connection.</b></p> <p><b>Deadly electric shock.</b></p> <ul style="list-style-type: none"> <li>➤ Make sure that the chamber's power plug and the power socket match and securely connect the electrical protective conductors of the chamber and the house installation.</li> </ul>

- Only use original connection cables from BINDER according to the above specification.  
UL chambers: Use only a UL Listed Power supply cord (UL category ELBZ), SJT 3x14 AWG (2.08 mm<sup>2</sup>); C13L. For outside USA use a certified power supply cord according to national requirements.
- Prior to connection and start-up, check the power supply voltage. Compare the values to the specified data located on the chamber's type plate (chamber front behind the door, bottom left-hand, chap. 1.6).

	<b>NOTICE</b>
	<p><b>Danger of incorrect power supply voltage due to improper connection.</b></p> <p><b>Damage to the chamber.</b></p> <ul style="list-style-type: none"> <li>➤ Check the power supply voltage before connection and start-up.</li> <li>➤ Compare the power supply voltage with the data indicated on the type plate.</li> </ul>

- When connecting, please observe the regulations specified by the local electricity supply company as well as the local or national electrical regulations (VDE directives for Germany).
- Observe a sufficient current protection according to the number of devices that you want to operate. We recommend the use of a residual current circuit breaker.
- Pollution degree (acc. to IEC 61010-1): 2
- Over-voltage category (acc. to IEC 61010-1): II

See also electrical data (chap.12.4).



	<p>To completely separate the chamber from the power supply, you must disconnect the power plug. Install the chamber in a way that the power plug is easily accessible and can be easily pulled in case of danger.</p>
---	--

## 4.2 Connection to a suction plant (optional)

When directly connecting a suction plant the spatial temperature exactitude, the heating-up and the recovering times and the maximum temperature will be negatively influenced. So no suction plant should be directly connected to the exhaust duct.

	<p>Active suction from the chamber must only be effected together with extraneous air. Perforate the connecting piece to the suction device or place an exhaust funnel at some distance to the exhaust duct.</p>
---	--

The exhaust duct on the chamber rear will become hot during operation.

	 <b>CAUTION</b>
	<p><b>Danger of burning by touching hot chamber parts during operation.</b></p> <p><b>Burns.</b></p> <ul style="list-style-type: none"> <li>⊘ Do NOT touch the exhaust duct on the chamber rear during operation.</li> </ul>

## 5. Start up

### 5.1 Turning on the chamber



Warming chambers may release odors in the first few days after commissioning. This is not a quality defect. To reduce odors quickly we recommend heating up the chamber to its nominal temperature for one day and in a well-ventilated location.

1. Insert the plug into an appropriate socket (chap. 4.1).

The green "Standby" LED illuminates.



2. Press  until the display lights up.

The controller is now in normal display (actual value display).

If the chamber is operating (time functions "Continuous operation", or "Timer operation" with the set time just running down chap. 6.3), the **actual temperature value** (example: 21.8 °C) is displayed



If the controller is in time function "Timer operation" with no time programmed or the set time run-off (chap. 6.3), the chamber is inactive (no heating). The display alternately shows the **actual temperature value** (example: 21.8 °C) and "**tOff**":

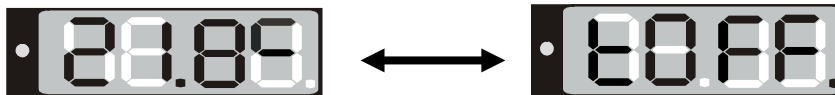

Adjust the temperature safety device following any changes of the set-point (chap. 7).

### 5.2 Heating operation display

The heating is active as soon as the red heating control light in the bottom right corner of the display slowly begins to flash depending on the heat requirement (example: 70 °C):



### 5.3 Air change

Opening the air flap in the exhaust duct serves to adjust the air change.

Without connecting a suction plant:

- If the air flap is open and the fan is operating, fresh air comes in via aeration gaps.
- If the air flap is completely open, the spatial temperature accuracy can be negatively influenced.

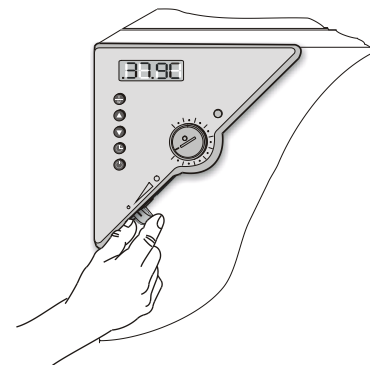

Figure 4: Adjusting the air flap

## 6. Controller setting

### 6.1 Display / entry of temperature and ventilation set-points (without ramp function)



The chamber is operating, the controller is in normal display (actual value display). The actual temperature value (example: 21.8 °C) is displayed:

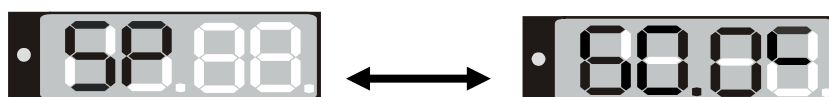

1. Press  button

The display shows alternately "SP" and the previous **temperature set-point** (example: 60 °C):



2. With the   buttons enter a set-point value between 0 and 100.



 The desired temperature set-point can be selected in a temperature range from 5 °C / 9 °F above room temperature up to 100 °C / 212 °F.

Wait 2 seconds until the entered temperature value is taken over (display flashing once).

3. Press  button to proceed to the fan speed entry.

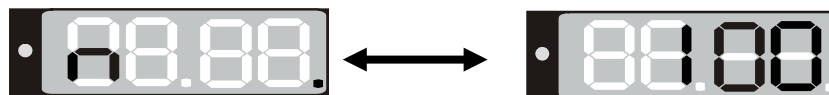
The display shows alternately "n" and the previous **fan speed set-point** (example: 100%):



4. Set the desired fan speed with the   buttons.

 The fan speed can be set to a value between 0% and 100%.

Wait 2 seconds until the entered value is taken over (display flashing once).

5. Press  button to return to normal display (actual value display) (automatically after approx. 30 seconds).

 Adjust the temperature safety device following any changes of the set-point (chap. 7).

## 6.2 Display / entry of temperature and ventilation set-points (with selected temperature ramp)

If previously a temperature ramp value has been selected (chap. 6.4.2):

Press button  in normal display / actual value display during ramp operation to have displayed the actual ramp temperature set-point changing according to the selected gradient in addition to the entered final set-points for temperature and fan speed.

The chamber is operating, the controller is in normal display (actual value display). The **actual temperature value** (example: 21.8 °C) is displayed:



1. Press  button

The display shows alternately "SPr" and the **actual temperature ramp set-point** changing according to the selected gradient (example: 42.7 °C):

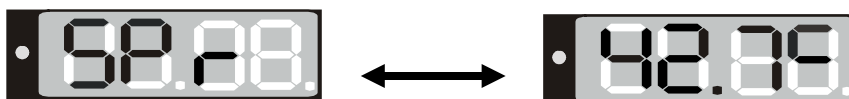



This ramp set-point is only displayed, not adjustable.

2. Press  button

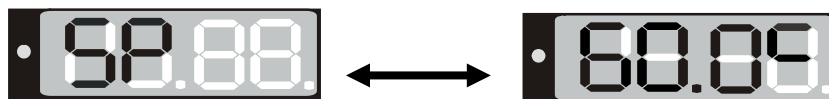
The display shows alternately "SP" and the previous **temperature set-point** (example: 60 °C):



3. With the   buttons enter a set-point value between 0 and 100.



 The desired temperature set-point can be selected in a temperature range from 5 °C / 9 °F above room temperature up to 100 °C / 212 °F.

Wait 2 seconds until the entered temperature value is taken over (display flashing once).

4. Press  button to proceed to the fan speed entry.

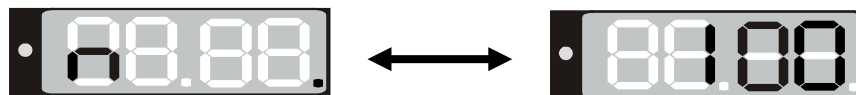
The display shows alternately "n" and the previous **fan speed set-point** (example: 100%):



5. Set the desired fan speed with the   buttons

 The fan speed can be set to a value between 0% and 100%.

Wait 2 seconds until the entered value is taken over (display flashing once).

6. Press  button to return to normal display / actual value display (automatically after approx. 30 seconds).

 Adjust the temperature safety device following any changes of the set-point (chap. 7).

### 6.3 Time functions: Continuous operation and Timer operation

Press the time management button .

The timer indicates its current time function. There are two possible time functions:

#### Continuous operation

The display shows alternately "t1" (time function) and the time function "Continuous operation" "t inf":



The heating is permanently active, independent of the timer setting.

#### Timer operation

The display shows alternately "t1" (time function) and the running-down time or "tOff":

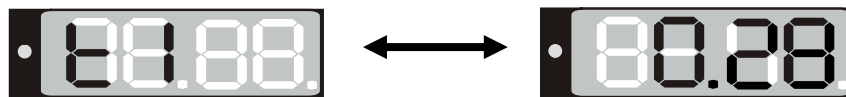

**Remaining time** (example: 28 Min.) – **Timer running down**

Heating activity depending on the entered time value and the timer function selected in the user menu (chap.6.4.4)

or

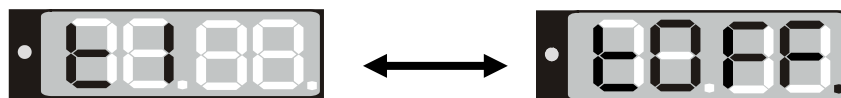

**Timer not programmed or run-down "t off"**

If the timer has run-down, the chamber's behavior depends on the pre-selected timer function (chap. 6.4.4).

Press  button to return to normal display (actual value display) (automatically after approx. 30 seconds).

### 6.3.1 Switching between Continuous operation and Timer operation

Press the time management button .

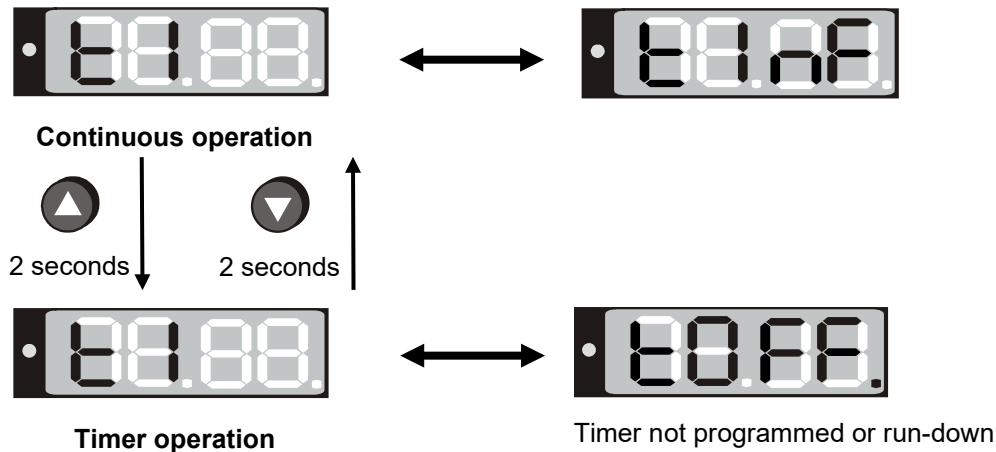

The controller displays the actual time function. In time function "Continuous operation", "t1" and "t inf" are displayed alternately. In time function "Timer operation", "t1" is displayed alternately with the running-down time or "tOff".

If in time function "Timer operation" the Timer is just running off ("t1" displayed alternately with the running-down time) the timer must at first be set to Zero (chap. 6.3.3). Now "t1" is displayed alternately with "tOff", and the controller can be changed to time function "Continuous operation".



Press  button to return to normal display / actual value display (automatically after approx. 30 sec).

### 6.3.2 Continuous operation

1. Press the time management button . The timer indicates its current time function.
2. If necessary, switch to Continuous operation by button .

The display shows alternately "t1" and the time function "Continuous operation" "t inf":





3. Press  button to return to normal display (actual value display) (automatically after approx. 30 seconds).

The **actual temperature value** (example: 21.8 °C) is displayed:



Now the controller operates with the entered set-points (chap. 6.1) in continuous operation. The heating is permanently active, independent of the timer setting.

To cancel Continuous operation, proceed accordingly:

1. Press the time management button .
2. Switch to Timer operation by pressing down button  for 2 seconds (chap. 6.3.1).



### 6.3.3 Setting the timer values

1. Press the time management button . The controller indicates its current time function.

2. If necessary, switch to timer operation by button .

The display alternately shows "t1" and the running-down time or "tOff":

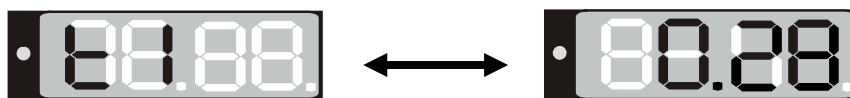



or

Remaining time (example: 28 minutes) – Timer running down



Timer not programmed or run-off "t off"

3. Set the desired time [hh.mm] with the arrow buttons  .

4. Wait 2 seconds until the entered temperature value is taken over (display flashing once).

The display alternately shows "t1" and the set time now running down.

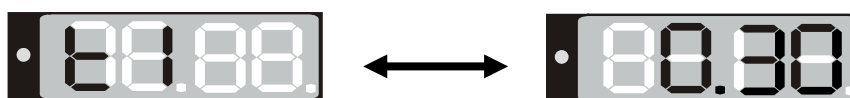

The time directly begins to run off after taking-over of the entered value. The use of this time depends on the timer function selected in the user menu (chap. 6.4.4).

5. Press button  to return to normal display (actual value display) (automatically after approx. 30 seconds).

The **actual temperature value** is displayed (example: 21.8 °C):



The controller operates with the entered set-points (chap. 6.1) until run-down of the set time. Heating activity depending on the entered time value and the timer function selected in the user menu (chap.6.4.4)

To know the remaining timer time or, if appropriate, to modify it, press the time management button  in normal display (actual value display).

The display alternately shows "t1" and running-down time:



After the set time has run down the display alternately shows the **actual temperature value** (example: 21.8 °C) and "tOff":

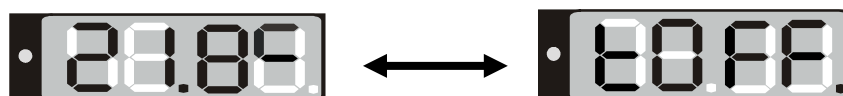

Now the heating is inactive. The fan continues operating.

## 6.4 User level settings

By pressing down button  in normal display (actual value display) for 5 sec, you enter the user menu. Settings in this menu affect controller operation.

### User level overview:

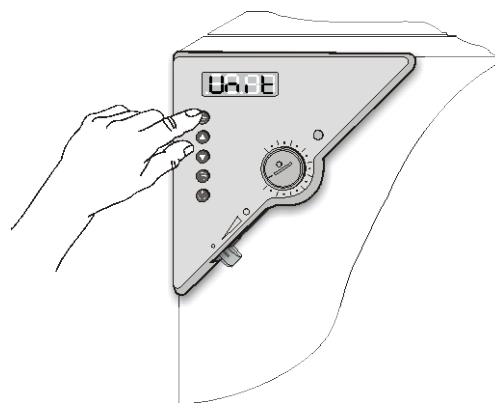
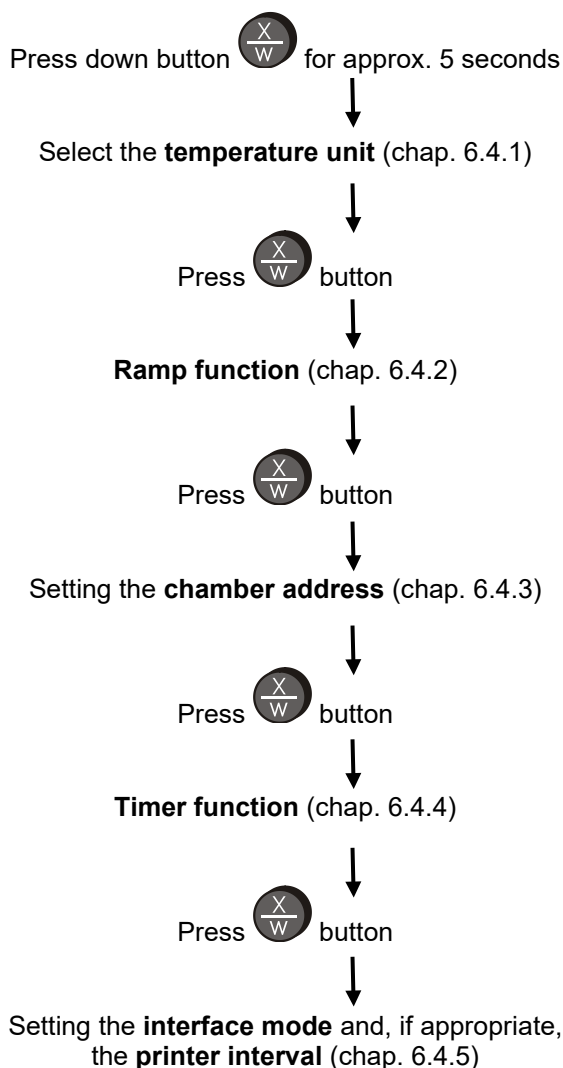



Figure 5: Press down  button for approx. 5 seconds

Press button  to return to normal display with display of the temperature set-point.

**Or:**

After approx. 30 seconds the controller automatically returns to normal display / actual value display.

All settings can be carried out independently (as described in the individual sections) or one after the other during one single process.



The defined parameters are not deleted when the main power switch is turned off or in case of power failure.



### 6.4.1 Temperature unit change between degrees Celsius °C and degrees Fahrenheit °F

If required, the temperature display can be changed as follows:

1. Press down  button for approx. 5 seconds.

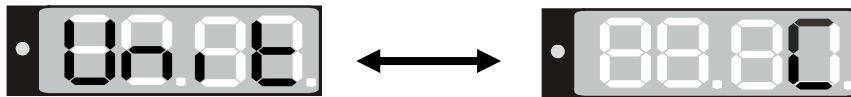
The display alternately shows “unit” and the actual setting of the **temperature unit**:



2. Use the   buttons to set the required unit.
3. The set unit is automatically adopted after 2 seconds.

	C = degrees Celsius	0 °C = 31 °F	Conversion: [Value in °F] = [Value in °C] * 1.8 + 32
	F= degrees Fahrenheit	100 °C = 212 °F	

When specifying the set point ramp (see chap. 6.4.2) this setting is accordingly taken as the basis.

	If the unit is changed, the temperature set-point and limits are converted accordingly.
---	---

### 6.4.2 Entering a temperature ramp

Temperature ramps can be programmed in order to extend heating up times. This may be necessary in some cases, in order to prevent temperature stresses in the material during the heating up phase. Temperature ramps should only be used if required. The use of temperature ramps may result in the heating up times being considerably slowed down.

The entry in °C/min or in °F/min meaning the nominal value gradient and limits the maximum temperature increase to this value. Due to the heat and evaporation energy assumed by the drying material, smaller temperature gradients may also result.

A temperature ramp proceeds from the previously entered to a new set-point. The temperature must have adjusted to the start set-point. Enter settings in 3 steps:

1. Enter set-point of ramp start temperature. Let temperature adjust to this set-point temperature.
2. Set the ramp to the desired gradient in °C/min or in °F/min.

You can enter a gradient value from 0.0 up to 1.0.

Setting the gradient to 0.0 means ramp function off = maximum heating power.

Setting the gradient to another value, e.g., 0.3, means the chamber will try to heat up with a speed of 0.3 °C/min.

A heat-up rate of 0.4 °C/minute can be regarded as a realistic maximum.

3. Enter set-point (final ramp temperature).

The ramp should only be set if required. The setting “0.0” means ramp function turned off. The chamber is being heated at maximum heat output.

1. Press down  button for approx. 5 seconds.

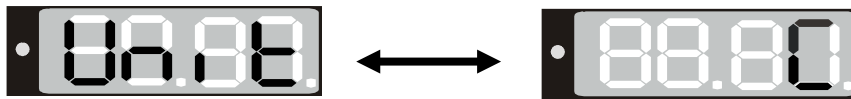

The display alternately shows “unit” and the temperature unit:

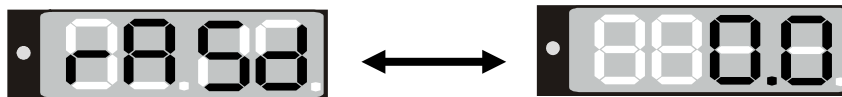

2. Press again button .

The display alternately shows “rASd” and the actual setting of the **set-point gradient**:



3. Set the desired ramp gradient with buttons   (set-point gradient in °F or °C acc. to setting in chap. 6.4.1).
4. The set value is automatically adopted after 2 seconds.

During ramp operation the actual set-point (SPr) continually rises in accordance to the entered gradient from the previously entered set-point to the new one (SP). The actual value follows the set-point value.

About set-point display during ramp operation see chap. 6.2.

### 6.4.3 Chamber addressing

If several chambers are networked with a PC via the APT-COM™ 4 Multi Management Software (option, chap. 8.2), each chamber must be allocated a unique address. Addressing takes place on the chamber controller as follows:

1. Press down  button for approx. 5 seconds.

The display alternately shows “unit” and the temperature unit:

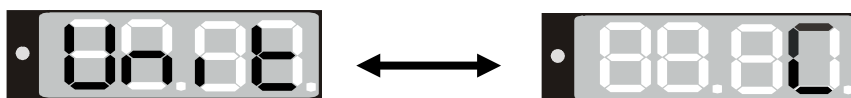

2. Press again button .

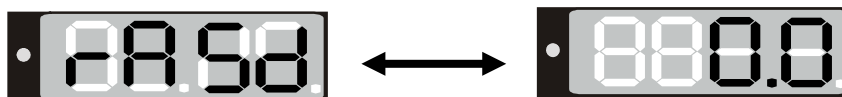

The display alternately shows “rASd” and the set-point gradient:

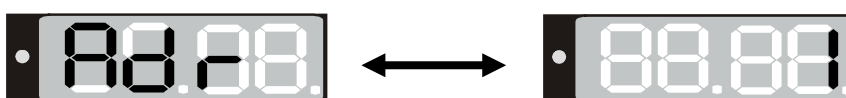

3. Press again button .

The display alternately shows “Adr” and the actual setting of the **chamber address**:



4. Set the required address with buttons  .



You can enter address values between 1 and 30.

5. The set value is automatically adopted after 2 seconds.

#### 6.4.4 Selecting the timer function

The chamber provides three different timer functions:

- **Delayed off** (setting “0”)

After the defined time has elapsed, the heating is turned off.

- **Temperature-controlled delayed off** (setting “1”)

The defined time only begins to run when the current value is 1 °C below the set point. After the defined time has expired, the heating is turned off.

- **Delayed on** (setting “2”)

After the time set has passed, the heating is turned on and remain in continuous operation.

1. Press down  button for approx. 5 seconds.

The display alternately shows “unit” and the temperature unit:

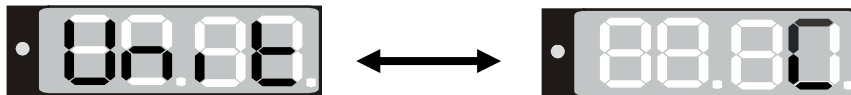

2. Press again button .

The display alternately shows “rASd” and the set-point gradient:

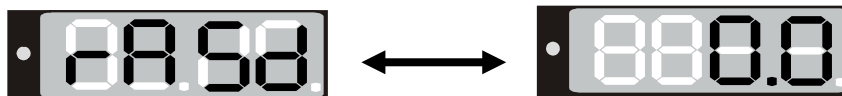

3. Press again button .



The display alternately shows “Adr” and the chamber address:

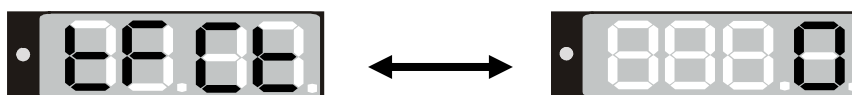

4. Press again button .

The display alternately shows “tFct” and the actual setting of the timer function:





5. Set the desired timer function 0, 1 or 2 with buttons  .
6. The set value is automatically adopted after 2 seconds.

### 6.4.5 Setting the interface mode and, if appropriate, the printer interval

1. Press down  button for approx. 5 seconds.

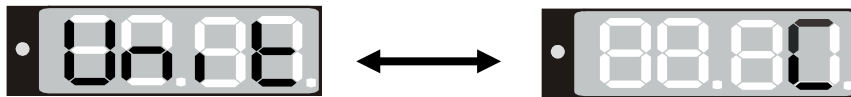
The display alternately shows "unit" and the temperature unit:



2. Press again button .

The display alternately shows "rASd" and the set-point gradient:

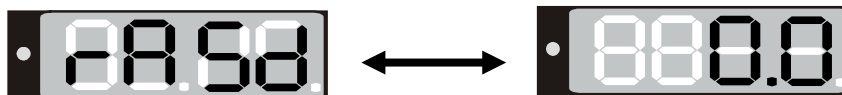

3. Press again button .

The display alternately shows "Adr" and the chamber address:



4. Press again button .

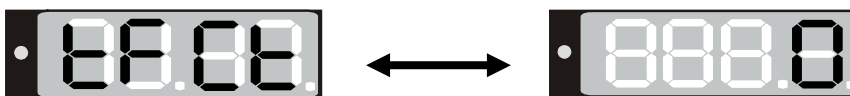

The display alternately shows "tFct" and the timer function:

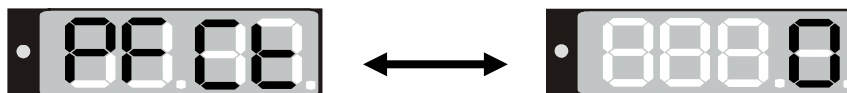

5. Press again button .

The display alternately shows "PFct" and the actual setting of the **interface mode**:



6. Set the desired interface mode with buttons  .

**Settings: Modbus = "0" printer = "1"**

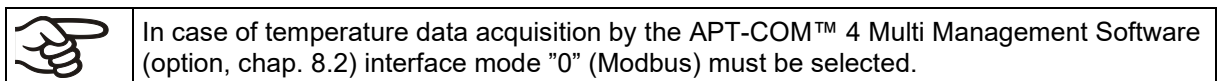



The setting is automatically adopted after 2 seconds.

If interface mode "1" (printer) has been selected, the printer interval for the automatic output can be set in an additional menu step:

7. Press again button .

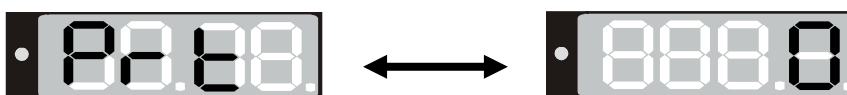
The display alternately shows "Prt" and in the entry level the actual setting of the **printer interval**:



8. Set the desired value from 0 to 255 with buttons  .



**The printer intervals via the RS 422 interface can be set between 1 and 255 min. Setting “0” signifies the printer interval set to off.**

A protocol printer records the temperature data in the set interval.







9. The set value is automatically adopted after 2 seconds.

## 6.5 Temperature programming example

The chamber shall heat up to a temperature of 50 °C, maintain this temperature for three hours and then turn off.

1. In normal display press down button  for 5 sec and then several times until “tFCt” is displayed  
-- Select timer function “1” = “temperature-dependent delayed off” (chap. 6.4.4)
2. In normal display press button .  
-- Enter the set point “50.0” (chap. 6.1)
3. In normal display press the time management button . The controller displays the actual time function.  
-- If necessary select the time function “Timer operation” (chap. 6.3.1)  
-- In the entry level enter the desired time “3.00” (chap. 6.3.3)

## 6.6 General notes

	Approx. 30 sec. after the last entry the controller returns to normal display (actual value display).
	The functions set-point entry (chap. 6.1), time functions (chap. 6.3), and calling up the user menu (chap. 6.4) can only be selected from normal display (actual value display).
	When selecting the functions set-point entry and time functions, and when selecting the user menu functions, the respective button  or  must be pressed down for a about 1 sec. Shorter pressing will be ignored by the controller.
	After a power failure, the timer returns to the previous status. A remaining time, if any, will continue running down.
	Adjust the temperature safety device following any changes of the set-point (chap. 7).

## 7. Temperature safety device class 3.1 (DIN 12880)

The temperature safety device class 3.1 serves to protect the chamber, its environment and the charging material from exceeding the maximum permissible temperature.

Please observe the regulations applicable to your country (for Germany: DGUV guidelines 213-850 on safe working in laboratories, issued by the employers' liability insurance association).

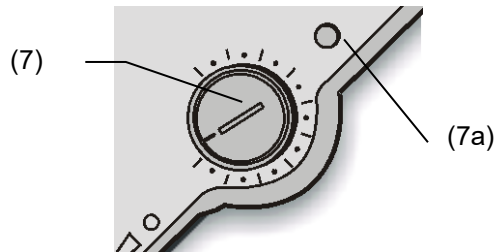

Figure 6: Temperature safety device class 3.1

### Function:

The temperature safety device is functionally and electrically independent of the temperature control system and if an error occurs it performs a regulatory function.

If you turn the control knob (7) to its end-stop (position 10), the safety device class 3.1 protects the chamber. If you set it to a temperature a little above the controller's set-point temperature, it protects the charging material.

If the safety device has taken over control (identifiable by the red alarm lamp (7a) lighting up and, in case of the option audible alarm with activated buzzer (chap. 8.1), by the buzzer sounding), proceed as follows:

- Disconnect the chamber from the power supply.
- Have an expert examine and rectify the cause of the fault.
- Restart the chamber (see chap. 5).

### Adjustment:

In order to check at which temperature the safety device class 3.1 responds, turn on the chamber and set the desired set-point on the temperature controller

The sections of the scale from 1 to 10 correspond to the temperature range from 0 °C / 32 °F to 120 °C / 248 °F and serve as a setting aid.

1. Turn the control knob (7) of the safety device with a coin to its end-stop (chamber protection).
2. When the set point is reached, turn the control knob (7) to its trip point (turn it counter-clockwise)
3. The trip point is identifiable by the red alarm lamp (7a) lighting up.

With the option audible alarm and the buzzer activated (chap. 8.1), the buzzer sounds as an additional signal. You can turn it off with switch (10).

4. The optimum setting for the safety thermostat class 3.1 is obtained by turning the control knob clockwise by approximately one scale division, which leads to extinguish the red alarm lamp (7a).

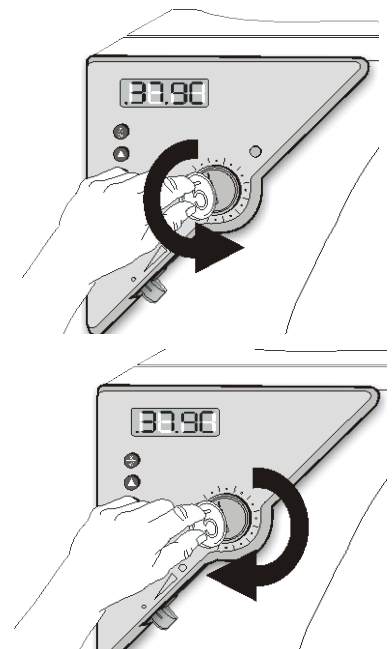

Check the setting regularly and adjust it following any changes of the set-point.



### Function check:

Check the temperature safety device class 3.1 at appropriate intervals for its functionality. It is recommended that the authorized operating personnel should perform such a check, e.g., before starting a longer work procedure.

## 8. Options

### 8.1 Disconnectable audible over-temperature alarm (option)

This option allows to activate an audible signal with the buzzer switch (10):

Position 0 = buzzer off

Position 1 = buzzer active

If the buzzer is activated, an audible signal sounds when the limit temperature set at the temperature safety device class 3.1 (chap. 7) is exceeded, this happens in addition to the red alarm pilot lamp (7a) lighting up. The buzzer can be turned off using the buzzer switch (10).



Turning off the audible alarm does not influence the safety device's regulatory function. Proceed as described in chap. 7.

### 8.2 APT-COM™ 4 Multi Management Software (option)

The chamber is regularly equipped with a serial interface RS 422 that can connect the BINDER APT-COM™ 4 Multi Management Software. The connection to a computer is established using the BF interface via an interface converter RS 422 / RS 232.



Make sure that the interface mode is correctly set to "0" = "Modbus" in the user level (chap. 6.4.5).

The actual temperature, and fan speed values are given at adjustable intervals. Up to 100 chambers can be cross linked. For further information, refer to the APT-COM™ 4 operating manual.

Pin allocation of the RS 422 interface:

pin 2:	RxD (+)
pin 3:	TxD (+)
pin 4:	RxD (-)
pin 5:	TxD (-)
pin 7:	Ground



If several chambers are to be recorded via a single computer, each chamber must be allocated a unique address. Addressing is performed via the chamber controller (chap. 6.4.3).

### 8.3 Analog output for temperature (option)

With this option the chamber is equipped with an analog output 4-20 mA for temperature. This output permits transmitting data to external data registration systems or devices.

The connection is carried out as a DIN socket at the rear of the chamber as follows:

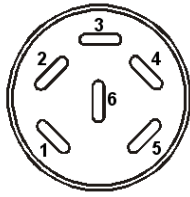

### ANALOG OUTPUT 4-20 mA DC

PIN 1: temperature –  
PIN 2: temperature +

#### Temperature range:

0 °C up to +100 °C / 32 °F up to 212 °F

A suitable DIN plug is enclosed.

Figure 7: Pin allocation of DIN socket for option analogue outputs

## 8.4 Additional Pt100 temperature sensor (option)

An additional fixed or flexible temperature sensor Pt100 permits measuring the chamber temperature (fixed Pt100) or the temperature of the charging material (flexible Pt100) by means of an independent measuring system with Pt100 entry. The sensor top protective tube of the flexible Pt100 can be immersed into liquid substances.

#### Technical data of the Pt100 sensor:

- Three-wire technique
- Class B (DIN EN 60751)
- Temperature range up to 320 °C / 608 °F
- Stainless steel protective tube with a length of 45 mm / 1.8 in, material no. 1.4501

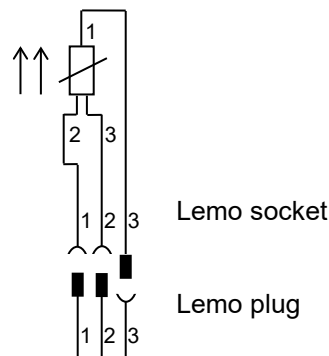



Figure 8: Option temperature sensor Pt100

## 9. Cleaning and decontamination

Clean the chamber after each use in order to prevent potential corrosion damage by ingredients of the loading material.

Prior to renewed startup, allow the chamber to completely dry after all cleaning and decontamination measures.

	 <b>DANGER</b>
	<p><b>Electrical hazard by water entering the chamber.</b> <b>Deadly electric shock.</b></p>
	<p>⊘ Do NOT spill water or cleaning agents over the inner and outer chamber surfaces. ⊘ Do NOT put ANY cleaning aids (cloth or brush) into slots or openings on the chamber.</p> <p>➤ Before cleaning, disconnect the power plug. Let the chamber cool down to ambient temperature. ➤ Completely dry the chamber before turning it on again.</p>

## 9.1 Cleaning

Disconnect the chamber from the power supply before cleaning. Disconnect the power plug.

	The interior of the chamber must be kept clean. Thoroughly remove any residues of. charging material.
---	---

Wipe the surfaces with a moistened towel. In addition, you can use the following cleaning agents:

Exterior surfaces inner chamber shelves door gaskets	Standard commercial cleaning detergents free from acid or halides. Alcohol based solutions. We recommend using the neutral cleaning agent Art. No. 1002-0016.
Instrument panel	Standard commercial cleaning detergents free from acid or halides. We recommend using the neutral cleaning agent Art. No. 1002-0016.
Zinc coated hinge parts rear chamber wall	Standard commercial cleaning detergents free from acid or halides. Do NOT use a neutral cleaning agent on zinc coated surfaces.

Do not use cleaning agents that may cause a hazard due to reaction with components of the chamber or the charging material. If there is doubt regarding the suitability of cleaning products, please contact BINDER service.

	We recommend using the neutral cleaning agent Art. No. 1002-0016 for a thorough cleaning. Any corrosive damage that may arise following use of other cleaning agents is excluded from liability by BINDER GmbH. Any corrosive damage caused by a lack of cleaning, is excluded from liability by BINDER GmbH.
---	---

	<p style="text-align: center;"><b>NOTICE</b></p> <p><b>Danger of corrosion by using unsuitable cleaners.</b> <b>Damage to the chamber.</b></p> <ul style="list-style-type: none"> <li>Ø Do NOT use acidic or chlorine cleaning detergents.</li> <li>Ø Do NOT use a neutral cleaning agent on other kind of surfaces e.g., the zinc coated hinge parts or the rear chamber wall.</li> </ul>
---	--

	For surface protection, perform cleaning as quickly as possible. After cleaning completely remove cleaning agents from the surfaces with a moistened towel. Let the chamber dry.
---	--



	Soapsuds may contain chlorides and must therefore NOT be used for cleaning.
---	---

	With every cleaning method, always use adequate personal safety controls.
---	---

Following cleaning, leave the chamber door open or remove the access port plugs.

	The neutral cleaning agent may cause health problems in contact with skin and if ingested. Follow the operating instructions and safety hints labeled on the bottle of the neutral cleaning agent.
---	--

Recommended precautions: To protect the eyes use sealed protective goggles. Wear gloves. Suitable protective gloves in full contact with media: butyl or nitrile rubber, penetration time >480 minutes.

	<div style="background-color: yellow; text-align: center; padding: 5px;">  <b>CAUTION</b> </div> <p><b>Danger of chemical burns through contact with skin or ingestion of the neutral cleaning agent.</b></p> <p><b>Skin and eye damage. Environmental damage.</b></p> <ul style="list-style-type: none"> <li>⊘ Do not ingest the neutral cleaning agent. Keep it away from food and beverages.</li> <li>⊘ Do NOT empty the neutral cleaning agent into drains.</li> <li>➤ Wear protective gloves and goggles.</li> <li>➤ Avoid skin contact with the neutral cleaning agent.</li> </ul>
---	---

## 9.2 Decontamination / chemical disinfection

The operator must ensure that proper decontamination is performed in case a contamination of the chamber by hazardous substances has occurred.

Disconnect the chamber from the power supply prior to decontamination. Pull the power plug.

Do not use decontamination agents that may cause a hazard due to reaction with components of the device or the charging material. If there is doubt regarding the suitability of cleaning products, please contact BINDER service.

You can use the following disinfectants:

Inner chamber	Standard commercial surface disinfectants free from acid or halides. Alcohol based solutions. We recommend using the disinfectant spray Art. No. 1002-0022.
---------------	---

	For chemical disinfection, we recommend using the disinfectant spray Art. No. 1002-0022. Any corrosive damage that may arise following use of other disinfectants is excluded from liability by BINDER GmbH.
---	---

	With every decontamination / disinfection method, always use adequate personal safety controls.
---	---



In case of impurity of the interior with biological or chemical hazardous material, there are two possible procedures depending on the type of contamination and of the charging material.

Spray the inner chamber with an appropriate disinfectant.

- (1) Before start-up, the chamber must be absolute dry and ventilated, because explosive gases may form during the decontamination process.
- (2) If necessary, have strongly contaminated inner chamber parts removed by an engineer for cleaning, or have them exchanged. Sterilize the inner chamber parts in a sterilizer or autoclave.

	In case of eye contact, the disinfectant spray may cause eye damage due to chemical burns. Follow the operating instructions and safety hints labeled on the bottle of the disinfectant spray.
---	--

Recommended precautions: To protect the eyes use sealed protective goggles.

	<div style="background-color: yellow; text-align: center; padding: 5px;">  <b>CAUTION</b> </div> <p><b>Danger of chemical burns through eye contact with the disinfectant spray.</b></p> <p><b>Eye damage. Environmental damage</b></p> <ul style="list-style-type: none"> <li>∅ Do NOT empty the disinfectant into drains.</li> <li>➤ Wear protective goggles.</li> </ul>
---	---

	<p>After using the disinfectant spray, allow the chamber to dry thoroughly, and aerate it sufficiently.</p>
---	---

## 10. Maintenance and service, troubleshooting, repair, testing

### 10.1 General information, personnel qualification

- **Maintenance**

See chap. 10.2

- **Simple troubleshooting**

Chap. 10.3 describes troubleshooting by operating personnel. It does not require technical intervention into the chamber, nor disassembly of chamber parts.

For personnel requirements please refer to chap. 1.1.

- **Detailed troubleshooting**

If errors cannot be identified with simple troubleshooting, further troubleshooting must be performed by BINDER Service or by BINDER qualified service partners or technicians, in accordance with the description in the Service Manual.

For personnel requirements please refer to the Service Manual.

- **Repair**

Repair of the chamber can be performed by BINDER Service or by BINDER qualified service partners or technicians, in accordance with the description in the Service Manual.



After maintenance, the chamber must be tested prior to resuming operation.

- **Electrical testing**

To prevent the risk of electrical shock from the electrical equipment of the chamber, an annual repeat inspection as well as a test prior to initial startup and prior to resuming operation after maintenance or repair, are required. This test must meet the requirements of the competent public authorities. We recommend testing under EN 50678:2020 / EN 50699:2020 in accordance with the details in the Service Manual.

For personnel requirements please refer to the Service Manual.

## 10.2 Maintenance intervals, service

 	 <b>DANGER</b>
	<p><b>Electrical hazard during live maintenance work.</b></p> <p><b>Deadly electric shock.</b></p> <ul style="list-style-type: none"> <li>Ø The chamber must NOT become wet during operation or maintenance works.</li> <li>Ø Do NOT remove the rear panel of the chamber.</li> <li>➤ Disconnect the chamber before conducting maintenance work. Disconnect the power plug.</li> <li>➤ Make sure that all maintenance work will be conducted by licensed electricians or experts authorized by BINDER.</li> </ul>

Ensure regular maintenance work is performed at least once a year and that the legal requirements are met regarding the qualifications of service personnel, scope of testing and documentation.

	The warranty becomes void if maintenance work is conducted by non-authorized personnel.
---	---

	Replace the door gasket only when cold. Otherwise, the door gasket may become damaged.
---	--

We recommend taking out a maintenance agreement. Please consult BINDER Service.

BINDER telephone hotline:	+49 (0) 7462 2005 555
BINDER fax hotline:	+49 (0) 7462 2005 93555
BINDER e-mail hotline:	customerservice@binder-world.com
BINDER service hotline USA:	+1 866 885 9794 or +1 631 224 4340 x3 (toll-free in the USA)
BINDER service hotline Asia Pacific:	+852 390 705 04 or +852 390 705 03
BINDER service hotline Russia and CIS	+7 495 988 15 16
BINDER Internet website	<a href="http://www.binder-world.com">http://www.binder-world.com</a>
BINDER address	BINDER GmbH, post office box 102, D-78502 Tuttlingen

International customers, please contact your local BINDER distributor.

## 10.3 Simple troubleshooting

Defects and shortcomings can compromise the operational safety of the chamber and can lead to risks and damage to equipment and persons. If there is a technical fault or shortcoming, take the chamber out of operation and inform BINDER Service. If you are not sure whether there is a technical fault, proceed according to the following list. If you cannot clearly identify an error or there is a technical fault, please contact BINDER Service.

	Only qualified service personnel authorized by BINDER must perform repair. Repaired chambers must comply with the BINDER quality standards.
---	---

Fault description	Possible cause	Required measures
<b>General</b>		
Chamber without function.	No power supply.	Check connection to power supply.
	Wrong voltage.	Check power supply for correct voltage (chap. 4.1).
	Chamber fuse has responded.	Check chamber fuse and replace it if appropriate. If it responds again, contact BINDER service.
	Controller defective.	Contact BINDER service.
<b>Temperature</b>		
Set-point temperature is not reached after specified time.	Chamber door not properly closed.	Completely close chamber door.
	Door gasket defective.	Replace door gasket,
	Controller not adjusted.	Calibrate and adjust controller.
	Wrong voltage.	Check power supply for voltage of 115V or 230V.
Chamber heating permanently, set-point not held.	Controller defective.	Contact BINDER service.
	Pt 100 sensor defective.	
	Semiconductor relay defective	
	Controller not adjusted.	Calibrate and adjust controller.
Chamber doesn't heat up. Red heating control light in the display is lit.	Heating element defective.	Contact BINDER service.
	Semiconductor relay defective.	
Chamber doesn't heat up. Red heating control light in the display is not lit. Controller display working.	Timer run off.	Program the timer or change to time function Continuous operation (chap. 6.3).
	Semiconductor relay defective.	Contact BINDER service.
	Controller defective.	
Temperature inside the chamber too high, Red alarm pilot lamp of safety device (7a) is lit.	Safety device class 3.1 has responded.	Check the settings of the temperature set-point and of the safety device class 3.1 (chap. 7).
Deviations from the indicated heating-up times.	Chamber fully loaded.	Charge the oven less or consider longer heating-up times.
<b>Fan</b>		
The fan doesn't turn or turns too slowly.	Fan speed set too low	Set the fan speed to 100%.
	Fan defective.	Contact BINDER service.
<b>Controller</b>		
Chamber without function, only the green "stand-by" LED is lit	Chamber in stand-by mode.	Press down the ON/OFF button (5) until the display lights up.
Message „1999" in the controller display.	Sensor rupture between sensor and controller.	Contact BINDER service.
The controller returns to Normal Display from any level.	No button was hit for more than approx. 30 sec.	Repeat entries, enter the values rapidly.

## 10.4 Sending the chamber back to BINDER GmbH

If you return a BINDER product to us for repair or any other reason, we will only accept the product upon presentation of an authorization number that has previously been issued to you. An **authorization number** (RMA number) will be issued after receiving your complaint either in writing or by telephone **prior** to your sending the BINDER product back to us. The authorization number will be issued following receipt of the information below:

- BINDER product type and serial number
- Date of purchase
- Name and address of the dealer from which you bought the BINDER product
- Exact description of the defect or fault
- Complete address; contact person and availability of that person
- Exact location of the BINDER product in your facility
- **The contamination clearance certificate (chap. 14) must be faxed in advance**

The authorization number must be applied to the packaging in such a way that it can be easily recognized or be recorded clearly in the delivery documents.



For security reasons we cannot accept a chamber delivery if it does not carry an authorization number.

**Return address:** BINDER GmbH      Gänsäcker 16  
Abteilung Service      78502 Tuttlingen, Germany

## 11. Disposal

### 11.1 Disposal of the transport packing

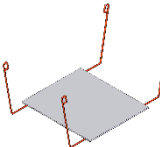
Packing element	Material	Disposal
Straps to fix packing on pallet	Plastic	Plastic recycling
Wooden transport box (option) with metal screws	Non-wood (compressed matchwood, IPPC standard)	Wood recycling
	Metal	Metal recycling
Pallet with foamed plastic stuffing	Solid wood (IPPC standard)	Wood recycling
	Plastic	Plastic recycling
Transport box with metal clamps	Cardboard	Paper recycling
	Metal	Metal recycling
Removal aid 	Cardboard	Paper recycling
	Plastic	Plastic recycling
Edge protection	Styropor® or PE foam	Plastic recycling
Protection of doors and racks	PE foam	Plastic recycling
Bag for operating manual	PE foil	Plastic recycling
Insulating air cushion foil (packing of optional accessories)	PE foil	Plastic recycling

If recycling is not possible, all packing parts can also be disposed of with normal waste.



## 11.2 Decommissioning

Disconnect the chamber from the power supply.

- Temporal decommissioning: See indications for appropriate storage, chap. 3.3.
- Final decommissioning: Dispose of the chamber as described in chap. 11.3 to 11.5.

## 11.3 Disposal of the chamber in the Federal Republic of Germany

According to Annex I of Directive 2012/19/EU of the European Parliament and of the Council on waste electrical and electronic equipment (WEEE), BINDER devices are classified as “monitoring and control instruments” (category 9) only intended for professional use“. They must not be disposed of at public collecting points.

The chambers bear the symbol for the marking of electrical and electronic equipment manufactured / placed on the market in the EC after 13 August 2005 and be disposed of in separate collection according to Directive 2012/19/EU on waste electrical and electronic equipment (WEEE) and German national law for electrical and electronic equipment (Elektro- und Elektronikgerätegesetz, ElektroG). WEEE marking: crossed-out wheeled bin with solid bar under. A significant part of the materials must be recycled in order to protect the environment.

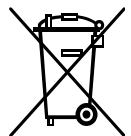



At the end of the device’s service life, have the device disposed of according to the German national law for electrical and electronic equipment (Elektro- und Elektronikgerätegesetz, ElektroG from 20 October 2015, BGBl. I p. 1739) or contact BINDER service who will organize taking back and disposal of the chamber according to the German national law for electrical and electronic equipment (Elektro- und Elektronikgerätegesetz, ElektroG from 20 October 2015, BGBl. I p. 1739).

<b>NOTICE</b>	
	<p><b>Danger of violation against existing law if not disposed of properly.</b></p> <p><b>Failure to comply with applicable law.</b></p> <ul style="list-style-type: none"> <li>⊘ Do NOT dispose of BINDER devices at public collecting points.</li> <li>➤ Have the device disposed of professionally at a recycling company which is certified according to the German national law for electrical and electronic equipment (Elektro- und Elektronikgerätegesetz, ElektroG from 20 October 2015, BGBl. I p. 1739).</li> <li style="text-align: center;"><i>or</i></li> <li>➤ Instruct BINDER Service to dispose of the device. The general terms of payment and delivery of BINDER GmbH apply, which were valid at the time of purchasing the chamber.</li> </ul>

Certified companies disassemble waste (used) BINDER equipment in primary substances for recycling according to Directive 2012/19/EU. The devices must be free from toxic, infectious or radioactive substances in order to eliminate any health hazards to the employees of the recycling companies.

	<p>Prior to handing the chamber over to a recycling company, it is the user’s responsibility that it is free from toxic, infectious or radioactive substances.</p> <ul style="list-style-type: none"> <li>• Prior to disposal, clean all introduced or residual toxic substances from the chamber.</li> <li>• Prior to disposal, disinfect the chamber from all sources of infection. Be aware that sources of infection may also be located outside the inner chamber.</li> <li>• If you cannot safely remove all toxic substances and sources of infection from the chamber, dispose of it as special waste according to national law.</li> <li>• Fill out the contamination clearance certificate (chap. 14) and enclose it with the chamber.</li> </ul>
---	---

	WARNING
  	<p><b>Danger of intoxication and infection through contamination of the chamber with toxic, infectious or radioactive substances.</b></p> <p><b>Damages to health.</b></p> <ul style="list-style-type: none"> <li>Ø NEVER take a chamber contaminated with toxic substances or sources of infection for recycling according to Directive 2012/19/EU.</li> <li>➤ Prior to disposal, remove all toxic substances and sources of infection from the chamber.</li> <li>➤ A chamber from which all toxic substances or sources of infection cannot be safely removed must be considered as “special” waste according to national law. Dispose of it accordingly.</li> </ul>

### 11.4 Disposal of the chamber in the member states of the EU except for the Federal Republic of Germany

According to Annex I of Directive 2012/19/EU of the European Parliament and of the Council on waste electrical and electronic equipment (WEEE), BINDER devices are classified as “monitoring and control instruments” (category 9) only intended for professional use“. They must not be disposed of at public collecting points.

The chambers bear the symbol for the marking of electrical and electronic equipment manufactured / placed on the market in the EC after 13 August 2005 and be disposed of in separate collection according to the Directive 2012/19/EU on waste electrical and electronic equipment (WEEE). WEEE marking: crossed-out wheeled bin with solid bar under.

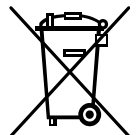





At the end of the device’s service life, notify the distributor who sold you the device, who will take back and dispose of the chamber according to the Directive 2012/19/EU on waste electrical and electronic equipment (WEEE).





	NOTICE
	<p><b>Danger of violation against existing law if not disposed of properly.</b></p> <p><b>Failure to comply with applicable law.</b></p> <ul style="list-style-type: none"> <li>Ø Do NOT dispose of BINDER devices at public collecting points.</li> <li>➤ Have the device disposed of professionally at a recycling company, which is certified according to conversion of the Directive 2012/19/EU into national law.</li> <li style="padding-left: 20px;"><i>or</i></li> <li>➤ Instruct the distributor who sold you the device to dispose of it. The agreements apply that were agreed with the distributor when purchasing the chamber (e.g. his general terms of payment and delivery).</li> <li>➤ If your distributor is not able to take back and dispose of the chamber, please contact BINDER service.</li> </ul>

Certified companies disassemble waste (used) BINDER equipment in primary substances for recycling according to Directive 2012/19/EU. The devices must be free from toxic, infectious or radioactive substances in order to eliminate any health hazards to the employees of the recycling companies.

	<p>Prior to handing the chamber over to a recycling company, it is the user's responsibility that it is free from toxic, infectious or radioactive substances.</p> <ul style="list-style-type: none"> <li>• Prior to disposal, clean all introduced or residual toxic substances from the chamber.</li> <li>• Prior to disposal, disinfect the chamber from all sources of infection. Be aware that sources of infection may also be located outside the inner chamber.</li> <li>• If you cannot safely remove all sources of infection and toxic substances from the chamber, dispose of it as special waste according to national law.</li> <li>• Fill out the contamination clearance certificate (chap. 14) and enclose it with the chamber.</li> </ul>
---	---

	<p style="text-align: center;"> <b>WARNING</b></p>
	<p><b>Danger of intoxication and infection through contamination of the chamber with toxic, infectious or radioactive substances.</b></p> <p><b>Damages to health.</b></p> <ul style="list-style-type: none"> <li>Ø NEVER take a chamber contaminated with toxic substances or sources of infection for recycling according to Directive 2012/19/EU.</li> <li>➤ Prior to disposal, remove all toxic substances and sources of infection from the chamber.</li> <li>➤ A chamber from which all toxic substances or sources of infection cannot be safely removed must be considered as "special" waste according to national law. Dispose of it accordingly.</li> </ul>
	

## 11.5 Disposal of the chamber in non-member states of the EU

	<p style="text-align: center;"><b>NOTICE</b></p>
	<p><b>Danger of violation against existing law if not disposed of properly.</b></p> <p><b>Failure to comply with applicable law. Alteration of the environment.</b></p> <ul style="list-style-type: none"> <li>➤ For final decommissioning and disposal of the chamber, please contact BINDER service.</li> <li>➤ Follow the statutory regulations for appropriate, environmentally friendly disposal.</li> </ul>

## 12. Technical description

### 12.1 Factory calibration and adjustment

This chamber was calibrated and adjusted in the factory. Calibration and adjustment were performed using standardized test instructions, according to the QM DIN EN ISO 9001 system applied by BINDER (certified since December 1996 by TÜV CERT). All test equipment used is subject to the administration of measurement and test equipment that is also constituent part of the BINDER QM DIN EN ISO 9001 systems. They are controlled and calibrated to a DKD-Standard at regular intervals.

	<p>Repeated calibrations are recommended in periods of 12 months.</p>
---	---

## 12.2 Definition of usable volume

The usable volume illustrated below is calculated as follows:

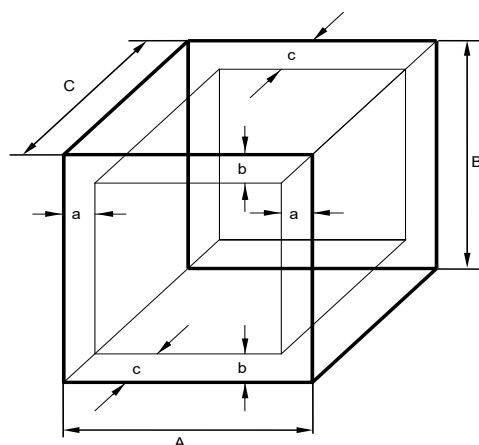

A, B, C = Internal dimensions (W, H, D)  
a, b, c = Wall clearances

$$a = 0.1 \times A$$

$$b = 0.1 \times B$$

$$c = 0.1 \times C$$

$$V_{USE} = (A - 2a) \times (B - 2b) \times (C - 2c)$$

Figure 9: Determination of the usable volume

The technical data refers to the defined usable volume.



Do NOT place samples outside this usable volume.

Do NOT load this volume by more than half to enable sufficient airflow inside the chamber.

Do NOT divide the usable volume into separate parts with large area samples.

Do NOT place samples too close to each other in order to permit circulation between them and thus obtain a homogenous distribution of temperature.

## 12.3 Over current protection

The chambers are protected by a miniature fuse against over current, accessible from the outside. The miniature fuse is located at the rear of the chamber below the strain relief of the power cord. The fuse holder is equipped with a fuse clip 5mm x 20 mm. (cUL-Version 6,3x32 mm). The fuse may be replaced only with a substitute of the same ratings. Refer to the technical data of the respective device type.

## 12.4 Technical data, BF / BF-UL 400

Exterior dimensions		
Width, net	mm / inch	1234 / 48.58
Height, gross (incl. feet/castors)	mm / inch	1022 / 40.24
Depth	mm / inch	765 / 30.12
Depth, gross (plus door handle, and exhaust duct)	mm / inch	870 / 34.25
Wall clearance rear (minimum)	mm / inch	100 / 3.94
Wall clearance side (minimum)	mm / inch	160 / 6.30
Exhaust duct, outer diameter	mm / inch	52 / 2.05
Doors		
Number of doors		2
Number of inner glass doors		2
Interior dimensions		
Width	mm / inch	1000 / 39.37
Height	mm / inch	800 / 31.50
Depth	mm / inch	500 / 19.69
Interior volume	l / cu.ft.	400 / 14.3
Steam space volume	l / cu.ft.	457 / 16.15

<b>Racks</b>			
Quantity of racks (regular)			2
Quantity of racks (max.)			9
Maximum load per rack		Kg / lbs	35 / 77
Permitted total load		Kg / lbs	90 / 199
<b>Weight</b>			
Weight (empty)		Kg / lbs	145 / 320
<b>Temperature data</b>			
Temperature range, 5 °C / 9 °F above ambient up to		°C / °F	100 / 212
Temperature fluctuation	at 37 °C / 98.6 °F	± K	0.1
	at 50 °C / 122 °F	± K	0.2
Temperature uniformity (variation)	at 37 °C / 98.6 °F	± K	0.4
	at 50 °C / 122 °F	± K	0.8
Heating up time	to 37 °C / 98.6 °F	minutes	12
	to 50 °C / 122 °F	minutes	23
Recovery time after door was opened for 30 sec	at 37 °C / 98.6 °F	minutes	5
	at 50 °C / 122 °F	minutes	4
Air change	at 50 °C / 122 °F	x/h	17
<b>Electrical data (model version BF400-230V)</b>			
IP system of protection acc. to EN 60529			20
Nominal voltage (+/-10 %)	at 50 Hz power frequency	V	230
	at 60 Hz power frequency	V	230
Current type			1N~
Nominal power			kW
Chamber fuse 5 x 20 mm			A
230V / 10A / middle-time-lag (M)			external
Power plug			Grounded plug
Installation category acc. to IEC 61010-1			II
Pollution degree acc. to IEC 61010-1			2
<b>Different electrical data for BF-UL constructed for the USA and Canada (model version BF400UL-120V)</b>			
Nominal voltage (+/-10 %) at 60 Hz power frequency		V	115
Current type			1N~
Power plug			NEMA
5-15P			
Nominal power			kW
Chamber fuse 6,3 x 32 mm			A
250V / super-time-lag TT			external
Additional temperature protection class 1 (DIN 12880:2007)			internal
<b>Environment-specific data</b>			
Noise level (mean value)		dB (A)	< 55
Energy consumption at 37 °C / 98.6 °F		Wh/h	53

All technical data is specified for unloaded chambers with standard equipment at an ambient temperature of +22 °C +/- 3 °C / 71.6 °F +/- 5.4 °F and a power supply voltage fluctuation of +/-10. Technical data is determined in accordance to BINDER Factory Standard Part 1:2015 following DIN 12880:2007.

**All indications are average values, typical for chambers produced in series. We reserve the right to change technical specifications at any time.**



If the chamber is fully loaded, the specified heating up times may vary according to the load.

## 12.5 Equipment and options (extract)



To operate chamber, use only original BINDER accessories or accessories / components from third-party suppliers authorized by BINDER. The user is responsible for any risk arising from using unauthorized accessories.

<b>Standard equipment</b>
Microprocessor temperature controller with LED display and several time functions
Three Timer functions: Delayed On, Delayed Off and temperature dependent delayed Off
Temperature safety device class 3.1 acc. to DIN 12880:2007 with visual temperature alarm
Adjustable ramp function
Rear exhaust duct, internal diameter 50 mm / 1.97 in with ventilation slide
Adjustable air change by rear exhaust duct (50 mm / 1.97 in ) with ventilat.flap and front ventilation slide
RS 422 interface for APT-COM™ 4 Multi Management Software, or switch over to printer output with RS 232/RS 422 interface converter
Access ports with various diameters, with silicone plug

<b>Options / accessories</b>
Rack, chrome-plated or stainless steel
Perforated rack, stainless steel
Lockable door
Additional Pt100 temperature sensor, fix or flexible, with external connection including LEMO plug (3 pins)
Analog output 4-20 mA for temperature with 6 pole DIN socket, DIN plug included
Disconnectable audible over-temperature alarm
Chamber acc. to cUL standard in 115V 1N~ 60Hz
Calibration of temperature including certificate
Spatial temperature measurements including certificate
Spatial temperature measurement acc. to DIN 12880 including certificate
Qualification folder
Neutral cleaning agent (liquid concentrate)
Stable table on wheels with castors and locking brakes

## 12.6 Accessories and spare parts (extract)



BINDER GmbH is responsible for the safety features of the chamber only, provided skilled electricians or qualified personnel authorized by BINDER perform all maintenance and repair, and if components relating to chamber safety are replaced in the event of failure with original spare parts. The user is responsible for any risks arising from using unauthorized accessories/components.

Description	Art. No.
Rack, chrome-plated	6004-0005
Rack, stainless steel	6004-0011
Perforated rack, stainless steel	6004-0032
Door gasket silicone	6005-0069
Stable table on wheels with castors and locking brakes	9051-0019
Chamber fuse 5x20mm 250V 10A semi time lag (M)	5006-0012
Neutral cleaning agent, 1 kg	1002-0016

Validation service	Art. no.
Qualification folder IQ-OQ (printed version)	7007-0001
Qualification folder IQ-OQ (digital version)	7057-0001
Qualification folder IQ-OQ-PQ (printed version)	7007-0005
Qualification folder IQ-OQ-PQ (digital version)	7057-0005
Execution of IQ-OQ	DL400100
Execution of IQ-OQ-PQ	DL440500

Calibration service	Art. No.
Calibration of temperature including certificate (1 measuring point)	DL300101
Spatial temperature measurement including certificate (9 measuring points)	DL300109
Spatial temperature measurement including certificate (18 measuring points)	DL300118
Spatial temperature measurement including certificate (27 measuring points)	DL300127

For information on components not listed here, please contact BINDER Service.

## 13. Certificates and declarations of conformity

### 13.1 EU Declaration of Conformity

**CE** EU-Konformitätserklärung / EU Declaration of Conformity / Déclaration de conformité UE / Declaración de conformidad UE / Dichiarazione di conformità UE / Декларация соответствия EU

Hersteller / Manufacturer / Fabricant / Fabricante / Fabbricante / Производитель	BINDER GmbH
Anschrift / Address / Adresse / Dirección / In- dirizzo / Адрес	Im Mittleren Ösch 5, 78532 Tuttlingen, Germany
Produkt / Product / Produit / Producto / Prodotto / Продукт	Inkubatoren mit Umluft Incubators with forced convection Incubateurs à convection forcée Incubadoras de convección forzada Incubatori a convezione forzata Инкубаторы с принудительной циркуляцией воздуха
Typenbezeichnung / Type / Type / Tipo / Tipo / Тип	BF 400 (E1)
Art. No. / Art. no. / Réf. / Art. N° / Art. n. / № apr.	9010-0241, 9110-0241, 9010-0242, 9110-0242

Die oben beschriebenen Produkte sind konform mit folgenden EG/EU-Richtlinien:

The products described above are in conformity with the following EC/EU Directives:

Les produits décrits ci-dessus sont conformes aux directives CE/UE suivantes:

Los productos descritos arriba cumplen con las siguientes directivas de la CE/UE:

I prodotti sopra descritti sono conformi alle seguenti direttive CE/UE:

Продукты, указанные выше, полностью соответствуют следующим ЕС/ЕУ руководствам:

- **2006/42/EC**  
Maschinenrichtlinie 2006/42/EG / Machinery directive 2006/42/EC / Directive Machines 2006/42/EC / Directiva 2006/42/CE (Máquinas) / Direttiva macchine 2006/42/CE / Директива о машинах 2006/42/EC
- **2014/30/EU**  
EMV-Richtlinie 2014/30/EU / EMC Directive 2014/30/EU / Directive CEM 2014/30/UE / Directiva CEM 2014/30/UE / Direttiva EMC 2014/30/UE / Директива ЭМС 2014/30/EU
- **2011/65/EU, (EU) 2015/863**  
RoHS-Richtlinien 2011/65/EU und (EU) 2015/863 / RoHS Directives 2011/65/EU and (EU) 2015/863 / Directives RoHS 2011/65/UE et (UE) 2015/863 / Directivas RoHS 2011/65/UE y (UE) 2015/863 / Direttive RoHS 2011/65/UE et (UE) 2015/863 / Директивы RoHS 2011/65/EU и (EU) 2015/863

1 / 2



Die oben beschriebenen Produkte tragen entsprechend die Kennzeichnung CE.  
The products described above, corresponding to this, bear the CE-mark.  
Les produits décrits ci-dessus, en correspondance, portent l'indication CE.  
Los productos descritos arriba, en conformidad, llevan la indicación CE.  
I prodotti sopra descritti, conformi a quanto sopra, portano il marchio CE.  
Данные продукты в соответствии с изложенным выше маркированы знаком CE.

Die oben beschriebenen Produkte sind konform mit folgenden harmonisierten Normen:  
The products described above are in conformity with the following harmonized standards:  
Les produits décrits ci-dessus sont conformes aux normes harmonisées suivantes:  
Los productos descritos arriba cumplen con las siguientes normas:  
I prodotti sopra descritti sono conformi alle seguenti normative armonizzate:  
Продукты, указанные выше, полностью соответствуют следующим стандартам:

Sicherheit / Safety / Sécurité / Seguridad / Sicurezza / Нормативы по безопасности
<ul style="list-style-type: none"><li>• EN ISO 12100:2010 + Corr. 1:2011</li><li>• EN ISO 13732-1:2008</li><li>• EN 60204-1:2018</li></ul>
EMV / EMC / CEM / CEM / EMC / ЭМС
<ul style="list-style-type: none"><li>• EN 61326-1:2013</li></ul>
RoHS
<ul style="list-style-type: none"><li>• EN IEC 63000:2018</li></ul>

78532 Tuttlingen, 28.01.2022

BINDER GmbH



P. Wimmer  
Vice President  
Vice President  
Vice président  
Vicepresidente  
vicepresidente  
Вице-президент



J. Bollaender  
Leiter F & E  
Director R & D  
Chef de service R&D  
Responsable I & D  
Direttore R & D  
Глава департамента R&D

2 / 2

BINDER GmbH Postfach 102 D-78502 Tuttlingen Anschrift: BINDER GmbH Im Mittleren Ösch 5 D-78532 Tuttlingen  
Kontakt: Telefon: +49 (0) 74 62 / 20 05 – 0 | Telefax: +49 (0) 74 62 / 20 05 – 100 | info@binder-world.com | www.binder-world.com  
Geschäftsführung: Dipl.-Ing. Peter M. Binder | Amtsgericht Stuttgart, HRB 727150 | Sitz der Gesellschaft: Tuttlingen  
Bankverbindung: Kreissparkasse Tuttlingen IBAN-Code: DE05643 500700 000002266 | SWIFT-Code: SOLA DE 51TUT  
Deutsche Bank Tuttlingen IBAN-Code: DE56653 70075 0213870900 | SWIFT-Code: DEUT DE 55653  
Altgeräte-Entsorgung gemäß WEEE-Reg.-Nr. DE 37004983

## 13.2 UKCA Declaration of Conformity



	<h3>UKCA Declaration of Conformity</h3>
---	---

Name and address of manufacturer	BINDER GmbH Im Mittleren Ösch 5, 78532 Tuttlingen, Germany
Name and address of UK Authorised Representative	Comply Express Ltd Unit C2, Coalport House, Stafford Park 1, Telford TF3 3BD
Object of the Declaration	Incubators with forced convection
Type Designation	BF 400 (E1)
BINDER Art. No.	9010-0241, 9110-0241



The Objects of the Declaration described above are in conformity with the relevant UK Regulations and UK Guidelines:

- **Supply of Machinery (Safety) Regulations 2008**  
Statutory Instruments 2008 No. 1597 – Health and safety
- **Electromagnetic Compatibility Regulations 2016**  
Statutory Instruments 2016 No. 1091 – Electromagnetic Compatibility
- **The Restriction of the Use of Certain Hazardous Substances in Electrical and Electronic Equipment Regulations 2012**  
Statutory Instruments 2012 No. 3032 – Environmental Protection

References of standards and/or technical specifications applied for this Declaration of Conformity, or parts thereof:

<b>S.I. 2008 No. 1597:</b>	EN ISO 12100:2010 EN ISO 13732-1:2008 EN 60204-1:2018
<b>S.I. 2016 No. 1091:</b>	EN 61326-1:2013
<b>S.I. 2012 No. 3032:</b>	EN IEC 63000:2018

This Declaration is issued under the sole responsibility of the manufacturer.

Tuttlingen	27.06.2022	 P. Wimmer Vice President	 J. Bollaender Director R & D	BINDER GmbH
Place	Date			

BINDER GmbH  
Im Mittleren Ösch 5  
78502 Tuttlingen  
Deutschland

Tel: +49 (0) 74 62 / 20 05 - 0  
Fax: +49 (0) 74 62 / 20 05 - 100  
info@binder-world.com  
www.binder-world.com

Geschäftsführung:  
Dipl.-Ing. Peter M. Binder  
Amtsgericht Stuttgart, HRB 727150  
Sitz der Gesellschaft: Tuttlingen  
Ust.-ID.-Nr.: DE815021304

Kreissparkasse Tuttlingen  
IBAN: DE05 6435 0070 0000 0022 66  
SWIFT: SOLA DE 31TUT  
Deutsche Bank Tuttlingen  
IBAN: DE56 6537 0075 0213 8709 00  
SWIFT: DEUT DE 33653

### 13.3 Certificate for the GS mark of conformity of the “Deutsche Gesetzliche Unfallversicherung e.V.“ (German Social Accident Insurance) DGUV

Zertifikat  
Nr. **NV 18098**  
vom 29.05.2018



## GS-Zertifikat

Name und Anschrift des  
Zertifikatsinhabers:  
(Auftraggeber)

**Binder GmbH**  
Im Mittleren Ösch 5  
78532 Tuttlingen

Produktbezeichnung:

**Klimaschränke Inkubatoren, Trocken- und Wärmeschränke**

Typ:

BD 23, BD 400, BD 720, BF 400, BF 720, ED 23, ED 400, ED 720,  
FD 23, FED 400, FED 720

Prüfgrundlage:

GS-NV 2:2017/09 Prüfgrundsätze für Nahrungsmittelmaschinen

Zugehöriger Prüfbericht:

Prüfbericht zum Zertifikat NV 18098

Weitere Angaben:

Das Zertifikat bezieht sich auf die im zugehörigen Prüfbericht beschriebene Ausführung des Produkts.

Das geprüfte Baumuster stimmt mit den in § 21 Absatz 1 des Produktsicherheitsgesetzes genannten Anforderungen überein. Der Zertifikatsinhaber ist berechtigt, das umseitig abgebildete GS-Zeichen an den mit dem geprüften Baumuster übereinstimmenden Produkten anzubringen. Der Zertifikatsinhaber hat dabei die umseitig aufgeführten Bedingungen zu beachten.

Dieses Zertifikat einschließlich der Berechtigung zur Anbringung des GS-Zeichens ist gültig bis einschließlich:

**28.05.2023**

Weiteres über die Gültigkeit, eine Gültigkeitsverlängerung und andere Bedingungen regelt die Prüf- und Zertifizierungsordnung.



PZB04\_D  
09.16

Deutsche Gesetzliche Unfallversicherung (DGUV) e.V.  
Spitzenverband der gewerblichen Berufsgenossenschaften  
und der Unfallversicherungsträger der öffentlichen Hand  
Vereinsregister-Nr. VR 751 B, Amtsgericht Charlottenburg

DGUV Test Prüf- und Zertifizierungsstelle Nahrungsmittel und Verpackung  
Fachbereich Nahrungsmittel  
Dynamostraße 7-11 • 68165 Mannheim • Deutschland  
Telefon: +49 (0) 6 21 44 56-34 30 • Fax: +49 (0) 800 1977 553 16625

Rückseite GS-Zertifikat: NV 18098

## GS-Zeichen



Normalausführung



Bei einer Höhe von 20 mm oder weniger  
auch zulässige Ausführung

1. Der Zertifikatsinhaber hat die Voraussetzungen einzuhalten, die bei der Herstellung des umseitig genannten Produktes zu beachten sind, um die Übereinstimmung mit dem geprüften Baumuster zu gewährleisten.
2. Die Prüf- und Zertifizierungsstelle des Fachbereichs Nahrungsmittel führt in regelmäßigen Abständen Kontrollmaßnahmen zur Überwachung der Herstellung und rechtmäßigen Verwendung des GS-Zeichens durch.
3. Die für die Herstellung verantwortliche Person hat sich zur Einhaltung der Voraussetzungen nach Nummer 1 und Duldung der Kontrollmaßnahmen verpflichtet.
4. Die Prüf- und Zertifizierungsstelle entzieht dem Zertifikatsinhaber die Zuerkennung des GS-Zeichens, wenn sich die Anforderungen nach § 21 Absatz 1 Produktsicherheitsgesetz geändert haben oder die Voraussetzungen nach Nummer 1 nicht eingehalten werden.
5. Das GS-Zeichen darf nur verwendet und mit ihm darf nur geworben werden, wenn die Voraussetzungen nach § 22 Produktsicherheitsgesetz erfüllt sind.

## 14. Contamination clearance certificate

Unbedenklichkeitsbescheinigung

### 14.1 For chambers located outside the USA and Canada

#### Declaration of harmlessness with regard to safety and health

Erklärung zur Sicherheit und gesundheitlichen Unbedenklichkeit

The German Ordinance on Hazardous Substances (GefStofV), and the regulations regarding safety at the workplace, require that this form be filled out for all products that are returned to us, so that the safety and health of our employees can be warranted.

Die Sicherheit und Gesundheit unserer Mitarbeiter, die Gefahrstoffverordnung GefStofV und die Vorschriften zur Sicherheit am Arbeitsplatz machen es erforderlich, dass dieses Formblatt für alle Produkte, die an uns zurückgeschickt wird.



In the absence of a completely filled out form, a repair is not possible.  
Ohne Vorliegen des vollständig ausgefüllten Formblattes ist eine Reparatur nicht möglich.

- A completely filled out form should be transmitted by Fax (+49 (0) 7462 2005 93555) or by letter in advance to us, so that this information is available before the equipment/component part arrives. A second copy of this form should accompany the equipment/component part. Eventually the carrier should be informed.

Eine vollständig ausgefüllte Kopie dieses Formblattes soll per Telefax (Nr. +49 (0) 7462 2005 93555) oder Brief vorab an uns gesandt werden, so dass die Information vorliegt, bevor das Gerät/Bauteil eintrifft. Eine weitere Kopie soll dem Gerät/Bauteil beigelegt sein. Ggf. ist auch die Spedition zu informieren.

- Incomplete information or non-conformity with this procedure will inevitably lead to substantial delays in processing. We hope you will have understanding for this measure, which lies outside of our area of influence, and that you will help us to speed up this procedure.

Unvollständige Angaben oder Nichteinhalten dieses Ablaufs führen zwangsläufig zu beträchtlichen Verzögerungen in der Abwicklung. Bitte haben Sie Verständnis für Maßnahmen, die außerhalb unserer Einflussmöglichkeiten liegen und helfen Sie mit, den Ablauf beschleunigen.

- **Please fill out this form completely.**

Bitte unbedingt vollständig ausfüllen!

<b>1.</b>	<b>Unit/ component part / type: / Gerät / Bauteil / Typ:</b>
<b>2.</b>	<b>Serial No./ Serien-Nr.:</b>
<b>3.</b>	<b>Details about utilized substances / biological substances / Einzelheiten über die eingesetzten Substanzen/biologische Materialien:</b>
<b>3.1</b>	<b>Designations / Bezeichnungen:</b>
a)	_____
b)	_____
c)	_____
<b>3.2</b>	<b>Safety measures required for handling these substances / Vorsichtsmaßnahmen beim Umgang mit diesen Stoffen:</b>
a)	_____
b)	_____
c)	_____

<b>3.3 Measures to be taken in case of skin contact or release into the atmosphere / Maßnahmen bei Personenkontakt oder Freisetzung:</b>
a) _____
b) _____
c) _____
d) _____
<b>3.4 Other important information that must be taken into account / Weitere zu beachtende und wichtige Informationen:</b>
a) _____
b) _____
c) _____
<b>4. Declaration on the risk of these substances (please checkmark the applicable items) / Erklärung zur Gefährlichkeit der Stoffe (bitte Zutreffendes ankreuzen) :</b>
<input type="checkbox"/> <b>4.1 For non toxic, non radioactive, biologically harmless materials / für nicht giftige, nicht radioaktive, biologisch ungefährliche Stoffe:</b>
<b>We herewith guarantee that the above-mentioned unit / component part... / Wir versichern, dass o.g. Gerät/Bauteil...</b>
<input type="checkbox"/> Has not been exposed to or contains any toxic or otherwise hazardous substances / weder giftige noch sonstige gefährliche Stoffe enthält oder solche anhaften.
<input type="checkbox"/> That eventually generated reaction products are non-toxic and also do not represent a hazard / auch evtl. entstandene Reaktionsprodukte weder giftig sind noch sonst eine Gefährdung darstellen.
<input type="checkbox"/> Eventual residues of hazardous substances have been removed / evtl. Rückstände von Gefahrstoffen entfernt wurden.
<input type="checkbox"/> <b>4.2 For toxic, radioactive, biologically harmful or hazardous substances, or any other hazardous materials / für giftige, radioaktive, biologisch bedenkliche bzw. gefährliche Stoffe oder anderweitig gefährliche Stoffe.</b>
<b>We herewith guarantee that ... / Wir versichern, dass ...</b>
<input type="checkbox"/> The hazardous substances, which have come into contact with the above-mentioned equipment/component part, have been completely listed under item 3.1 and that all information in this regard is complete / die gefährlichen Stoffe, die mit dem o.g. Gerät/Bauteil in Kontakt kamen, in 3.1 aufgelistet sind und alle Angaben vollständig sind.
<input type="checkbox"/> That the unit /component part has not been in contact with radioactivity / das Gerät/Bauteil nicht mit Radioaktivität in Berührung kam
<b>5. Kind of transport / transporter / Transportweg/Spediteur:</b>
Transport by (means and name of transport company, etc.) Versendung durch (Name Spediteur o.ä.)
_____
Date of dispatch to BINDER GmbH / Tag der Absendung an BINDER GmbH:
_____

**We herewith declare that the following measures have been taken / Wir erklären, dass folgende Maßnahmen getroffen wurden:**

- Hazardous substances were removed from the unit / component part, so that no hazard exists for corresponding persons in the handling or repair of these items / das Gerät/Bauteil wurde von Gefahrstoffen befreit, so dass bei Handhabung/Reparaturen für die betreffenden Person keinerlei Gefährdung besteht
- The unit was securely packaged and properly identified / das Gerät wurde sicher verpackt und vollständig gekennzeichnet.
- Information about the hazardousness of the shipment (if required) has been provided to the transporter / der Spediteur wurde (falls vorgeschrieben) über die Gefährlichkeit der Sendung informiert.

We herewith commit ourselves and guarantee that we will indemnify BINDER GmbH for all damages that are a consequence of incomplete or incorrect information provided by us, and that we will exempt BINDER GmbH from eventual damage claims by third parties. / Wir versichern, dass wir gegenüber BINDER für jeden Schaden, der durch unvollständige und unrichtige Angaben entsteht, haften und BINDER gegen eventuell entstehende Schadenersprüche Dritter freistellen.

We are aware that, in accordance with Article 823 of the German Civil Code (BGB), we are directly liable with regard to third parties, in this instance especially the employees of BINDER GmbH, who have been entrusted with the handling / repair of the unit / component. / Es ist uns bekannt, dass wir gegenüber Dritten – hier insbesondere mit der Handhabung/Reparatur des Geräts/des Bauteils betraute Mitarbeiter der Firma BINDER – gemäß §823 BGB direkt haften

Name: \_\_\_\_\_

Position: \_\_\_\_\_

Date / Datum: \_\_\_\_\_

Signature / Unterschrift: \_\_\_\_\_

Company stamp / Firmenstempel:



Equipment that is returned to the factory for repair must be accompanied by a completely filled out contamination clearance certificate. For service and maintenance works on site, such a contamination clearance certificate must be submitted to the service technician before the start of the works. No repair or maintenance of the equipment is possible, without a properly filled out contamination clearance certificate.

## 14.2 For chambers located in the USA and Canada

### Product Return Authorization Request

Please complete this form and the Customer Decontamination Declaration (next 2 pages) and attach the required pictures. E-mail to: IDL\_SalesOrderProcessing\_USA@binder-world.com

After we have received and reviewed the complete information we will decide on the issue of a RMA number. Please be aware that size specifications, voltage specifications as well as performance specifications are available on the internet at [www.binder-world.us](http://www.binder-world.us) at any time.

Take notice of shipping laws and regulations.

	Please fill:	
Reason for return request	<input type="radio"/> Duplicate order	
	<input type="radio"/> Duplicate shipment	
	<input type="radio"/> Demo	<i>Page one completed by sales</i>
	<input type="radio"/> Power Plug / Voltage	115V / 230 V / 208 V / 240V
	<input type="radio"/> Size does not fit space	
	<input type="radio"/> Transport Damage	Shock watch tripped? ( <i>pictures</i> )
	<input type="radio"/> Other (specify below)	
	_____	
Is there a replacement PO?	<input type="radio"/> Yes <input type="radio"/> No	
<i>If yes -&gt; PO #</i>		
<i>If yes -&gt; Date PO placed</i>		
Purchase order number		
BINDER model number		
BINDER serial number		
Date unit was received		
Was the unit unboxed?	<input type="radio"/> Yes <input type="radio"/> No	
Was the unit plugged in?	<input type="radio"/> Yes <input type="radio"/> No	
Was the unit in operation?	<input type="radio"/> Yes <input type="radio"/> No	
<i>Pictures of unit attached?</i>	<input type="radio"/> Yes <input type="radio"/> No	Pictures have to be attached!
<i>Pictures of Packaging attached?</i>	<input type="radio"/> Yes <input type="radio"/> No	

	Customer Contact Information	Distributor Contact Information
Name		
Company		
Address		
Phone		
E-mail		



## Customer (End User) Decontamination Declaration

### Health and Hazard Safety declaration

To protect the health of our employees and the safety at the workplace, we require that this form is completed by the user for all products and parts that are returned to us. (Distributors or Service Organizations cannot sign this form)



NO RMA number will be issued without a completed form. Products or parts returned to our NY warehouse without a RMA number will be refused at the dock.

A second copy of the completed form must be attached to the outside of the shipping box.

<b>1. Unit/ component part / type:</b>
<b>2. Serial No.</b>
<b>3. List any exposure to hazardous liquids, gasses or substances and radioactive material</b>
<b>3.1 List with MSDS sheets attached where available or needed (if there is not enough space available below, please attach a page):</b>
a) _____
b) _____
c) _____
<b>3.2 Safety measures required for handling the list under 3.1</b>
a) _____
b) _____
c) _____
<b>3.3 Measures to be taken in case of skin contact or release into the atmosphere:</b>
a) _____
b) _____
c) _____
d) _____
<b>3.4 Other important information that must be considered:</b>
a) _____
b) _____
c) _____

**4. Declaration of Decontamination**

**For toxic, radioactive, biologically and chemically harmful or hazardous substances, or any other hazardous materials.**

**We hereby guarantee that**

- 4.1 Any hazardous substances, which have come into contact with the above-mentioned equipment / component part, have been completely listed under item 3.1 and that all information in this regard is complete.
- 4.2 That the unit /component part has not been in contact with radioactivity
- 4.3 Any Hazardous substances were removed from the unit / component part, so that no hazard exists for a persons in the shipping, handling or repair of these returned unit
- 4.4 The unit was securely packaged in the original undamaged packaging and properly identified on the outside of the packaging material with the unit designation, the RMA number and a copy of this declaration.
- 4.5 Shipping laws and regulations have not been violated.

**I hereby commit and guarantee that we will indemnify BINDER Inc. for all damages that are a consequence of incomplete or incorrect information provided by us, and that we will indemnify and hold harmless BINDER Inc. from eventual damage claims by third parties.**

Name: \_\_\_\_\_

Position: \_\_\_\_\_

Company: \_\_\_\_\_

Address: \_\_\_\_\_

Phone #: \_\_\_\_\_

Email: \_\_\_\_\_

Date: \_\_\_\_\_

Signature: \_\_\_\_\_



Equipment returned to the NY warehouse for repair must be accompanied by a completed customer decontamination declaration. For service and maintenance works on site, such a customer decontamination declaration must be submitted to the service technician before the start of work. No repair or maintenance of the equipment is possible without a completed form.

