

# Operating Manual

## CB / CB-UL, CBF / CBF-UL (E7)

### CO<sub>2</sub> Incubators

### CO<sub>2</sub> Incubators with O<sub>2</sub> Control

### CO<sub>2</sub> Incubators with Humidity control

with sterilizable NDIR sensor system for CO<sub>2</sub>  
 and microprocessor display program controller MB2 with touchscreen

Model	Model version	Voltage	Equipment	Art. no.
CB 56	CB56-230V	200-230 V		9640-0005
CB 56-UL	CB56-120V	100-120 V		9640-0007
CB 170	CB170-230V	200-230 V		9640-0009
CB 170	CB170-230V-D	200-230 V	Access port 30 mm, left	9640-0027
CB 170	CB170-230V-O	200-230 V	O <sub>2</sub> control 0-20 vol.-%	9640-0010
CB 170-UL	CB170-120V	100-120 V		9640-0011
CB 170-UL	CB170UL-120V-D	100-120 V	Access port 30 mm, left	9640-0028
CB 170-UL	CB170-120V-O	100-120 V	O <sub>2</sub> control 0-20 vol.-%	9640-0012
CB 260	CB260-230V	200-230 V		9640-0013
CB 260	CB260-230V-O	200-230 V	O <sub>2</sub> control 0-20 vol.-%	9640-0014
CB 260-UL	CB260-120V	100-120 V		9640-0015
CB 260-UL	CB260-120V-O	100-120 V	O <sub>2</sub> control 0-20 vol.-%	9640-0016

Model	Model version	Voltage	Equipment	Art. no.
CBF 170	CBF170-230V	200-230 V		9640-0017
CBF 170	CBF170-230V-O	200-230 V	O <sub>2</sub> control 0-20 vol.-%	9640-0018
CBF 170-UL	CBF170-120V	100-120 V		9640-0019
CBF 170-UL	CBF170-120V-O	100-120 V	O <sub>2</sub> control 0-20 vol.-%	9640-0020
CBF 260	CBF260-230V	200-230 V		9640-0021
CBF 260	CBF260-230V-O	200-230 V	O <sub>2</sub> control 0-20 vol.-%	9640-0022
CBF 260-UL	CBF260-120V	100-120 V		9640-0023
CBF 260-UL	CBF260-120V-O	100-120 V	O <sub>2</sub> control 0-20 vol.-%	9640-0024

#### BINDER GmbH

- ▶ Address: Post office box 102, 78502 Tuttlingen, Germany ▶ Phone: +49 7462 2005 0
- ▶ Fax: +49 7462 2005 100 ▶ Internet: <http://www.binder-world.com>
- ▶ Service Hotline: +49 7462 2005 555
- ▶ Service Fax: +49 7462 2005 93 555
- ▶ Service Hotline USA: +1 866 885 9794 or +1 631 224 4340 x3
- ▶ Service Hotline Asia Pacific: +852 390 705 04 or +852 390 705 03

---

## Contents

<b>1. SAFETY</b> .....	<b>8</b>
1.1 Personnel Qualification .....	8
1.2 Operating manual.....	8
1.3 Legal considerations .....	8
1.3.1 Intellectual property.....	9
1.4 Structure of the safety instructions.....	9
1.4.1 Signal word panel .....	9
1.4.2 Safety alert symbol .....	10
1.4.3 Pictograms .....	10
1.4.4 Word message panel structure .....	11
1.5 Localization / position of safety labels on the chamber .....	11
1.6 Type plate.....	12
1.7 UKCA Label .....	13
1.8 General safety instructions on installing and operating the CO <sub>2</sub> incubator.....	14
1.9 Precautions when working with gases .....	16
1.10 Precautions when handling gas cylinders.....	17
1.11 Intended use .....	18
1.12 Foreseeable Misuse .....	20
1.13 Residual Risks .....	20
1.14 Operating instructions .....	22
1.15 Measures to prevent accidents .....	22
1.16 CBF / CBF-UL : Resistance of the humidity sensor against harmful substances.....	23
<b>2. CHAMBER DESCRIPTION</b> .....	<b>24</b>
2.1 Chamber overview .....	25
2.2 CB / CB UL inner chamber.....	26
2.3 CBF / CBF UL inner chamber .....	27
2.4 Control panel on the rear of the chamber .....	28
2.5 Instrument panel .....	29
<b>3. COMPLETENESS OF DELIVERY, TRANSPORTATION, STORAGE, AND INSTALLATION</b> .....	<b>29</b>
3.1 Unpacking, and checking equipment and completeness of delivery .....	29
3.2 Guidelines for safe lifting and transportation.....	30
3.3 Storage.....	30
3.4 Location of installation and ambient conditions .....	31
<b>4. INSTALLATION AND CONNECTIONS</b> .....	<b>34</b>
4.1 Shelves.....	34
4.2 Permady™ water pan (CB / CB-UL).....	35
4.3 Connecting the O <sub>2</sub> sensor (chamber with O <sub>2</sub> control).....	36
4.4 Gas connections .....	36
4.4.1 Connection of the CO <sub>2</sub> gas cylinder.....	37
4.4.2 Connection of the O <sub>2</sub> gas cylinder (chamber with O <sub>2</sub> control with optional alternative control range 10 up to 90 vol.-% O <sub>2</sub> ) .....	38
4.4.3 Connection of the N <sub>2</sub> gas cylinder (chamber with O <sub>2</sub> control).....	39
4.4.4 Connecting the gas hose to the chamber rear (for CO <sub>2</sub> , O <sub>2</sub> , N <sub>2</sub> ) .....	40
4.4.5 Gas cylinder connection kits (option).....	42
4.5 CBF / CBF-UL: Water supply and dehumidification.....	42
4.5.1 General remarks on water supply.....	42
4.5.1.1 Water supply.....	42
4.5.1.2 Dehumidification .....	43
4.5.1.3 Types of suitable water quality .....	43
4.5.1.4 BINDER Pure Aqua Service (option).....	43

4.5.2	Water supply via freshwater bag (standard).....	44
4.5.2.1	Scope of delivery .....	44
4.5.2.2	Installation and connection of the freshwater bag (CBF / CBF-UL).....	44
4.5.2.3	Refilling the already installed freshwater bag.....	45
4.5.2.4	Replacing the tube connectors for freshwater supply .....	46
4.5.3	Water supply via prefilled water bottle (optional humidification water set).....	47
4.5.3.1	Scope of delivery .....	47
4.5.3.2	Installation, connection and change of the prefilled water bottle .....	47
4.5.4	Water supply via freshwater can (optional water container set).....	49
4.5.4.1	Scope of delivery .....	50
4.5.4.2	Installation and connection of the freshwater can (optional water container set) .....	50
4.5.4.3	Refilling the freshwater can .....	52
4.6	Electrical connection .....	53
4.7	Divided inner door with cell therapy compartmentation (optional).....	54
4.7.1	Special model CBF 260 “Cell Therapy” .....	54
4.7.2	Handling and aligning the divided inner door .....	55
4.7.3	Mounting the partition walls for cell therapy compartmentation .....	56
<b>5.</b>	<b>FUNCTIONAL OVERVIEW OF THE MB2 CHAMBER CONTROLLER.....</b>	<b>58</b>
5.1	Operating functions in normal display .....	59
5.2	Display views: Normal display, program display, chart-recorder display.....	60
5.3	Controller icons overview .....	61
5.4	Operating modes.....	63
5.5	Controller menu structure.....	63
5.5.1	Main menu .....	64
5.5.2	“Settings” submenu.....	65
5.5.3	“Service” submenu.....	65
5.6	Principle of controller entries.....	66
5.7	Performance during and after power failures.....	66
5.8	Performance when opening the door .....	67
<b>6.</b>	<b>START UP .....</b>	<b>67</b>
6.1	Turning on the chamber .....	67
6.2	Controller settings upon start up .....	68
6.3	Factory settings.....	69
6.4	Equilibration time.....	69
6.5	Operating the DuoDoor™ door lock.....	70
6.6	Required gas supply for the chamber with O <sub>2</sub> control.....	70
6.6.1	Hypoxic control range 0.2 vol.-% up to 20 vol.-% O <sub>2</sub> (regular).....	70
6.6.2	Alternative control range 10 vol.-% up to 90 vol.-% (option) .....	70
6.6.3	Operation without O <sub>2</sub> control.....	71
6.7	Activating / deactivating CO <sub>2</sub> , O <sub>2</sub> and humidity control .....	71
6.8	CB / CB-UL: Humidity control of the Permadyr™ system.....	72
<b>7.</b>	<b>SET-POINT ENTRY IN “FIXED VALUE” OPERATING MODE.....</b>	<b>73</b>
7.1	Set-point entry through the “Setpoints” menu .....	74
7.2	Direct setpoint entry via Normal display.....	75
7.3	Special controller functions via operation lines .....	76
7.4	Safety instructions for setting high gas concentrations.....	77
<b>8.</b>	<b>TIMER PROGRAM: STOPWATCH FUNCTION .....</b>	<b>78</b>
8.1	Starting a timer program .....	78
8.1.1	Performance during program delay time .....	78
8.2	Cancelling a running timer program.....	78
8.3	Performance after the end of the program.....	79
<b>9.</b>	<b>TIME PROGRAMS .....</b>	<b>79</b>
9.1	Starting an existing time program .....	79
9.1.1	Performance during program delay time .....	80

---

9.2	Stopping a running time program.....	80
9.2.1	Pausing a running time program.....	80
9.2.2	Cancelling a running time program.....	80
9.3	Performance after the end of the program.....	80
9.4	Creating a new time program.....	81
9.5	Program editor: program management.....	81
9.5.1	Deleting a time program.....	82
9.6	Section editor: section management.....	83
9.6.1	Add a new program section.....	84
9.6.2	Copy and insert or replace a program section.....	84
9.6.3	Deleting a program section.....	85
9.7	Value entry for a program section.....	86
9.7.1	Section duration.....	86
9.7.2	Set-point ramp and set-point step.....	87
9.7.3	Special controller functions via operation lines.....	89
9.7.4	Setpoint entry.....	90
9.7.5	Tolerance range.....	90
9.7.6	Repeating one or several sections within a time program.....	91
9.7.7	Saving the time program.....	92
<b>10.</b>	<b>WEEK PROGRAMS.....</b>	<b>92</b>
10.1	Starting an existing week program.....	92
10.2	Cancelling a running week program.....	93
10.3	Creating a new week program.....	93
10.4	Program editor: program management.....	94
10.4.1	Deleting a week program.....	95
10.5	Section editor: section management.....	96
10.5.1	Add a new program section.....	97
10.5.2	Copy and insert or replace a program section.....	97
10.5.3	Deleting a program section.....	98
10.6	Value entry for a program section.....	98
10.6.1	Set-point ramp and set-point step modes.....	98
10.6.2	Weekday.....	99
10.6.3	Start time.....	99
10.6.4	Setpoint entry.....	100
10.6.5	Special controller functions via operation lines.....	100
<b>11.</b>	<b>NOTIFICATION AND ALARM FUNCTIONS.....</b>	<b>101</b>
11.1	Notification and alarm messages overview.....	101
11.1.1	Notifications.....	101
11.1.2	Alarm messages.....	102
11.2	State of alarm.....	104
11.3	Resetting an alarm, list of active alarms.....	104
11.4	Activating / deactivating the audible alarm (alarm buzzer).....	105
11.5	Tolerance range settings and alarm delay times.....	105
11.6	Zero-voltage relay alarm output.....	107
<b>12.</b>	<b>TEMPERATURE SAFETY DEVICES.....</b>	<b>108</b>
12.1	Over temperature protective device (class 1).....	108
12.2	Overtemperature safety controller class 3.1.....	108
12.2.1	Safety controller modes.....	109
12.2.2	Setting the safety controller.....	109
12.2.3	Message and measures in the state of alarm.....	110
12.2.4	Function check.....	110
<b>13.</b>	<b>USER MANAGEMENT.....</b>	<b>111</b>
13.1	Authorization levels and password protection.....	111
13.2	Log in.....	114
13.3	Log out.....	115

---

13.4	User change .....	115
13.5	Password assignment and password change .....	116
13.5.1	Password change .....	116
13.5.2	Deleting the password for an individual authorization level .....	118
13.5.3	New password assignment for "service" or "admin" authorization level when the password function was deactivated .....	119
13.6	Activation code .....	120
<b>14.</b>	<b>GENERAL CONTROLLER SETTINGS .....</b>	<b>121</b>
14.1	Selecting the controller's menu language .....	121
14.2	Setting date and time .....	121
14.3	Selecting the temperature unit .....	123
14.4	Display configuration .....	123
14.4.1	Adapting the display parameters .....	123
14.4.2	Touchscreen calibration .....	124
14.5	Network and communication .....	125
14.5.1	Serial RS485 interface (available via BINDER INDIVIDUAL Customized Solutions) .....	125
14.5.2	Ethernet .....	126
14.5.2.1	Configuration .....	126
14.5.2.2	Display of MAC address .....	127
14.5.3	E-Mail .....	127
14.6	USB menu: Data transfer via USB interface .....	128
14.6.1	Controller firmware update .....	129
<b>15.</b>	<b>GENERAL INFORMATION .....</b>	<b>130</b>
15.1	Service contact page .....	130
15.2	Current operating parameters .....	130
15.3	Event list .....	131
15.4	Technical chamber information .....	131
<b>16.</b>	<b>CHART RECORDER DISPLAY .....</b>	<b>132</b>
16.1	Views .....	132
16.1.1	Show and hide legend .....	132
16.1.2	Switch between legend pages .....	132
16.1.3	Show and hide specific indications .....	133
16.1.4	History display .....	133
16.2	Setting the parameters .....	136
<b>17.</b>	<b>CBF / CBF-UL: HUMIDIFICATION SYSTEM .....</b>	<b>137</b>
17.1	Function of the humidifying system .....	137
17.2	Function of the dehumidifying system .....	138
<b>18.</b>	<b>OPTIONS .....</b>	<b>138</b>
18.1	APT-COM™ 4 Multi Management Software (option) .....	138
18.2	Silicone access ports 30 mm / 1.18 in, closable from both sides with silicon plugs (option) .....	138
18.3	Quick sample access (option) .....	139
18.4	Interior socket 230V (option, available via BINDER INDIVIDUAL Customized Solutions) .....	140
18.5	Analog outputs for temperature and CO <sub>2</sub> (option) .....	141
18.6	Access port for extra-low voltage (option) .....	142
18.7	BINDER Gas Supply Service – External bottle changer for CO <sub>2</sub> , N <sub>2</sub> or O <sub>2</sub> (option) .....	143
18.8	Stands .....	143
18.8.1	Flat stacking adapter for thermally decoupled stacking (option) .....	143
18.8.2	Stacking stand on castors with castors lockable by breaks (option) .....	143
18.8.3	Base on castors (option) .....	144
18.9	Water supply sets (optional for CBF / CBF-UL) .....	144
18.9.1	Tubular bag set (option) .....	144
18.9.2	Humidification water set (option) .....	144
18.9.3	Water container set (option) .....	144

<b>19. REFERENCE MEASUREMENTS .....</b>	<b>144</b>
19.1 CO <sub>2</sub> reference measuring .....	145
19.1.1 Measuring CO <sub>2</sub> concentration indirectly via the pH of the cell medium .....	145
19.1.2 Measuring CO <sub>2</sub> directly via chemical indicator tubes .....	146
19.1.3 Measuring CO <sub>2</sub> directly with an electronic infrared measuring device .....	146
19.2 Temperature reference measurement .....	146
<b>20. AVOIDING MICROBIAL CONTAMINATION.....</b>	<b>146</b>
20.1 Cells and media .....	146
20.2 Laboratory conditions / equipment around the incubator .....	147
20.3 Working and behavior in the lab .....	147
20.4 Chamber design and equipment of the CO <sub>2</sub> incubator .....	147
20.5 Handling the CO <sub>2</sub> incubator .....	148
<b>21. CLEANING, DECONTAMINATION / DISINFECTION, AND STERILIZATION..</b>	<b>149</b>
21.1 Cleaning .....	150
21.2 Decontamination / chemical disinfection of the chamber .....	151
21.2.1 Disinfection of the CO <sub>2</sub> sensor .....	153
21.2.2 CBF / CBF-UL: Disinfection of components of the fresh water supply system .....	153
21.3 Hot-air sterilization .....	153
21.3.1 Overview .....	153
21.3.2 Preparation for a hot-air sterilization .....	154
21.3.3 Starting the sterilization cycle and running the hot-air sterilization .....	155
21.3.4 Prematurely terminating the sterilization cycle .....	157
21.3.4.1 Prematurely terminating the sterilization cycle after less than 4 hours: Ineffective sterilization .....	157
21.3.4.2 Prematurely terminating the sterilization cycle after more than 4 hours, i.e., during the cooling-down phase: successful sterilization .....	158
21.3.5 Completing the entire sterilization cycle .....	159
<b>22. MAINTENANCE AND SERVICE, TROUBLESHOOTING, REPAIR, TESTING.</b>	<b>159</b>
22.1 General information, personnel qualification .....	159
22.2 CBF / CBF-UL: Replacing components of the humidifying / dehumidifying system .....	160
22.2.1 Replacing the silicone tube of the fresh water supply system .....	160
22.2.2 Replacing the pump head of the fresh water supply system .....	160
22.2.3 Replacing the gas fine filter (sterile filter) for ambient air .....	160
22.3 Replacing the CO <sub>2</sub> und O <sub>2</sub> /N <sub>2</sub> gas inlet fine filters (sterile filters) .....	161
22.4 Replacing the CO <sub>2</sub> sensor .....	162
22.5 Maintenance intervals, service .....	163
22.6 Simple troubleshooting .....	164
22.6.1 General .....	164
22.6.2 Heating .....	165
22.6.3 Gas cylinder pressure too low .....	166
22.6.4 Gas control .....	167
22.6.5 Sterilization .....	169
22.6.6 Humidity (CB / CB-UL) .....	169
22.6.7 Humidity (CBF / CBF-UL) .....	170
22.6.8 Controller .....	170
22.6.9 Open door .....	171
22.7 Sending the chamber back to BINDER GmbH .....	171
<b>23. DISPOSAL.....</b>	<b>172</b>
23.1 Disposal of the transport packing .....	172
23.1.1 Outer chamber packing .....	172
23.1.2 Packing inside the chamber and equipment .....	172
23.2 Decommissioning .....	173
23.3 Disposal of the chamber in the Federal Republic of Germany .....	173

---

23.4	Disposal of the chamber in the member states of the EU except for the Federal Republic of Germany.....	174
23.5	Disposal of the chamber in non-member states of the EU .....	176
<b>24.</b>	<b>TECHNICAL DESCRIPTION.....</b>	<b>176</b>
24.1	Factory calibration and adjustment .....	176
24.2	Over current protection .....	176
24.3	Definition of usable volume .....	177
24.4	Technical data .....	177
24.5	Equipment and Options (extract) .....	180
24.6	Accessories and spare parts (extract) .....	181
24.7	Important conversion data for non-SI units .....	184
24.8	Conversion table for gas inlet pressures, bar – psi.....	184
24.9	Dimensions.....	185
24.9.1	Chamber size 56.....	185
24.9.2	Chamber size 170.....	186
24.9.3	Chamber size 260.....	187
<b>25.</b>	<b>CERTIFICATES AND DECLARATIONS OF CONFORMITY.....</b>	<b>188</b>
25.1	EU Declaration of conformity for CB .....	188
25.2	EU Declaration of conformity for CBF .....	190
25.3	UKCA Declaration of Conformity for CB .....	192
25.4	UKCA Declaration of Conformity for CBF .....	193
<b>26.</b>	<b>CONTAMINATION CLEARANCE CERTIFICATE .....</b>	<b>194</b>
26.1	For chambers located outside the USA and Canada .....	194
26.2	For chambers in the USA and Canada .....	197

Dear customer,

For the correct operation of the CO<sub>2</sub> incubator, it is important that you read this operating manual completely and carefully and observe all instructions as indicated. Failure to read, understand and follow the instructions may result in personal injury. It can also lead to damage to the chamber and/or poor equipment performance

## 1. Safety

### 1.1 Personnel Qualification



The chamber must only be installed, tested, and started up by personnel qualified for assembly, startup, and operation of the chamber. Qualified personnel are persons whose professional education, knowledge, experience and knowledge of relevant standards allow them to assess, carry out, and identify any potential hazards in the work assigned to them. They must have been trained and instructed, and be authorized, to work on the chamber.

The chamber should only be operated by laboratory personnel especially trained for this purpose and familiar with all precautionary measures required for working in a laboratory. Observe the national regulations on minimum age of laboratory personnel.

### 1.2 Operating manual

This operating manual is part of the components of delivery. Always keep it handy for reference in the vicinity of the chamber. If selling the unit, hand over the operating manual to the purchaser.

To avoid injuries and damage observe the safety instructions of the operating manual. Failure to follow instructions and safety precautions can lead to significant risks.

	<div data-bbox="391 1120 1495 1205" style="background-color: red; color: white; text-align: center;"> <b>DANGER</b></div> <p><b>Dangers due to failure to observe the instructions and safety precautions. Serious injuries and chamber damage. Risk of death.</b></p> <ul style="list-style-type: none"><li>➤ Observe the safety instructions in this Operating Manual.</li><li>➤ Follow the operating procedures in this Operating Manual.</li><li>➤ Carefully read the complete operating instructions of the chamber prior to installing and using the chamber.</li><li>➤ Keep the operating manual for future reference</li></ul>
---	---

	Make sure that all persons who use the chamber and its associated work equipment have read and understood the Operating Manual.
---	---

This Operating Manual is supplemented and updated as needed. Always use the most recent version of the Operating Manual. When in doubt, call the BINDER Service Hotline for information on the up-to-dateness and validity of this Operating Manual.

### 1.3 Legal considerations

This operating manual is for informational purposes only. It contains information for correct and safe installing, start-up, operation, decommissioning, cleaning and maintenance of the product. Note: the contents and the product described are subject to change without notice.

Understanding and observing the instructions in this operating manual are prerequisites for hazard-free use and safety during operation and maintenance. Images are to provide basic understanding. They may deviate from the actual version of the chamber. The actual scope of delivery can, due to optional or special design, or due to recent technical changes, deviate from the information and illustrations in these instructions this operating manual.



In no event shall BINDER be held liable for any damages, direct or incidental arising out of or related to the use of this manual.

This operating manual cannot cover all conceivable applications. If you would like additional information, or if special problems arise that are not sufficiently addressed in this manual, please ask your dealer or contact us directly, e.g. by phone at the number located on page one of this manual

Furthermore, we emphasize that the contents of this operating manual are not part of an earlier or existing agreement, description, or legal relationship, nor do they modify such a relationship. All obligations on the part of BINDER derive from the respective purchase contract, which also contains the entire and exclusively valid statement of warranty administration and the general terms and conditions, as well as the legal regulations valid at the time the contract is concluded. The statements in this manual neither augment nor restrict the contractual warranty provisions.

### 1.3.1 Intellectual property

**This operating manual is protected by copyright. Any unauthorized copying or disclosure to third parties is strictly prohibited. We reserve the right to take legal action and, if necessary, to assert claims for damages in the event of infringement.**

**Trademark Information:** All BINDER trademarks relating to products or service, as well as trade names, logos and product names used on the website, products and documents of BINDER company are trademarks or registered trademarks of BINDER company (including BINDER GmbH, BINDER Inc.) in the U.S. and other countries and communities of states. This includes word marks, position marks, word/figurative marks, design configurations, figurative marks, and design patents.

**Patent Information:** BINDER products, categories of products, and accessories may be covered by one or more patents and/or utility models in the U.S. and other countries and communities of states. This information is provided to satisfy the virtual patent marking provisions of various jurisdictions, in particular it is intended to serve as notice under 35 U.S.C. § 287(a). Products and services listed on the BINDER website may be sold individually or as part of a combination product. Additional patent applications may also be pending in the U.S. and other countries and communities of states.

Please visit [www.binder-world.com](http://www.binder-world.com) for more information.

## 1.4 Structure of the safety instructions

In this operating manual, the following safety definitions and symbols indicate dangerous situations following the harmonization of ISO 3864-2 and ANSI Z535.6.

### 1.4.1 Signal word panel

Depending on the probability of serious consequences, potential dangers are identified with a signal word, the corresponding safety color, and if appropriate, the safety alert symbol.

 <b>DANGER</b>
Indicates an imminently hazardous situation that, if not avoided, will result in death or serious (irreversible) injury.

 <b>WARNING</b>
Indicates a potentially hazardous situation which, if not avoided, could result in death or serious (irreversible) injury.

**CAUTION**

Indicates a potentially hazardous situation which, if not avoided, may result in moderate or minor (reversible) injury.

**NOTICE**

Indicates a potentially hazardous situation which, if not avoided, may result in damage to the product and/or its functions or of a property in its proximity.























### 1.4.2 Safety alert symbol





Use of the safety alert symbol indicates a **risk of injury**.

Observe all measures that are marked with the safety alert symbol in order to avoid death or injury.

### 1.4.3 Pictograms

Warning signs			
 Electrical hazard	 Hot surface	 Explosive atmosphere	 Stability hazard
 Lifting hazard	 Gas cylinders	 Suffocation hazard	 CO <sub>2</sub> suffocation and poisoning hazard
 Explosive substances	 Fire promoting agents	 Harmful substances	 Risk of corrosion and / or chemical burns
 Biohazard	 Pollution Hazard	 Magnetic field	 High humidity
Mandatory action signs			
 Mandatory regulation	 Read operating instructions	 Disconnect the power plug	 Lift with several persons
 Environment protection	 Wear protective gloves	 Wear safety goggles	

Prohibition signs			
 Do NOT touch	 Do NOT spray with water		

	<b>Information</b> to be observed in order to ensure optimum function of the product.
---	---





#### 1.4.4 Word message panel structure

<p><b>Type / cause of hazard.</b></p> <p><b>Possible consequences.</b></p> <ul style="list-style-type: none"> <li>➤ Instruction how to avoid the hazard: prohibition</li> <li>➤ Instruction how to avoid the hazard: mandatory action</li> </ul>
--

Observe all other notes and information not necessarily emphasized in the same way, in order to avoid disruptions that could result in direct or indirect injury or property damage.

#### 1.5 Localization / position of safety labels on the chamber

The following labels are located on the chamber:



Pictograms (Warning signs)	Service label
 <p>Hot surface</p> <ul style="list-style-type: none"> <li>• on the outer chamber door</li> </ul>	
 <p>Risk of injury</p> <ul style="list-style-type: none"> <li>• on the outer door: CB-UL / CBF-UL only</li> <li>• above the access ports (option)</li> </ul>	
 <p>Magnetic field</p> <ul style="list-style-type: none"> <li>• on the outer door above the door handle</li> </ul>	



### Indications of the type plate (example)

Indication		Information
BINDER		Manufacturer: BINDER GmbH
CB 170		Model designation
CO2 incubator		Device name
Serial No.	00000000000000	Serial no. of the chamber
Built	2024	Year of construction
Nominal temperature	180 °C 356 °F	Nominal temperature
IP protection	20	IP type of protection acc. to standard EN 60529
Temp. safety device	DIN 12880	Temperature safety device acc. to standard DIN 12880
Class	3.1	Class of temperature safety device
Art. No.	9640-0009	Art. No. of the chamber
Var.	9640-0025	Variant No. / Equipment
Project No.	---	Optional: Special application acc. to project no.
1,30 kW		Nominal power
200-230 V / 50 Hz		Nominal voltage range +/-10% at the indicated power frequency
200-230 V / 60 Hz		
1 N ~		Current type
5,7 A		Nominal current

### Symbols on the type plate

Symbol	Information
	CE conformity marking
	Electrical and electronic equipment manufactured / placed on the market in the EC after 13 August 2005 and to be disposed of in separate collection according to Directive 2012/19/EU on waste electrical and electronic equipment (WEEE).
	The chamber is certified according to Customs Union Technical Regulation (CU TR) for the Eurasian Economic Union (Russia, Belarus, Armenia, Kazakhstan Kyrgyzstan).

### 1.7 UKCA Label

The sticker with UKCA Authorised Representative details sticks next to the type plate to the left side of the chamber, bottom right-hand.



Figure 4: UKCA Label

### Symbol on the sticker

Symbol	Applies to	Information
	All models except UL models	UKCA conformity marking

## 1.8 General safety instructions on installing and operating the CO<sub>2</sub> incubator



With regard to operating the chamber and to the installation location, please observe the local and national regulations relevant for your country (for Germany: DGUV guidelines 213-850 on safe working in laboratories, issued by the employers' liability insurance association).

BINDER GmbH is only responsible for the safety features of the chamber provided skilled electricians or qualified personnel authorized by BINDER perform all maintenance and repair, and if components relating to chamber safety are replaced in the event of failure with original spare parts.



To operate the chamber, use only original BINDER accessories or accessories from third-party suppliers authorized by BINDER. The user is responsible for any risk caused by using unauthorized accessories.

	NOTICE
	<p><b>Danger of overheating due to lack of ventilation.</b>  <b>Damage to the chamber.</b></p> <ul style="list-style-type: none"> <li>⊘ Do NOT install the chamber in unventilated recesses.</li> <li>➤ Ensure sufficient ventilation for dispersal of the heat.</li> <li>➤ Observe the prescribed minimum distances when installing the chamber (chap. 3.4).</li> </ul>

Do not install or operate the chamber in hazardous locations.



	 <b>DANGER</b>
	<p><b>Danger of explosion due to combustible dusts or explosive mixtures in the vicinity of the chamber.</b>  <b>Serious injury or death from burns and / or explosion pressure.</b></p> <ul style="list-style-type: none"> <li>⊘ Do NOT operate the chamber in potentially explosive areas.</li> <li>➤ KEEP combustible dust or air-solvent mixtures AWAY from the chamber.</li> </ul>

The chamber does not dispose of any measures of explosion protection.

	 <b>DANGER</b>
	<p><b>Danger of explosion due to introduction of flammable or explosive substances in the chamber.</b>  <b>Serious injury or death from burns and / or explosion pressure.</b></p> <ul style="list-style-type: none"> <li>⊘ Do NOT introduce any substance into the chamber which is combustible or explosive at working temperature.</li> <li>⊘ Do NOT introduce any combustible dust or air-solvent mixture in the inner chamber.</li> </ul>

Any solvent contained in the charging material must not be explosive or inflammable. I.e., irrespective of the solvent concentration in the steam room, NO explosive mixture with air must form. The temperature inside the chamber must lie below the flash point or below the sublimation point of the charging material. Familiarize yourself with the physical and chemical properties of the charging material, as well as the contained moisture constituent and its behavior with the addition of heat energy and humidity (CBF / CBF-UL).



Familiarize yourself with any potential health risks caused by the charging material, the contained moisture constituent or by reaction products which may arise during the temperature process. Take adequate measures to exclude such risks prior to putting the chamber into operation.



 	 <b>WARNING</b>
	<p><b>Danger of intoxication and infection through contamination of the chamber with toxic, infectious or radioactive substances.</b></p> <p><b>Damages to health.</b></p> <ul style="list-style-type: none"> <li>➤ Protect the interior of the chamber from contamination by toxic, infectious or radioactive substances.</li> <li>➤ Take suitable protective measures when introducing and removing toxic, infectious or radioactive material</li> </ul>

	 <b>DANGER</b>
	<p><b>Electrical hazard by water entering the chamber.</b></p> <p><b>Deadly electric shock.</b></p> <ul style="list-style-type: none"> <li>⊘ The chamber must NOT become wet during operation, cleaning, or maintenance.</li> <li>⊘ Do NOT install the chamber in damp areas or in puddles.</li> <li>➤ Set up the chamber in a splash-proof manner.</li> </ul>



The chambers were produced in accordance with VDE regulations and were routinely tested in accordance to VDE 0411-1 (IEC 61010-1).

During and after a sterilization the temperature of the inner surfaces almost equals the set-point. The inner doors, the inner door and glass door handles, and the inner chamber will become hot during a sterilization.

	 <b>CAUTION</b>
	<p><b>Danger of burning by touching hot chamber parts during or after a sterilization.</b></p> <p><b>Burns.</b></p> <ul style="list-style-type: none"> <li>⊘ Do NOT touch the inner surfaces, inner doors, inner door handles, and door gaskets during or after a sterilization.</li> </ul>

	 <b>WARNING</b>
	<p><b>Danger of injury and damages by the chamber tipping over.</b></p> <p><b>Injuries and damage to the chamber and the charging material</b></p> <ul style="list-style-type: none"> <li>⊘ Do NOT load the chamber door with heavy objects while it is open.</li> </ul>



The chamber is equipped with a permanent magnet located behind the inner panel of the outer chamber door. If persons with active implants (e.g. pacemakers, defibrillators) keep a sufficient safe distance (distance of field source to implant), an influence of these implants can be excluded with high probability.

	 <b>WARNING</b>
	<p><b>Magnets can affect the function of pacemakers and implanted defibrillators.</b></p> <p><b>A pacemaker can be put into test mode and cause discomfort. A defibrillator may not work anymore.</b></p> <ul style="list-style-type: none"> <li>➤ If you wear such devices, maintain a sufficient safety distance to the chamber door in the area of the door handle.</li> <li>➤ Warn wearers of such devices of approaching the chamber door.</li> </ul>

## 1.9 Precautions when working with gases



### Notes on handling carbon dioxide (CO<sub>2</sub>)

Carbon dioxide (CO<sub>2</sub>) in high concentrations is hazardous to health. It is colorless and almost odorless and therefore practically imperceptible. Vent out any CO<sub>2</sub> gas that may escape via good room ventilation or a suitable connection to an exhaust system. We recommend installing a CO<sub>2</sub> warning system.

	 <b>DANGER</b>
	<p><b>Danger of suffocation and poisoning by high concentration of CO<sub>2</sub> (&gt; 4 Vol.-%).</b>  <b>Death by suffocation.</b></p> <ul style="list-style-type: none"> <li>⊘ Do NOT set up chambers in non-ventilated recesses.</li> <li>➤ Ensure technical ventilation measures.</li> <li>➤ Observe the relevant regulations for handling CO<sub>2</sub>.</li> <li>➤ Close the CO<sub>2</sub> supply when decommissioning the chamber.</li> </ul>

### Chamber with O<sub>2</sub> control: Notes on handling oxygen (O<sub>2</sub>)

Oxygen (O<sub>2</sub>) is colorless and almost odorless and therefore practically imperceptible. It promotes burns, which can proceed explosively. There is a fire hazard for flammable oxygenated materials, e.g. clothes and hair. O<sub>2</sub> is heavier than air and may accumulate in low-lying areas.

	 <b>DANGER</b>
	<p><b>Danger of fire and explosion through contact of combustible materials with O<sub>2</sub> with high concentration of O<sub>2</sub> (&gt; 21 % O<sub>2</sub>).</b>  <b>Serious injury or death from burns and / or explosion pressure.</b></p> <ul style="list-style-type: none"> <li>⊘ Do NOT set up chambers in non-ventilated recesses.</li> <li>➤ Ensure technical ventilation measures.</li> <li>➤ Observe the relevant regulations for handling O<sub>2</sub>.</li> <li>➤ Close the O<sub>2</sub> supply when decommissioning the chamber.</li> </ul>



Take appropriate measures to prevent oxygen enrichment and fire and explosion hazards in areas where oxygen enrichment is possible.



	<p>General information for safe handling of oxygen:</p> <ul style="list-style-type: none"> <li>• Make sure training of personnel on hazards of oxygen enrichment and necessary safety measures.</li> <li>• Make sure adequate labeling of all oxygen equipment and facilities.</li> <li>• Make sure gas tightness of all gas connections by checking them for leaks (e.g. with leak spray or diluted soap solution).</li> <li>• Close the main valve of the source of oxygen after work when not using the chamber.</li> <li>• Never lubricate O<sub>2</sub> equipment with oil or fat. Use only materials and spare parts which are approved for use with oxygen.</li> <li>• Regularly inspect fire extinguishers for proper condition.</li> <li>• Set up emergency showers where oxygen enrichment is possible.</li> <li>• Strictest smoking ban and no ignition sources in areas where oxygen enrichment is possible.</li> <li>• Make sure good ventilation of areas where oxygen enrichment is possible (location of the chamber and/or O<sub>2</sub> cylinders).</li> <li>• Persons who may have been in a possibly oxygen-enriched atmosphere must keep away from ignition sources (flames, cigarettes, etc.) and ventilate their clothes at least 15 minutes.</li> <li>• Always keep emergency routes free.</li> </ul>
---	---

#### **Chamber with O<sub>2</sub> control: Notes on handling nitrogen (N<sub>2</sub>)**



Nitrogen (N<sub>2</sub>) in high concentrations is hazardous to health. It is colorless and almost odorless and therefore practically imperceptible. Any N<sub>2</sub> gas that may escape must be safely led out via good room ventilation or a suitable connection to an exhaust system.

	 <b>DANGER</b>
	<p><b>Risk of suffocation through high concentration of N<sub>2</sub>.</b>  <b>Death by suffocation.</b></p> <ul style="list-style-type: none"> <li>⊘ Do NOT set up chambers in non-ventilated recesses.</li> <li>➤ Ensure technical ventilation measures.</li> <li>➤ Observe the relevant regulations for handling N<sub>2</sub>.</li> <li>➤ Close the N<sub>2</sub> supply when decommissioning the chamber.</li> </ul>



### **1.10 Precautions when handling gas cylinders**

	<p>General information for safe handling of gas cylinders:</p> <ul style="list-style-type: none"> <li>• Store and use gas cylinders only in well-ventilated locations.</li> <li>• Open the gas cylinder valve slowly to avoid pressure surges.</li> <li>• Secure gas cylinders during storage and use against falling (chaining).</li> <li>• Transport gas cylinders with a cylinder cart, do not carry, roll, or throw them.</li> <li>• Always close the valve even with apparently empty cylinders; screw on the cap when not in use. Return gas cylinders with the valve closed.</li> <li>• Do not open gas cylinders by force. Mark them when damaged.</li> <li>• Protect gas cylinders against fire, e.g. do not store together with flammable liquids.</li> <li>• Observe relevant regulations for dealing with gas cylinders.</li> </ul>
---	---

Secure the gas cylinders against falling and other mechanical damage.

	 <b>WARNING</b>
	<p><b>Risk of injury through sudden release of the stored pressure energy when the valve safety is torn off.</b></p> <p><b>Injuries.</b></p> <ul style="list-style-type: none"> <li>➤ Secure gas cylinders against falling (chaining).</li> <li>➤ Transport gas cylinders with a cylinder cart.</li> </ul>

The valve of the gas cylinder **always** must be closed before screwing on or unscrewing the gas hose.

	 <b>WARNING</b>
	<p><b>Risk of injury through sudden release of the stored pressure energy when opening the cylinder valve of a not connected cylinder.</b></p> <p><b>Injuries.</b></p> <ul style="list-style-type: none"> <li>➤ Close the gas cylinder valve before connecting or removing the gas hose.</li> </ul>

	<p>After connecting the gas cylinder, check all gas connections for leaks (e.g. with leak spray or diluted soap solution).</p>
---	--

### 1.11 Intended use

	<p>Following the instructions in this operating manual and conducting regular maintenance work (chap. 22.5) are part of the intended use.</p>
---	---

**Any use of the chambers that does not comply with the requirements specified in this Operating Manual shall be considered improper use.**

**Other applications than those described in this chapter are not approved.**

#### Use

CB / CB-UL and CBF / CBF-UL incubators are suitable for the cultivation of mammal cells under typical conditions of approx. 37 °C / 98.6°F. The chamber permits setting defined pH conditions by common NaHCO<sub>3</sub> buffer systems of commercial cell media by keeping an exact CO<sub>2</sub> atmosphere inside. The chambers guarantee high humidity inside to avoid osmolarity increasing caused by the evaporation of the cell media.

With the chamber with O<sub>2</sub> control, a variable oxygen atmosphere can additionally influence the growth of the cells.



The chambers are suitable for exact conditioning of harmless materials.

#### Requirements for the chamber load



Any solvent must not be explosive and flammable. Components of the charging material must NOT form an explosive mixture with air. The operating temperature must lie below the flash point or below the sublimation point of the charging material. Any component of the charging material must NOT be able to release toxic gases.

The charging material shall not contain any corrosive ingredients that may damage the machine components made of stainless steel, aluminum, and copper. Such ingredients include in particular acids and halides. Any corrosive damage caused by such ingredients is excluded from liability by BINDER GmbH.

The chamber does not dispose of any measures of explosion protection.

 	 <b>DANGER</b>
	<p><b>Explosion or implosion hazard and danger of poisoning through the introduction of unsuitable loading material.</b></p> <p><b>Poisoning. Serious injury or death from burns and / or explosion pressure.</b></p> <ul style="list-style-type: none"> <li>⊘ Do NOT introduce any substance combustible or explosive at working temperature into the chamber, in particular no energy sources such as batteries or lithium-ion batteries.</li> <li>⊘ NO explosive dust or air-solvent mixture in the inner chamber.</li> <li>⊘ Do NOT introduce any substance which could lead to release of toxic gases.</li> </ul>

Contamination of the chamber by toxic, infectious or radioactive substances must be prevented

 	 <b>WARNING</b>
	<p><b>Danger of intoxication and infection through contamination of the chamber with toxic, infectious or radioactive substances.</b></p> <p><b>Damages to health.</b></p> <ul style="list-style-type: none"> <li>➤ Protect the interior of the chamber from contamination by toxic, infectious or radioactive substances.</li> <li>➤ Take suitable protective measures when introducing and removing toxic, infectious or radioactive material</li> </ul>

In case of foreseeable use of the chamber there is no risk for the user through the integration of the chamber into systems or by special environmental or operating conditions in the sense of EN 61010-1:2010. For this, the intended use of the chamber and all its connections must be observed.

### Medical devices

The chambers are not classified as medical devices as defined by Regulation (EU) No 2017/745.

	<p>Due to the special demands of the Medical Products legislation, these chambers are not qualified to perform sterilization of medical devices as defined by Regulation (EU) No 2017/745.</p>
---	--

### Personnel Requirements

Only trained personnel with knowledge of the Operating Manual can set up and install the chamber, start it up, operate, clean, and take it out of operation. Service and repairs call for further technical requirements (e.g. electrical know-how), as well as knowledge of the service manual.

### Installation site requirements

The chambers are designed for setting up inside a building (indoor use).

The requirements described in the Operating Manual for installation site and ambient conditions (Chap. 3.4) must be met.

	<p><b>WARNING:</b> If customer should use a BINDER chamber running in non-supervised continuous operation, we strongly recommend in case of inclusion of irrecoverable specimen or samples to split such specimen or samples and store them in at least two chambers, if this is feasible.</p>
---	--

Relevant regulations for dealing with CO<sub>2</sub> / O<sub>2</sub> / N<sub>2</sub> and gas cylinders must be observed.

## 1.12 Foreseeable Misuse

Other applications than those described in chap. 1.11 are not approved.

This expressly includes the following misuses (the list is not exhaustive), which pose risks despite the inherently safe construction and existing technical safety equipment:

- Non-observance of Operating Manual
- Non-observance of information and warnings on the chamber (e.g. control unit messages, safety identifiers, warning signals)
- Installation, startup, operation, maintenance and repair by untrained, insufficiently qualified, or unauthorized personnel
- Missed or delayed maintenance and testing
- Non-observance of traces of wear and tear
- Insertion of materials excluded or not permitted by this Operating Manual.
- Non-compliance with the admissible parameters for processing the respective material.
- Failure to comply with the relevant regulations for handling gas cylinders
- Failure to comply with the relevant regulations for handling CO<sub>2</sub> , O<sub>2</sub> or N<sub>2</sub>
- Operation of the chamber without ventilation measures
- Installation, testing, service or repair in the presence of solvents
- Installation of replacement parts and use of accessories and operating resources not specified and authorized by the manufacturer
- Installation, startup, operation, maintenance or repair of the chamber in absence of operating instructions
- Bypassing or changing protective systems, operation of the chamber without the designated protective systems
- Non-observance of messages regarding cleaning and disinfection of the chamber.
- Spilling water or cleaning agent on the chamber, water penetrating into the chamber during operation, cleaning or maintenance.
- Cleaning activity while chamber is turned on.
- Operation of the chamber with a damaged housing or damaged power cord.
- Continued operation of the chamber during an obvious malfunction
- Insertion of objects, particularly metallic objects, in louvers or other openings or slots on the chamber
- Human error (e.g. insufficient experience, qualification, stress, exhaustion, laziness)

To prevent these and other risks from incorrect operation, it is recommended the operator issue operating instructions and standard operating procedures (SOPs).

## 1.13 Residual Risks

The unavoidable design features of a chamber, as well as its proper field of application, can also pose risks, even during correct operation. These residual risks include hazards which, despite the inherently safe design, existing technical protective equipment, safety precautions and supplementary protective measures, cannot be ruled out.

Messages on the chamber and in the Operating Manual warn of residual risks. The consequences of these residual risks and the measures required to prevent them are listed in the Operating Manual. Moreover, the operator must take measures to minimize hazards from unavoidable residual risks. This includes, in particular, issuing operating instructions.

---

The following list summarizes the hazards against which this Operating Manual and the Service Manual warn, and specifies protective measures at the appropriate spots:

**Unpacking, Transport, Installation**

- Sliding or tilting the chamber
- Setup of the chamber in unauthorized areas
- Installation of a damaged chamber
- Installation of a chamber with damaged power cord
- Inappropriate site of installation
- Missing protective conductor connection

**Normal operation**

- Assembly errors
- Contact with hot surfaces on the housing
- Contact with hot surfaces in the interior and inside of doors
- Emission of non-ionizing radiation from electrical operating resources
- Contact with live parts in normal state

**Cleaning and Decontamination**

- Penetration of water into the chamber
- Inappropriate cleaning and decontamination agents
- Enclosure of persons in the interior

**Malfunction and Damage**

- Continued operation of the chamber during an obvious malfunction or outage of the heating, gas, or humidifying systems
- Contact with live parts during error status
- Operation of a unit with damaged power cord

**Maintenance**

- Maintenance work on live parts.
- Execution of maintenance work by untrained/insufficiently qualified personnel
- Electrical safety analysis during annual maintenance not performed

**Trouble-shooting and Repairs**

- Non-observance of warning messages in the Service Manual
- Trouble-shooting of live parts without specified safety measures
- Absence of a plausibility check to rule out erroneous inscription of electrical components
- Performance of repair work by untrained/insufficiently qualified personnel
- Inappropriate repairs which do not meet the quality standard specified by BINDER
- Use of replacement parts other than BINDER original replacement parts
- Electrical safety analysis not performed after repairs

## 1.14 Operating instructions

Depending on the application and location of the chamber, it is recommended that the operator of the chamber provides the relevant information for safe operation of the chamber in a set of operating instructions.



Keep these operating instructions with the chamber at all times in a place where they are clearly visible. They must be comprehensible and written in the language of the employees.

## 1.15 Measures to prevent accidents

The operator of the chamber must observe the local and national regulations and take precautions to prevent accidents.

The manufacturer took the following measures to prevent dangers:

- **Indications on the type plate**

See operating manual chap. 1.6.

- **Operating manual**

An operating manual is available for each chamber.

- **Overtemperature monitoring**

The chamber is equipped with a temperature display, which can be read from outside.

The chamber is equipped with an additional safety controller (temperature safety device class 3.1 acc. to DIN 12880:2007). Visual and audible (buzzer) signals indicate temperature exceeding.

- **Safety, measurement, and control equipment**



The safety, measuring, and control equipment is easily accessible.

- **Electrostatic charge**

The interior parts are grounded.

- **Non-ionizing radiation**

Non-ionizing radiation is not intentionally produced, but released only for technical reasons by electrical equipment (e.g. power cables). The chamber is equipped with a permanent magnet located behind the inner panel of the outer chamber door. If persons with active implants (e.g. pacemakers, defibrillators) keep a sufficient safe distance (distance of field source to implant), an influence of these implants can be excluded with high probability.

	 <b>WARNING</b>
	<p><b>Magnets can affect the function of pacemakers and implanted defibrillators. A pacemaker can be put into test mode and cause discomfort. A defibrillator may not work anymore.</b></p> <ul style="list-style-type: none"> <li>➤ If you wear such devices, maintain a sufficient safety distance to the chamber door in the area of the door handle.</li> <li>➤ Warn wearers of such devices of approaching the chamber door.</li> </ul>

- **Protection against touchable surfaces**

Tested according to EN ISO 13732-1:2008.

- **Floors**

See operating manual chap. 3.4 for correct installation

- **Cleaning**

See operating manual chap. 21.

## 1.16 CBF / CBF-UL : Resistance of the humidity sensor against harmful substances

The following list of harmful substances refers only to the humidity sensor and does not include any other materials incorporated in the chamber or prohibited substances in relation to explosion protection.

Some gases - especially clean gases - do not have any influence on the humidity sensor. Others do have a very small influence, whereas others may influence the sensor to a larger extent.

- The following gases do not influence the sensor and the humidity measurement: Argon (Ar), carbon dioxide (CO<sub>2</sub>), helium (He), hydrogen (H<sub>2</sub>), neon (Ne), nitrogen (N<sub>2</sub>), nitrous oxide (N<sub>2</sub>O), oxygen (O<sub>2</sub>)
- The following gases do not or to a minor extent influence the sensor and the humidity measurement: Butane (C<sub>4</sub>H<sub>10</sub>), ethane (C<sub>2</sub>H<sub>6</sub>), methane (CH<sub>4</sub>), natural gas propane (C<sub>3</sub>H<sub>8</sub>)
- The following gases do not, or to a minor extent influence the sensor and the humidity measurement, provided that the indicated loads are not exceeded:

Substance	Formula	Maximum work place threshold limit value		Tolerated concentration with permanent load	
		ppm	mg/m <sup>3</sup>	ppm	mg/m <sup>3</sup>
Ammonia	NH <sub>3</sub>	20	14	5500	4000
Acetone	CH <sub>3</sub> COCH <sub>3</sub>	500	1200	3300	8000
Benzene		300	1200		150000
Chlorine	Cl <sub>2</sub>	0.5	1.5	0.7	2
Acetic acid	CH <sub>3</sub> COOH	10	25	800	2000
Ethyl acetate	CH <sub>3</sub> COOC <sub>2</sub> H <sub>5</sub>	400	1400	4000	15000
Ethanol	C <sub>2</sub> H <sub>5</sub> OH	500	960	3500	6000
Ethylene glycol	HOCH <sub>2</sub> CH <sub>2</sub> OH	10	26	1200	3000
Formaldehyde	HCHO	0.3	0.37	2400	3000
Isopropanol	(CH <sub>3</sub> ) <sub>2</sub> CHOH	200	500	4800	12000
Methanol	CH <sub>3</sub> OH	200	260	3500	6000
Methyl ethyl ketone	C <sub>2</sub> H <sub>5</sub> COCH <sub>3</sub>	200	590	3300	8000
Ozone	O <sub>3</sub>	0.1	0.2	0.5	1
Hydrochloric acid	HCl	2	3	300	500
Hydrogen sulphide	H <sub>2</sub> S	10	15	350	500
Nitrogen oxides	NO <sub>x</sub>	5	9	5	9
Sulphur dioxide	SO <sub>2</sub>	5	13	5	13
Toluol	C <sub>6</sub> H <sub>5</sub> CH <sub>3</sub>	100	380	1300	5000
Xylene	C <sub>6</sub> H <sub>4</sub> (CH <sub>3</sub> ) <sub>2</sub>	100	440	1300	5000

These values are to be considered as approximate values. The sensor resistance largely depends on the temperature and humidity conditions during the time of exposure to harmful substances. Avoid simultaneous condensation. Tolerated error of measurement: ± 2 %r.H. The maximum work place threshold limit value is one that can be regarded as harmless for humans.

- Vapors of oil and fat are dangerous for the sensor because they may condensate at the sensor and thus prevent its function (insulating layer). For similar reasons it is not possible to measure smoke gases.

## 2. Chamber description

The CO<sub>2</sub> incubators CB / CB-UL and CBF / CBF-UL are equipped with a multifunctional microprocessor display controller for temperature, CO<sub>2</sub>, and O<sub>2</sub> (chamber with O<sub>2</sub> control) levels and humidity (CBF / CBF-UL) and a digital display accurate to one-tenth of a degree resp. 0.1 vol.-%. With its comprehensive program control functions, the display program controller MB2 permits the high precision performance of temperature, CO<sub>2</sub>, O<sub>2</sub> (chamber with O<sub>2</sub> control), and humidity (CBF / CBF-UL) cycles.

**Material:** The inner chamber, the pre-heating chamber and the inside of the doors are all made of stainless steel V2A (German material no. 1.4301, US equivalent AISI 304). The inner surfaces are smooth and therefore easy to clean. The inner chamber is deep-drawn from one piece, polished (suitable for pharmaceutical applications) and has no welds or inaccessible corners. The hinges and the seal of the inner glass door are glued from the outside to aid cleaning of the inner chamber. When operating the chamber at high temperatures (sterilization), the impact of the oxygen in the air may cause discoloration of the metallic surfaces (yellowish-brown or blue) by natural oxidation processes. These colorations are harmless and will in no way impair the function or quality of the chamber. The perforated shelves are also made of stainless steel. You can insert a maximum of 3 (chamber size 56), 6 (chamber size 170), resp. 8 (chamber size 260) shelves. The housing is RAL 7035 powder-coated. All corners and edges are also completely coated.

**Door lock:** The DuoDoor™ door lock offers two to open the outer door and glass door independently or together. The outer door is regularly equipped with a door lock with keys. The standard chamber door is hinged right. The chamber is optionally available with door hinged left.

**Sterilization:** The chamber's heating system permits hot-air auto-sterilization at a setpoint of 180 °C / 356 °F. Thus, the effective sterilization temperature is maintained for at least two hours on all internal surfaces, resulting in sterilization of the entire inner chamber. The effectiveness of the sterilization has also been confirmed by an independent research institute.

**Temperature safety device** Thanks to the regular safety controller (temperature safety device class 3.1 acc. to DIN 12880:2007), the set temperature is maintained in case of failure.

**CO<sub>2</sub> system:** A highly precise, drift-free CO<sub>2</sub> infrared measuring system in combination with the permanent mixture of CO<sub>2</sub> gas through a special proprietary gas mixing head developed by BINDER allows precise and constant CO<sub>2</sub> concentrations for long periods. This creates optimum growth conditions for cultures. The gas enters the chamber via a fine filter (aseptic filter) with a high filtration efficiency that also filters the smallest particles.

Fast reaction times, maximum accuracy and selectivity characterize the CO<sub>2</sub> measuring procedure of the CO<sub>2</sub> incubators. The accuracy of the CO<sub>2</sub> measuring system is based on an infrared measuring cell with NDIR (non-dispersive infrared) sensor, which continuously regulates to a reference value. Therefore, disturbance variables and aging phenomena in the measuring system are almost completely eliminated, so that this measuring system, in contrast to other measuring procedures, remains practically drift-free between calibrations and is entirely selective for CO<sub>2</sub>. The sensor is built into the chamber and can be sterilized.

**O<sub>2</sub> control (chamber with O<sub>2</sub> control):** The CO<sub>2</sub> incubator is available with O<sub>2</sub> control in addition to CO<sub>2</sub> control. There are two different control ranges:

- Regular equipment: Hypoxic control range **0.2 to 20 vol. % O<sub>2</sub>**. Only N<sub>2</sub> can be connected to reduce O<sub>2</sub> concentration; it is not possible to connect O<sub>2</sub> gas bottles to increase O<sub>2</sub> concentration. Control in the low O<sub>2</sub> range is very precise, in particular in the range below 1 vol. % O<sub>2</sub>.
- Alternative control range **10 to 90 vol. % O<sub>2</sub>** (option). Although the high control range is intended in particular for hyperoxic applications (> 21 vol. % O<sub>2</sub>), it is also suitable for slightly hypoxic applications between 10 and 20 vol. % O<sub>2</sub>.

The O<sub>2</sub> sensor is a semiconductor gas sensor with ZrO<sub>2</sub> ceramic.



**CBF / CBF-UL humidity control:** The chamber is equipped with humidity control and a microprocessor-controlled humidification system.

Freshwater is supplied by manually filling a freshwater bag, which is placed behind the chamber door in a recess.

A resistance humidifying system humidifies the air. For this purpose, use deionized (demineralized) water. The option BINDER Pure Aqua Service allows using the chamber with any degree of water hardness.

**Controller:** The efficient program controller is equipped with a multitude of operating functions, in addition to recorder and alarm functions. Programming of test cycles is easily accomplished via the modern MB2 touch screen controller and is also possible directly with a computer via Intranet in connection with the APT-COM™ 4 Multi Management Software (option, chap. 18.1). The chambers are equipped with an Ethernet interface for computer communication. The APT-COM™ 4 Multi Management Software permits networking up to 30 chambers and connecting them to a PC for controlling and programming, as well as recording and representing temperature, CO<sub>2</sub> and O<sub>2</sub> and humidity data. For further options, see chap. 24.5.

	CB / CB-UL	CBF / CBF-UL
Temperature range:	4 °C / 7.2 °F above ambient temperature up to +60 °C / 140 °F	5 °C / 9 °F above ambient temperature up to +60 °C / 140 °F
Temperature range (chamber with O <sub>2</sub> control):	6 °C / 10.8 °F above ambient temperature up to +60 °C / 140 °F	7 °C / 12.6 °F above ambient temperature up to +60 °C / 140 °F
CO <sub>2</sub> range:	0 vol.-% up to 20 vol.-%	
O <sub>2</sub> range (chamber with O <sub>2</sub> control):	0.2 vol.-% up to 20 vol.-% (hypoxic control range) or 10 vol.-% up to 90 vol.-% (optional alternative control range)	
Humidity range (CBF / CBF-UL):	50 % r.h. up to 95 % r.h.	

## 2.1 Chamber overview

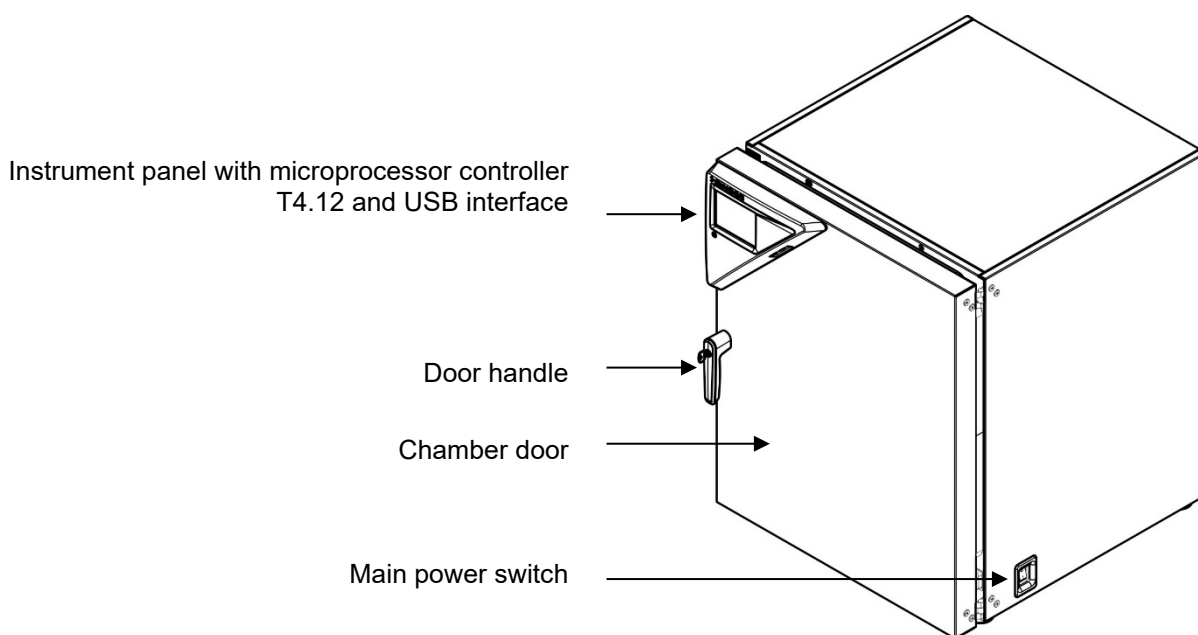

Figure 5: CO<sub>2</sub> incubator (example: model CB 170)

## 2.2 CB / CB UL inner chamber

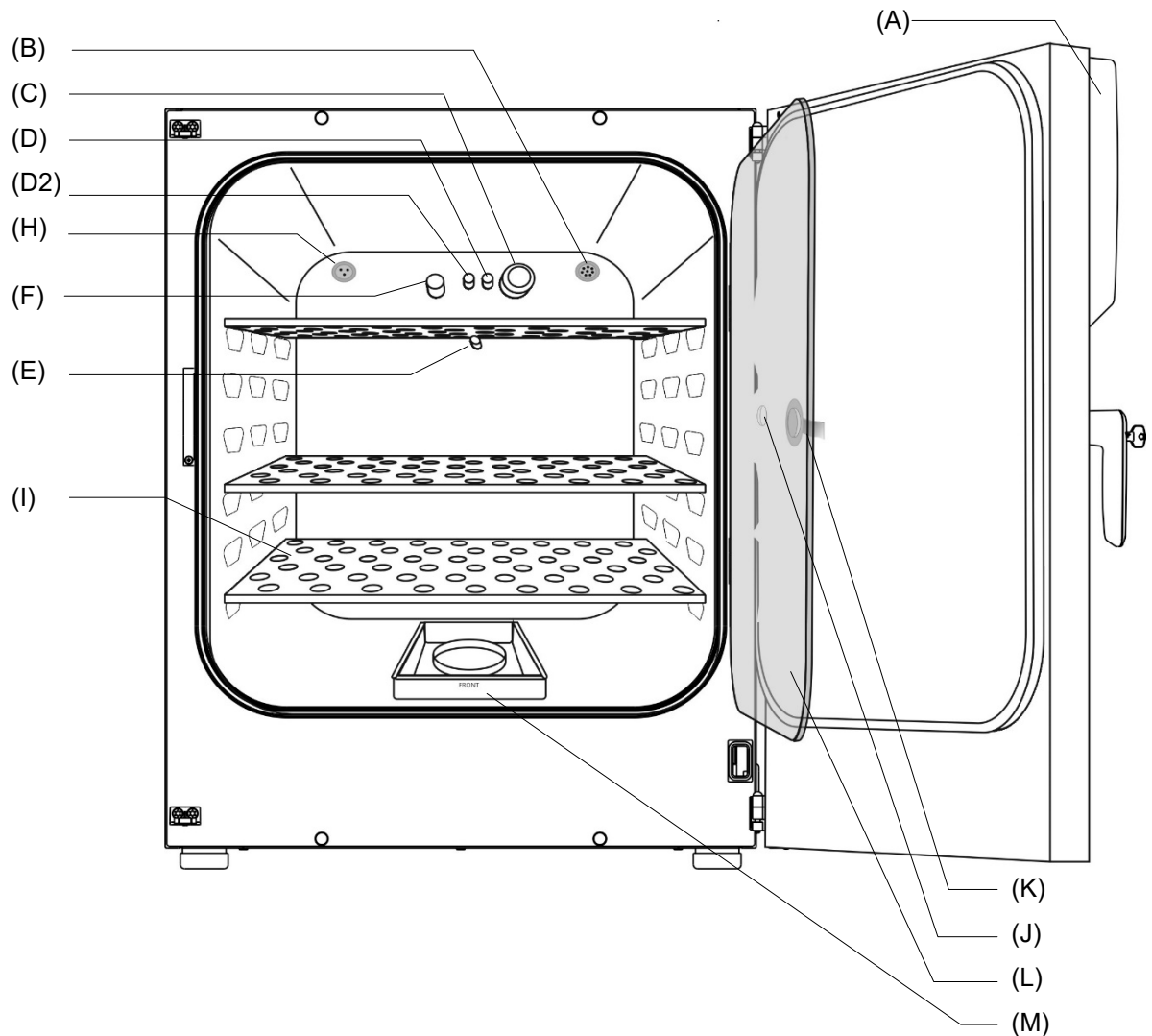

Figure 6: CB 170 with O<sub>2</sub> control and options

- (A) Instrument panel with microprocessor program controller MB2, indicating temperature, CO<sub>2</sub>, O<sub>2</sub> (chamber with O<sub>2</sub> control)
- (B) Connection socket for extra-low voltage supply (option, chap. 18.6)
- (C) CO<sub>2</sub> sensor
- (D) Gas mixing head CO<sub>2</sub>
- (D2) Additional gas mixing head O<sub>2</sub>/ N<sub>2</sub> (chamber with O<sub>2</sub> control)
- (E) Pt 100 temperature probe
- (F) O<sub>2</sub> sensor (chamber with O<sub>2</sub> control)
- (H) Internal socket 230V (max. 3 A) (option, available via BINDER INDIVIDUAL Customized Solutions, chap. 18.4)
- (I) Perforated shelves, made of stainless steel
- (J) Glass door handle
- (K) Measuring access port
- (L) Inner glass doors
- (M) Permady™ water pans

## 2.3 CBF / CBF UL inner chamber

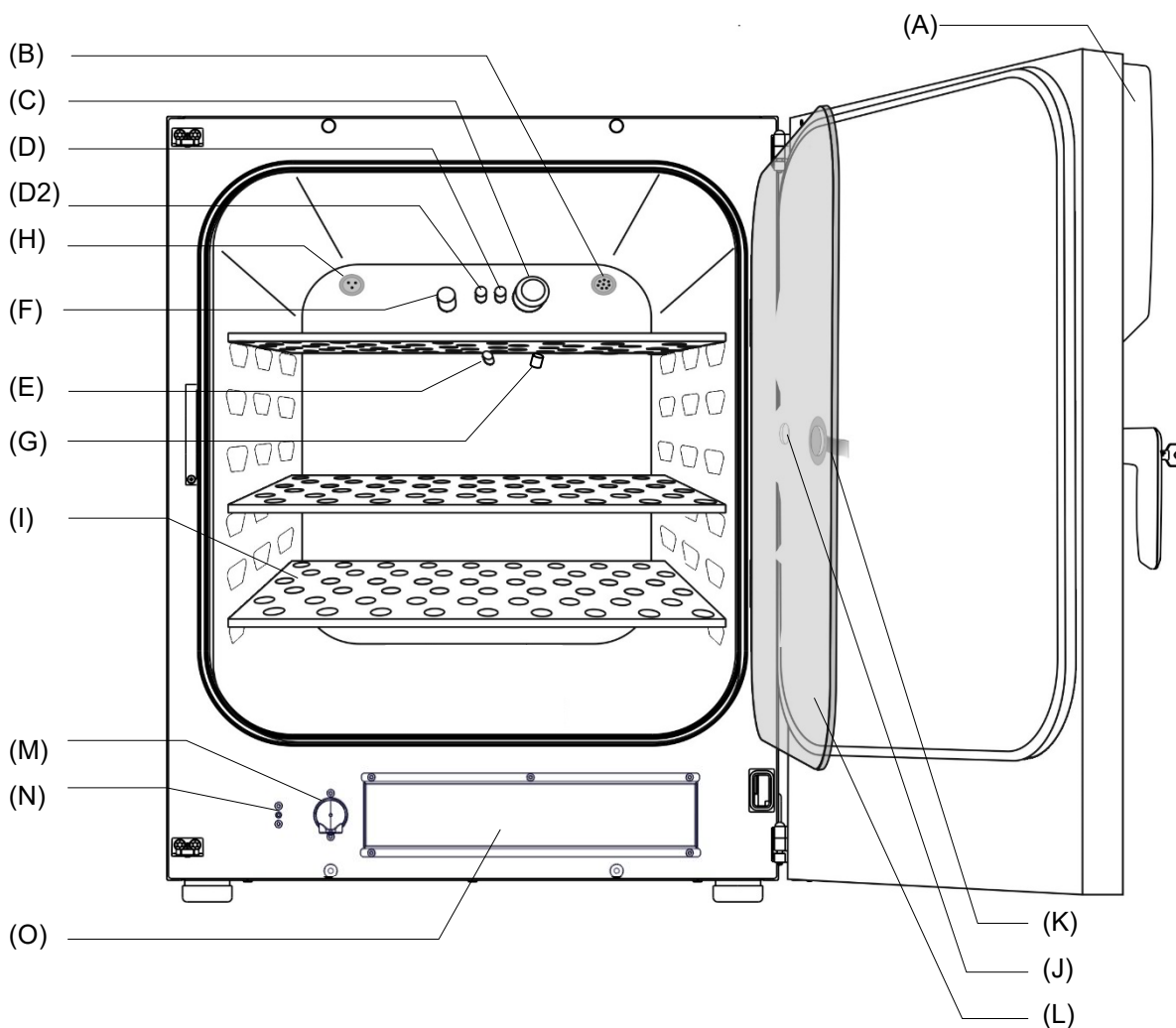

Figure 7: CBF 170 with O<sub>2</sub> control and options

- (A) Instrument panel with microprocessor program controller MB2, indicating temperature, CO<sub>2</sub>, O<sub>2</sub> (chamber with O<sub>2</sub> control) and humidity
- (B) Connection socket for extra-low voltage supply (option, chap. 18.6)
- (C) CO<sub>2</sub> sensor
- (D) Gas mixing head CO<sub>2</sub>
- (D2) Additional gas mixing head O<sub>2</sub>/ N<sub>2</sub> (chamber with O<sub>2</sub> control)
- (E) Pt 100 temperature probe
- (F) O<sub>2</sub> sensor (chamber with O<sub>2</sub> control)
- (G) Humidity sensor
- (H) Internal socket 230V (max. 3 A) (option, available via BINDER INDIVIDUAL Customized Solutions, chap. 18.4)
- (I) Perforated shelves
- (J) Glass door handle
- (K) Measuring access port
- (L) Inner glass door
- (M) Pump
- (N) Water connection for silicone tube
- (O) Opening for freshwater bag

## 2.4 Control panel on the rear of the chamber

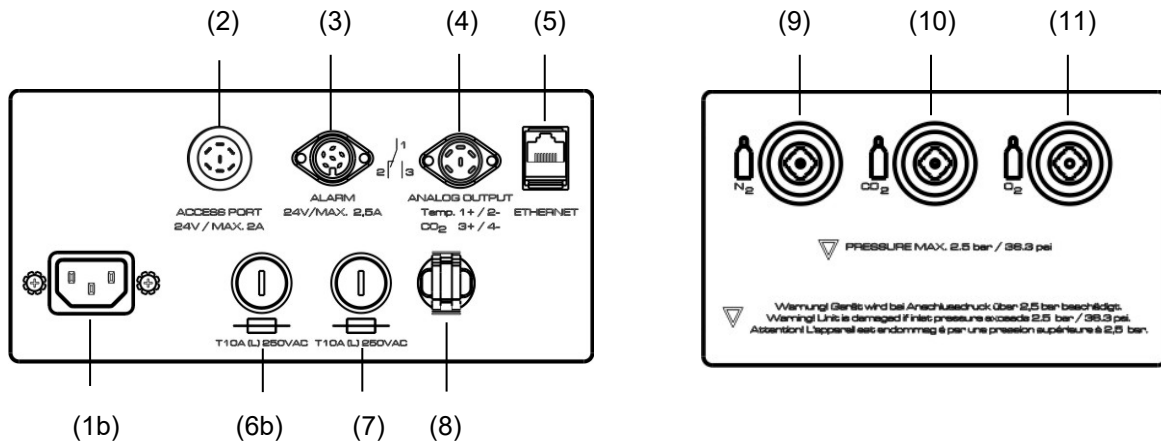

Figure 8: Rear control panel CB with O<sub>2</sub> control and options

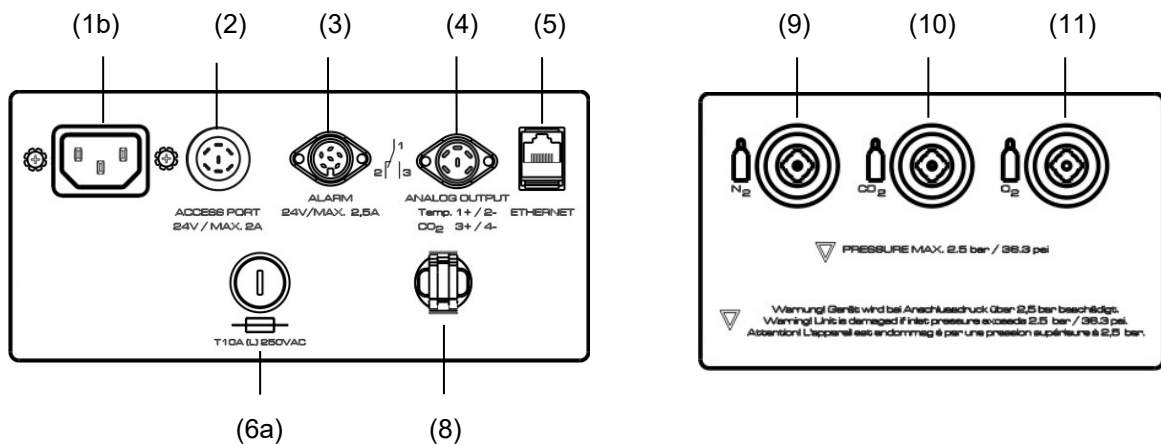
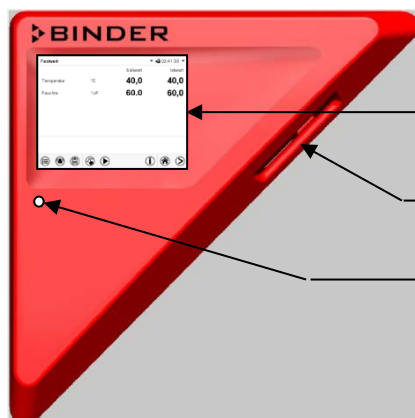

Figure 9: Rear control panel CB-UL with O<sub>2</sub> control and options

- (1a) Socket for IEC connector plug / power cable 100-120 V AC
- (1b) Socket for IEC connector plug / power cable 230 V AC
- (2) External socket for extra-low voltage supply (option for chamber size 170 / 260, chap. 18.6)
- (3) DIN-socket for zero-voltage relay alarm outputs
- (4) DIN socket for analog outputs 4-20 mA (option, chap. 18.5)
- (5) Ethernet interface for computer communication
- (6a) Miniature fuse T12,5 A (L) 250 V AV for 100-120 V chamber
- (6b) Miniature fuse T10 A (L) 250 V AC for 200-230 V chamber
- (7) Miniature fuse T10 A (L) 250 V AC for 200-230 V chamber
- (8) Strain relief for power cable
- (9) Quick acting closure socket for N<sub>2</sub> (chamber with O<sub>2</sub> control)
- (10) Quick acting closure socket for CO<sub>2</sub>
- (11) Quick acting closure socket for O<sub>2</sub> (chamber with O<sub>2</sub> control with optional alternative control range 10 up to 90 vol.-% O<sub>2</sub>)

## 2.5 Instrument panel



MB2 controller display  
5,7" with touchscreen

USB interface

Pilot lamp

Figure 10: Instrument panel with MB2 program controller and USB interface

## 3. Completeness of delivery, transportation, storage, and installation

### 3.1 Unpacking, and checking equipment and completeness of delivery

After unpacking, please check the chamber and its optional accessories, if any, based on the delivery receipt for completeness and for transportation damage. Inform the carrier immediately if transportation damage has occurred.

The final tests of the manufacturer may have caused traces of the shelves on the inner surfaces. This has no impact on the function and performance of the chamber.

Please remove any transportation protection devices and adhesives in/on the chamber and on the doors and remove the operating manuals and accessory equipment.



Remove any protective lamination sheet on the inner metal surfaces prior to commissioning.



**CAUTION**

**Risk of injury and damages by lifting heavy loads and by sliding or tilting of the chamber due to improper lifting.**

**Injuries, damage to the chamber.**

- ⊘ Do NOT lift or transport the chamber using the door handle or the door.
- Lift the chamber from the pallet at the four lower corners with the aid of four people.

If you need to return the chamber, please use the original packing and observe the guidelines for safe lifting and transportation (chap. 3.2).

For disposal of the transport packing, see chap. 23.1.



#### Note on second-hand chambers (Ex-Demo-Units):

Second-hand chambers are chambers that were used for a short time for tests or exhibitions. They are thoroughly tested before resale. BINDER ensures that the chamber is technically sound and will work flawlessly.

Second-hand chambers are marked with a sticker on the chamber door. Please remove the sticker before commissioning the chamber.

### 3.2 Guidelines for safe lifting and transportation

After operation, please observe the guidelines for temporary decommissioning (chap. 23.2). Empty the Permadyr™ water pan before moving the chamber (CB / CB-UL). In case of any spillage of the contents, shut down the chamber and dry it out carefully and completely (CB / CB-UL).

	 <b>CAUTION</b>
	<p><b>Risk of injury and damages by lifting heavy loads and by sliding or tilting of the chamber due to improper transportation.</b></p> <p><b>Injuries, damage to the chamber.</b></p> <ul style="list-style-type: none"> <li>➤ Transport the chamber in its original packaging only.</li> <li>➤ For moving or shipping, secure the chamber with transport straps.</li> <li>⊗ Do NOT lift or transport the chamber using the door handle or the door.</li> <li>➤ Lift the chamber at the four lower corners with the aid of 4 people and place it on a rolling pallet.</li> <li>➤ Move the chamber to the desired location and lift it from the rolling pallet with the aid of four people.</li> </ul>

- Permissible ambient temperature range during transport: 10 °C / 14 °F to +60 °C / 140 °F.

You can order transport packing for moving or shipping purposes from BINDER service.

**Permissible ambient temperature range during transport:**

- If the humidifying system has NOT been emptied: +3 °C / 37.4 °F to +60 °C / 140 °F.
- After emptying the humidifying system (after sterilization): -10 °C / 14 °F to +60 °C / 140 °F.

With temperatures below +3 °C / 37.4 °F, water must be completely removed from the humidifying system.

	<b>NOTICE</b>
	<p><b>Danger of freezing in the steam generator when transporting the chamber below +3 °C / 37.4 °F with filled steam humidifying system.</b></p> <p><b>Damage to the chamber.</b></p> <ul style="list-style-type: none"> <li>➤ Before any transportation below +3 °C / 37.4 °F, empty the freshwater bag to remove water from the humidifying system and perform a sterilization.</li> </ul>

### 3.3 Storage

Intermediate storage of the chamber is possible in a closed and dry room. Observe the guidelines for temporary decommissioning (chap. 23.2).

**Permissible ambient temperature range during storage:**

- If the humidifying system has NOT been emptied: +3 °C / 37.4 °F to +60 °C / 140 °F.
- After emptying the humidifying system (after sterilization): -10 °C / 14 °F to +60 °C / 140 °F

With temperatures below +3 °C / 37.4 °F, water must be completely removed from the humidifying system.

	<b>NOTICE</b>
	<p><b>Danger of freezing in the steam generator when storing the chamber below +3 °C / 37.4 °F with filled steam humidifying system.</b></p> <p><b>Damage to the chamber.</b></p> <ul style="list-style-type: none"> <li>➤ Before any storage below +3 °C / 37.4 °F, empty the freshwater bag to remove water from the humidifying system and perform a sterilization.</li> </ul>

- **Permissible ambient humidity:** max. 70 % r.h., non-condensing.

After extensive operation at humidity levels > 70% r.h., condensation from excessive humidity can lead to corrosion during storage. In this case the chamber must first be dried.

	NOTICE
	<p><b>Danger of corrosion on the housing due to condensation by excess humidity after operating at humidity values &gt; 70 % r.h. for a long period.</b></p> <p><b>Damage to the chamber.</b></p> <ul style="list-style-type: none"> <li>➤ Let the chamber dry for several days before shut-down:           <ul style="list-style-type: none"> <li>• CB / CB-UL: Empty the Permadyry water pan.</li> <li>• CBF / CBF-UL: Turn off humidity control (chap. 6.7).</li> <li>• Set the temperature set point to 60 °C / 140 °F for approx. 2 hours.</li> <li>• Only then, shut down the chamber at the main power switch (1) and empty the freshwater bag (CBF / CBF-UL).</li> </ul> </li> </ul>

When after storage in a cold location you transfer the chamber to its warmer installation site, condensation may form. Before start-up, wait at least one hour until the chamber has attained ambient temperature and is completely dry.

CBF / CBF-UL: In case of a prolonged temporal decommissioning: Leave the chamber door open or remove the optional access port plugs.

	NOTICE
	<p><b>Danger of condensation on the CO<sub>2</sub> sensor head following turning off the incubator. Error messages, chamber malfunction.</b></p> <ul style="list-style-type: none"> <li>➤ Each time the chamber is turned off at the main power switch: Pull off the filter cap of the CO<sub>2</sub> sensor and let it dry until no more condensation is visible. Put the filter cap back on.</li> <li>➤ For temporary decommissioning, open all doors, empty the water basin (CB / CB-UL) and allow the chamber to dry for at least 1 hour.</li> </ul>

### 3.4 Location of installation and ambient conditions

#### Notes on the location of installation

Set up the chamber on a flat, even surface, free from vibration and in a well-ventilated, dry location. The chambers are designed for setting up inside a building (indoor use).

Freestanding chamber are suitable for installation on tables or on the optionally available stand (height 200 mm / 0.5 ft). Note: The site of installation must be capable of supporting the chamber's weight (see technical data, chap.24.4).

Align the chamber using a spirit level to ensure even covering of the cell-cultures with the medium. For this purpose, manually adjust the four chamber feet.

The chambers can be stacked on top of each other (two chambers maximum). For safe stacking that is easy to maintain, use the original BINDER stacking stand (chap. 18.8.2) or the base on castors (chap. 18.8.3).



To completely separate the chamber from the power supply, you must disconnect the power plug. Install the chamber in a way that the power plug is easily accessible and can be easily pulled in case of danger.

For the user there is no risk of temporary overvoltages in the sense of EN 61010-1:2010.

In order to avoid contamination, never place the chamber directly on the floor.

	NOTICE
	<p><b>Danger of overheating due to lack of ventilation.</b>  <b>Damage to the chamber.</b></p> <ul style="list-style-type: none"> <li>⊘ Do NOT install the chamber in unventilated recesses.</li> <li>➤ Ensure sufficient ventilation for dispersal of the heat.</li> <li>➤ Observe the prescribed minimum distances when installing the chamber.</li> </ul>

Do not install or operate the chamber in potentially explosive areas.

	 <b>DANGER</b>
	<p><b>Danger of explosion due to combustible dusts or explosive mixtures in the vicinity of the chamber.</b>  <b>Serious injury or death from burns and / or explosion pressure.</b></p> <ul style="list-style-type: none"> <li>⊘ Do NOT operate the chamber in potentially explosive areas.</li> <li>➤ KEEP explosive dust or air-solvent mixtures AWAY from the vicinity of the chamber.</li> </ul>

#### Ambient conditions

- Permissible ambient temperature range for operation: +18 °C / 64.4 °F to +30 °C / 86 °F; CB 56: 20 °C / 68.0 °F to +30 °C / 86 °F

At elevated ambient temperature values, fluctuations in temperature and humidity may occur.

- Ideal ambient temperature: at least 7 °C / 12.6 °F below the intended working temperature. E.g., working temperature 37 °C / 98.6 °F = ambient temperature 30 °C / 86 °F and lower. In the event of working temperatures of less than 7 °C / 12.6 °F above the ambient temperature, the setpoint can be exceeded.

Do not place the chamber directly below the air outlet of an air conditioner.

	<p>The ambient temperature should not be substantially higher than the indicated ambient temperature of 22 +/-3 °C / 71.6 +/-5.4 °F to which the specified technical data relates. For other ambient conditions, deviations from the indicated data are possible.</p>
---	---

	<p>Avoid direct solar radiation on the chamber.          Avoid strong drafts, e.g. by air conditioning.</p>
---	---

- Permissible ambient humidity: 70 % r.h. max., non-condensing.
- Installation height: max. 2000 m / 6561.7 ft. above sea level

#### Minimum distances



- Wall distances: rear 100 mm / 3.94 in, sides 50 mm / 1.97 in.

	<p>To completely separate the chamber from the power supply, you must disconnect the power plug. Install the chamber in a way that the power plug is easily accessible and can be easily pulled in case of danger.</p>
---	--

#### Notes on handling carbon dioxide (CO<sub>2</sub>)

Carbon dioxide (CO<sub>2</sub>) in high concentrations is hazardous to health. It is colorless and almost odorless and therefore practically imperceptible. Vent out any CO<sub>2</sub> gas that may escape via good room ventilation or a suitable connection to an exhaust system. We recommend installing a CO<sub>2</sub> warning system.



	 <b>DANGER</b>
	<p><b>Danger of suffocation and poisoning by high concentration of CO<sub>2</sub> (&gt; 4 Vol.-%).</b>  <b>Death by suffocation.</b></p> <ul style="list-style-type: none"> <li>⊘ Do NOT set up chambers in non-ventilated recesses.</li> <li>➤ Ensure technical ventilation measures.</li> <li>➤ Observe the relevant regulations for handling CO<sub>2</sub>.</li> </ul>

Observe the **occupational exposure limit OEL** for CO<sub>2</sub> set by the national authorities (formerly maximum permitted workplace concentration). Check compliance when operating all chambers located in the room.

- OEL for Germany: 5000 ml/m<sup>3</sup> (ppm) = 0,5 Vol.-%
- CO<sub>2</sub> lost from incubator size 170 at 5 vol.-% CO<sub>2</sub> with each opening the door: about 14.8 g, i.e. 0.00758 cubic meters / *0.268 cubic feet* (under normal pressure)
- CO<sub>2</sub> lost during 12h at 5 vol.-% without opening the door: approx. < 2 g, i.e. 0.001 cubic meter / *0.035 cubic feet* (under normal pressure 1013 mbar / *14.7 psi*)

**An example of how to evaluate laboratory volume and air change rate:**

**Question:** Is an air change rate of 1/h sufficient for a lab with a volume of 100 cubic meters / *3,531.5 cubic feet* with 10 CO<sub>2</sub> incubators size 170, opened 4 times per hour?

**Calculation:** CO<sub>2</sub> concentration = CO<sub>2</sub> lost by opening the door, multiplied by 10 incubators, multiplied by opening the door 4 times per hour, divided by lab volume

0.00758 cubic meters x 10 x 4 div. 100 cubic meters = 0.003032, i.e. 0.303 % or 3032 ppm.



*0.2676852 cubic feet x 10 x 4 div. 3,531.467 cubic feet* = 0.003032, i.e. 0.303 % or 3032 ppm.

**Result:** The maximum permissible value of 5000 ppm is not exceeded under these operation conditions.

Even when CO<sub>2</sub> or systems operated with CO<sub>2</sub> are handled carefully and appropriately, a residual risk remains, which can lead to life-threatening situations under certain circumstances. Therefore we strongly recommend continuous monitoring of CO<sub>2</sub> concentration in the ambient air of the CO<sub>2</sub> incubator. It must be ensured permanently that the maximum permissible occupational exposure limit OEL for CO<sub>2</sub> (0.5 vol.-% CO<sub>2</sub> for Germany) is not exceeded.

**Chamber with O<sub>2</sub> control: Notes on handling oxygen (O<sub>2</sub>)**

Oxygen (O<sub>2</sub>) is colorless and almost odorless and therefore practically imperceptible. It promotes burns, which can proceed explosively. There is a fire hazard for flammable oxygenated materials, e.g. clothes and hair. O<sub>2</sub> is heavier than air and may accumulate in low-lying areas.

	 <b>DANGER</b>
	<p><b>Danger of fire and explosion through contact of combustible materials with O<sub>2</sub> with high concentration of O<sub>2</sub> (&gt; 21 % O<sub>2</sub>).</b>  <b>Serious injury or death from burns and / or explosion pressure.</b></p> <ul style="list-style-type: none"> <li>⊘ Do NOT set up chambers in non-ventilated recesses.</li> <li>➤ Ensure technical ventilation measures.</li> <li>➤ Observe the relevant regulations for handling O<sub>2</sub>.</li> </ul>

Take appropriate measures to prevent oxygen enrichment and fire and explosion hazards in areas where oxygen enrichment is possible.



General information for safe handling of oxygen:

- Make sure training of personnel on hazards of oxygen enrichment and necessary safety measures.
- Make sure adequate labeling of all oxygen equipment and facilities.
- Make sure gas tightness of all gas connections by checking them for leaks (e.g. with leak spray or diluted soap solution).
- Close the main valve of the source of oxygen after work when not using the chamber.
- Never lubricate O<sub>2</sub> equipment with oil or fat. Use only materials and spare parts which are approved for use with oxygen.
- Regularly inspect fire extinguishers for proper condition.
- Set up emergency showers where oxygen enrichment is possible.
- Strictest smoking ban and no ignition sources in areas where oxygen enrichment is possible.
- Make sure good ventilation of areas where oxygen enrichment is possible (location of the chamber and/or O<sub>2</sub> cylinders).
- Persons who may have been in a possibly oxygen-enriched atmosphere must keep away from ignition sources (flames, cigarettes, etc.) and ventilate their clothes at least 15 minutes.
- Always keep emergency routes free.

#### **Chamber with O<sub>2</sub> control: Notes on handling nitrogen (N<sub>2</sub>)**

Nitrogen (N<sub>2</sub>) in high concentrations is hazardous to health. It is colorless and almost odorless and therefore practically imperceptible. Any N<sub>2</sub> gas that may escape must be safely led out via good room ventilation or a suitable connection to an exhaust system.



**DANGER**

**Risk of suffocation through high concentration of N<sub>2</sub>.**

**Death by suffocation.**

- Ø Do NOT set up chambers in non-ventilated recesses.
- Ensure technical ventilation measures.
- Observe the relevant regulations for handling N<sub>2</sub>.

## **4. Installation and connections**

### **4.1 Shelves**

You can put the shelves in different positions at the line of channel beads in the inner chamber. Hold the shelf straight and then insert it so it will go smoothly inside the chamber.

#### **Permitted shelf loads:**

- Maximum load of one single shelf: 10 kg / 22 lb.
- Maximum total load of all shelves: Incubator size 56 / 170: 30 kg / 66 lb.  
Incubator size 260: 40 kg / 88 lb

## 4.2 Permady™ water pan (CB / CB-UL)

The Permady™ system developed by BINDER is an effective and easy to handle system that ensures high humidity inside the chamber without any condensation forming on the inner surfaces. The Permady™ water pan consists of two pans in which the outer one is heated and the inner one cooled. With the slight difference of temperature caused by that cooling, the central pan is the specific point for condensation of the surplus humidity. Therefore, all other inner surfaces remain dry.



Incubator size 56

Incubator size 170

Incubator size 260

Figure 11: Permady™ water pan

- Incubators size 56: Put the water pan in lengthwise direction on the bottom of the inner chamber between the notches in the chamber bottom. Incubators size 170 / 260: Put the Permady™ water pan on the bottom of the inner chamber in a way that both notches lock into place.
- Incubators size 170 / 260: The front side of the Permady™ water pan for incubators size 170 / 260 is marked "FRONT".



Figure 12: Letters "FRONT" indicating the front of the Permady™ water pan for incubators size 170 / 260

- Please make sure that the Permady™ water pan has firm contact to the inner chamber bottom and rests tightly on it (notches locked into place).
- Incubators size 56: Fill the pan with distilled, sterilized water up to the filling level marking on the inner edge. Maximum filling quantity: approx. 1.0 liters.
- Incubators size 170 / 260: Fill only the outer pan with distilled, sterilized water up to the filling level marking on the edge of the inner pan. Maximum filling quantity of the outer basin: incubator size 170: approx. 1.3 liters, incubator size 260: approx. 2.0 liters.



Figure 13: Incubators size 56,  
Filling height line of the pan



Figure 14: Incubators size 170 / 260,  
Filling height line of the outer basin

- We recommend cleaning and refilling the pans 2 to 3 times a week. For evacuation, remove the Permady™ water pan.
- We recommend using distilled, sterile water to achieve optimum growth results. Any corrosive damage that may arise following the use of water of different quality or by additives is excluded from the liability agreement.
- If required, you can add microbiologically inhibiting substances such as copper chips, copper sulfate or ethylene diamine tetra-vinegar acid (EDTA) in a concentration of 1 to 5 mmol/l.

Empty the Permadyr™ water pan before moving the chamber. In case of the contents spilling, immediately shut down the chamber and dry it carefully and completely.

### 4.3 Connecting the O<sub>2</sub> sensor (chamber with O<sub>2</sub> control)

The O<sub>2</sub> sensor is supplied with the chamber in a separate package.



Connect or remove the O<sub>2</sub> sensor only when the chamber is turned off.

Open the door of the inner chamber and plug the O<sub>2</sub> sensor (F) into the left connection socket located in the upper part of the rear of the inner chamber. Pay attention to the correct positioning of the pins.



Figure 15: O<sub>2</sub> sensor

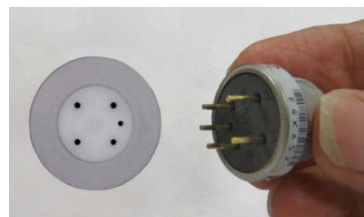

Figure 16: Connecting the O<sub>2</sub> sensor



The O<sub>2</sub> sensor must be plugged in during a hot-air sterilization.

### 4.4 Gas connections



General information for safe handling of gas cylinders:

- Store and use gas cylinders only in well ventilated areas.
- Open the gas cylinder valve slowly to avoid pressure surges.
- Secure gas cylinders during storage and use against falling (chaining).
- Transport gas cylinders with a cylinder cart, do not carry, roll, or throw them.
- Always close the valve even with apparently empty cylinders; screw on the cap when not in use. Return gas cylinders with the valve closed.
- Do not open gas cylinders by force. Mark them when damaged.
- Protect gas cylinders against fire, e.g. do not store together with flammable liquids.
- Observe relevant regulations for dealing with gas cylinders.

Secure the gas cylinders against falling and other mechanical damage.





#### WARNING

**Risk of injury through sudden release of the stored pressure energy when the valve safety is torn off.**

**Injuries.**

- Secure gas cylinders against falling (chaining).
- Transport gas cylinders with a cylinder cart.



The valve of the gas cylinder **always** must be closed before screwing on or unscrewing the gas hose.

	 <b>WARNING</b>
	<p><b>Risk of injury through sudden release of the stored pressure energy when opening the cylinder valve of a not connected cylinder.</b></p> <p><b>Injuries.</b></p> <ul style="list-style-type: none"> <li>➤ Close the gas cylinder valve before connecting or removing the gas hose.</li> </ul>

	<p>After connecting the gas cylinder, check all gas connections for leaks (e.g. with leak spray or diluted soap solution).</p>
---	--

#### 4.4.1 Connection of the CO<sub>2</sub> gas cylinder

Carbon dioxide (CO<sub>2</sub>) in high concentrations is hazardous to health. It is colorless and almost odorless and therefore practically imperceptible. Vent out any CO<sub>2</sub> gas that may escape via good room ventilation or a suitable connection to an exhaust system. We recommend installing a CO<sub>2</sub> warning system.

	 <b>DANGER</b>
	<p><b>Danger of suffocation and poisoning by high concentration of CO<sub>2</sub> (&gt; 4 Vol.-%).</b></p> <p><b>Death by suffocation.</b></p> <ul style="list-style-type: none"> <li>⊘ Do NOT set up chambers in non-ventilated recesses.</li> <li>➤ Ensure technical ventilation measures.</li> <li>➤ Observe the relevant regulations for handling CO<sub>2</sub>.</li> <li>➤ Close the CO<sub>2</sub> supply when decommissioning the chamber.</li> </ul>

	<p>The CO<sub>2</sub> gas necessary for operation must have a technical grade of 99.5 %.</p>
---	--

	<p>The gas connections must be established by qualified personnel who are trained in handling the respective gases and familiar with the required safety measures.</p>
---	--

The following steps are required:

#### Ensuring the correct CO<sub>2</sub> output pressure

	<p>A gas supply pressure above 2.5 bar / 36 <i>psi</i> will result in chamber damage.</p>
---	---

Use a pressure reducer and make sure to avoid any excessive outlet pressure when connecting the gas hose to the chamber.

The real outlet pressure of gas cylinders, sets of gas cylinders or central gas supplies am on the second manometer must **not** exceed 2.5 bar / 36 *psi*.

	NOTICE
	<p><b>Danger of damage by excessive outlet pressure &gt; 2.5 bar / 36 psi.</b></p> <p><b>Damage to the chamber.</b></p> <ul style="list-style-type: none"> <li>⊘ The outlet pressure must NOT exceed the indicated value of 2.5 bar / 36 psi.</li> <li>➤ Before connecting, check the outlet pressure on the pressure reducer of the cylinder.</li> <li>➤ Adjust the outlet pressure to 2.0 bar / 29 psi above the ambient pressure.</li> </ul>

Observe the correct outlet pressure also when replacing the gas cylinders.

#### Establishing the connection to the chamber

Connect the supplied gas hose (internal diameter 6 mm / 0.24 inches) to the pressure reducer of the gas cylinders or central gas supply and secure the connection with the supplied hose clamp.

Connect the pre-assembled hose nozzle of the gas hose to the quick acting closure socket (10) DN 6 on the chamber rear, as described in chap. 4.4.4.

#### Leak test

After connecting the gas cylinder, check all gas connections for leaks (e.g. with leak spray or diluted soap solution).



	<p>The recovery times of the gas concentrations inside the chamber after opening the door are indicated in the technical data (chap. 24.4) and refer to a connection pressure of 2.0 bar / 29 psi. Decreasing supply pressure will result in longer recovery times.</p>
---	---

Conversion table for gas inlet pressures, bar – psi, see chap. 24.8.

#### 4.4.2 Connection of the O<sub>2</sub> gas cylinder (chamber with O<sub>2</sub> control with optional alternative control range 10 up to 90 vol.-% O<sub>2</sub>)

	<p>Note: Do not connect the O<sub>2</sub> cylinder or disconnect the gas supply (by pulling off the gas hose) when operating at setpoints below 19 vol.-% O<sub>2</sub>.</p>
---	--

Oxygen (O<sub>2</sub>) is colorless and almost odorless and therefore practically imperceptible. It promotes burns, which can proceed explosively. There is a fire hazard for flammable oxygenated materials, e.g. clothes and hair. O<sub>2</sub> is heavier than air and may accumulate in low-lying areas.

	 <b>DANGER</b>
	<p><b>Danger of fire and explosion through contact of combustible materials with O<sub>2</sub> with high concentration of O<sub>2</sub> (&gt; 21 % O<sub>2</sub>).</b></p> <p><b>Serious injury or death from burns and / or explosion pressure.</b></p> <ul style="list-style-type: none"> <li>⊘ Do NOT set up chambers in non-ventilated recesses.</li> <li>➤ Ensure technical ventilation measures.</li> <li>➤ Observe the relevant regulations for handling O<sub>2</sub>.</li> <li>➤ Close the O<sub>2</sub> supply when decommissioning the chamber.</li> </ul>

	<p>The O<sub>2</sub> gas necessary for operation must have a technical grade of 99.5 %.</p>
---	---

	<p>The gas connections must be established by qualified personnel who are trained in handling the respective gases and familiar with the required safety measures.</p>
---	--

The following steps are required:

### Ensuring the correct O<sub>2</sub> output pressure



A gas supply pressure above 2.5 bar / 36 psi will result in chamber damage.

Use a pressure reducer and make sure to avoid any excessive outlet pressure when connecting the gas hose to the chamber.

The real outlet pressure of gas cylinders, sets of gas cylinders or central gas supplies am on the second manometer must **not** exceed 2.5 bar / 36 psi.



### NOTICE

**Danger of damage by excessive outlet pressure > 2.5 bar / 36 psi.  
Damage to the chamber.**

- ∅ The outlet pressure must NOT exceed the indicated value of 2.5 bar / 36 psi.
- Before connecting, check the outlet pressure on the pressure reducer of the cylinder.
- Adjust the pressure to 2.0 bar / 29 psi above the ambient pressure.

Observe the correct outlet pressure also when replacing the gas cylinders.

### Establishing the connection to the chamber

Connect the supplied gas hose (internal diameter 6 mm / 0.24 inches) to the pressure reducer of the gas cylinders or central gas supply and secure the connection with the supplied hose clamp.

Connect the pre-assembled hose nozzle of the gas hose to the quick acting closure socket (11) DN 6 on the chamber rear, as described in chap. 4.4.4.

### Leak test

After connecting the gas cylinder, check all gas connections for leaks (e.g. with leak spray or diluted soap solution).



The recovery times of the gas concentrations inside the chamber after opening the door are indicated in the technical data (chap. 24.4) and refer to a connection pressure of 2.0 bar / 29 psi. Decreasing supply pressure will result in longer recovery times.

**Conversion table for gas inlet pressures, bar – psi, see chap. 24.8.**

### 4.4.3 Connection of the N<sub>2</sub> gas cylinder (chamber with O<sub>2</sub> control)

Nitrogen (N<sub>2</sub>) in high concentrations is hazardous to health. It is colorless and almost odorless and therefore practically imperceptible. Any N<sub>2</sub> gas that may escape must be safely led out via good room ventilation or a suitable connection to an exhaust system.



### DANGER

**Risk of suffocation through high concentration of N<sub>2</sub>.**

**Death by suffocation.**

- ∅ Do NOT set up chambers in non-ventilated recesses.
- Ensure technical ventilation measures.
- Observe the relevant regulations for handling N<sub>2</sub>.
- Close the N<sub>2</sub> supply when decommissioning the chamber.



The N<sub>2</sub> gas necessary for operation must have a technical grade of 99.5 %.



The gas connections must be established by qualified personnel who are trained in handling the respective gases and familiar with the required safety measures.

The following steps are required:

#### Ensuring the correct N<sub>2</sub> output pressure



A gas supply pressure above 2.5 bar / 36 *psi* will result in chamber damage.

Use a pressure reducer and make sure to avoid any excessive outlet pressure when connecting the gas hose to the chamber.

The real outlet pressure of gas cylinders, sets of gas cylinders or central gas supplies am on the second manometer must **not** exceed 2.5 bar / 36 *psi*.



#### NOTICE

**Danger of damage by excessive outlet pressure > 2.5 bar / 36 *psi*.**

**Damage to the chamber.**

- ∅ The outlet pressure must NOT exceed the indicated value of 2.5 bar / 36 *psi*.
- Before connecting, check the outlet pressure on the pressure reducer of the cylinder.
- Adjust the pressure to 2.0 bar / 29 *psi* above the ambient pressure.

Observe the correct outlet pressure also when replacing the gas cylinders.

#### Establishing the connection to the chamber

Connect the supplied gas hose (internal diameter 6 mm / 0.24 *inches*) to the pressure reducer of the gas cylinders or central gas supply and secure the connection with the supplied hose clamp.

Connect the pre-assembled hose nozzle of the gas hose to the quick acting closure socket (9) DN 6 on the chamber rear, as described in chap. 4.4.4.

#### Leak test

After connecting the gas cylinder, check all gas connections for leaks (e.g. with leak spray or diluted soap solution).



The recovery times of the gas concentrations inside the chamber after opening the door are indicated in the technical data (chap. 24.4) and refer to a connection pressure of 2.0 bar / 29 *psi*. Decreasing supply pressure will result in longer recovery times.



Conversion table for gas inlet pressures, bar – psi, see chap. 24.8.

#### 4.4.4 Connecting the gas hose to the chamber rear (for CO<sub>2</sub>, O<sub>2</sub>, N<sub>2</sub>)

The procedure of connecting the gas hose to the chamber rear is the same for any gas connection. All quick acting closure sockets (CO<sub>2</sub>, N<sub>2</sub> with O<sub>2</sub> control, and O<sub>2</sub> with O<sub>2</sub> control and optional alternative control range 10 up to 90 vol.-% O<sub>2</sub>) are degreased and supplied with a FKM gasket.



**Note for chambers with O<sub>2</sub> control:** The quick acting closure socket and the hose nozzle for the O<sub>2</sub> connection must be degreased.

	 <b>DANGER</b>
<p><b>Fire and explosion hazard through contact of fat with O<sub>2</sub>.</b>  <b>Serious injury or death from burns and / or explosion pressure.</b>          ∅ All connection parts for the O<sub>2</sub> connection must be degreased.</p>	

The gas hose, which will be used to establish the connection to a gas cylinder, is already attached to the hose nozzle and secured by a hose clamp. Plug the hose nozzle into the corresponding quick acting closure socket (a) located at the rear of the chamber. This quick acting closure socket is closed by a rubber cover (b).

	<p>Only use the supplied hose nozzle to connect to the quick acting closure socket. Otherwise, the quick acting closure socket may leak, and/or it may become impossible to connect the original hose nozzle. In this case, please contact BINDER Service.</p>
---	--

Remove the rubber cover (b) by pulling it off.

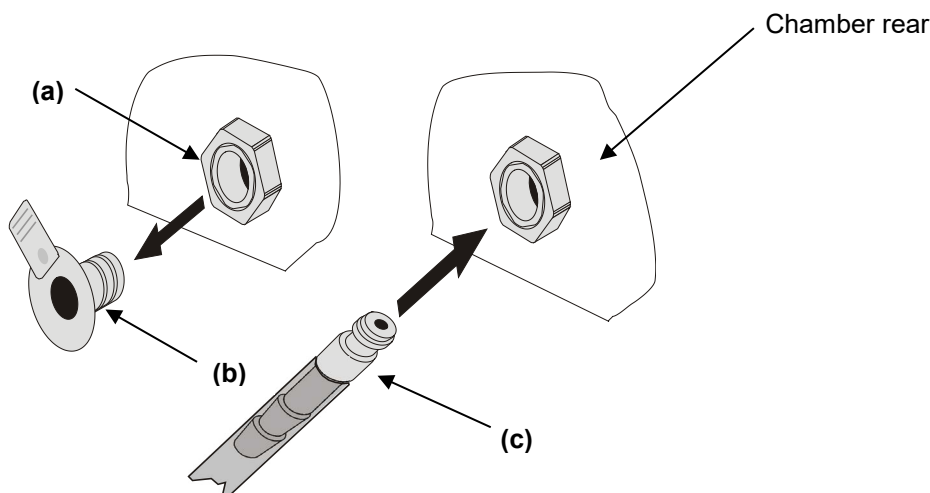
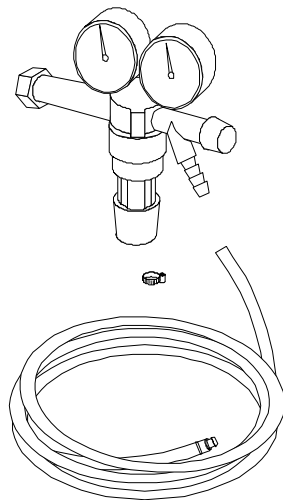

Figure 17: Connecting the hose lead to the gas cylinder

Now fit the hose nozzle (c) in the quick acting closure socket. To remove the connection, pull the hose nozzle off the quick acting closure socket.

#### 4.4.5 Gas cylinder connection kits (option)





Gas cylinder connection kits are available for CO<sub>2</sub> (Art. No. 8012-0014), O<sub>2</sub> (Art. No. 8012-0015) and N<sub>2</sub> (Art. No. 8012-0016).

The connection kit includes the following parts for connecting a gas cylinder to the CO<sub>2</sub> incubator:

- Pressure reducer with manometers for cylinder pressure (high pressure gauge) and outlet pressure (low pressure gauge)
- 5 m pressure hose with pre-assembled hose nozzle for quick acting closure socket
- 1 hose clamp to connect the gas hose to the pressure reducer

Figure 18: Gas cylinder connection kit

	<b>NOTICE</b>
	<p><b>Danger of damage by excessive outlet pressure &gt; 2.5 bar / 36 psi.</b>  <b>Damage to the chamber.</b></p> <ul style="list-style-type: none"> <li>⊘ The outlet pressure must NOT exceed the indicated value of 2.5 bar / 36 psi.</li> <li>➤ Before connecting, check the outlet pressure on the pressure reducer of the cylinder.</li> <li>➤ Adjust the outlet pressure to 2.0 bar / 29 psi above the ambient pressure.</li> </ul>
	<p>The gas connections must be established by qualified personnel who are trained in handling the respective gases and familiar with the required safety measures.</p>

## 4.5 CBF / CBF-UL: Water supply and dehumidification

### 4.5.1 General remarks on water supply

#### 4.5.1.1 Water supply

Freshwater is supplied by manually filling a freshwater bag (tubular bag set, standard, can be reordered) or a freshwater can (optional water container set). It is also possible to connect prefilled water bottles (optional humidification water set). It is not possible to connect the chamber directly to a water pipe.

The freshwater bag has a volume of 0.9 liters / 0.32 cu.ft. and is placed behind the chamber door in a recess.

	<p>To guarantee humidification during 24 hours even at high humidity set-points and / or frequent door openings, we recommend checking the freshwater bag daily at the end of the day.</p>
---	--

When the freshwater can is empty, the message “Freshwater supply” will be displayed on the controller, the buzzer sounds, and the humidification module turns off. After acknowledging the alarm, the humidification module tries to fill up and start operating.

Water consumption at 37 °C / 98.6 °F and 93 % r.h.:

- Without opening the door: very low.
- When opening the door 10 times a day: approx. 70 ml per day.

#### 4.5.1.2 Dehumidification

To reduce the humidity, ambient air is sucked in through a gas fine filter (sterile filter). As a result, the air in the interior is diluted with the air from outside. The air tube for inlet of the ambient air is located in the upper right corner in the recess for the freshwater bag. We recommend replacing the sterile filter on this tube about once a month. To replace the sterile filter, see chap. 22.2.3.

#### 4.5.1.3 Types of suitable water quality

- Deionized water from a water treatment installation already existing at the customer's site. Conductivity from 1 µS/cm up to a maximum of 20 µS/cm. (Water, which is in equilibrium with the CO<sub>2</sub> in the air, and has a conductivity below 1 µS/cm (ultrapure water), may cause acid corrosion due to its low pH).
- Tap water that has been treated by the optional water treatment system BINDER Pure Aqua Service (disposable system). A reusable measuring equipment to assess the water quality is included (chap. 4.5.1.4).

	<p>BINDER GmbH is NOT responsible for the water quality at the user's site. Any problems and malfunctions that might arise following use of water of deviating quality is excluded from liability by BINDER GmbH. The warranty becomes void in the event of use of water of deviating quality.</p>
--	--

	<b>NOTICE</b>
	<p><b>Danger of calcification of the humidifying system.</b> <b>Damage to the chamber.</b> ➤ Operate the chamber with deionized (demineralized) water only.</p>

	<p>Water intake temperature NOT below +5 °C / 41 °F and not exceeding 40 °C / 104 °F.</p>
---	---

#### 4.5.1.4 BINDER Pure Aqua Service (option)

The optional BINDER water treatment system (disposable system) is available to treat tap water. The lifetime depends on water quality and the amount of treated water used. The measuring equipment to assess the water quality is reusable.

	<p>For detailed information on operating the water treatment system BINDER Pure Aqua Service and its function, please refer to the operating manual supplied with BINDER Pure Aqua Service.</p>
---	---

## 4.5.2 Water supply via freshwater bag (standard)

### 4.5.2.1 Scope of delivery

The optional tubular bag set includes all necessary connecting parts:

- Set art. no. 8009-1083 with 3 freshwater bags (included in scope of delivery)
- Set art. no. 8009-1058 with 12 freshwater bags (option, annual demand)

Each bag set includes:

- 3 resp. 12 (optional kit) freshwater bags (art.no. 6002-0626)
- 3 two-piece tube connectors with 3-5mm nozzles (art.no. 6009-0322)
- 3 two-piece tube connectors with 5-7mm nozzles (art.no. 6009-0323)
- 3 resp. 12 (optional kit) gas fine filters (sterile filter) (art.no. 6014-0012)
- 6 m silicone tube (DN 3mm) (art.no. 6008-0267)
- 1m filling tube (DN 10 mm) (art.no. 6008-0268)
- Instructions (art.no. 7001-0385)

### 4.5.2.2 Installation and connection of the freshwater bag (CBF / CBF-UL)

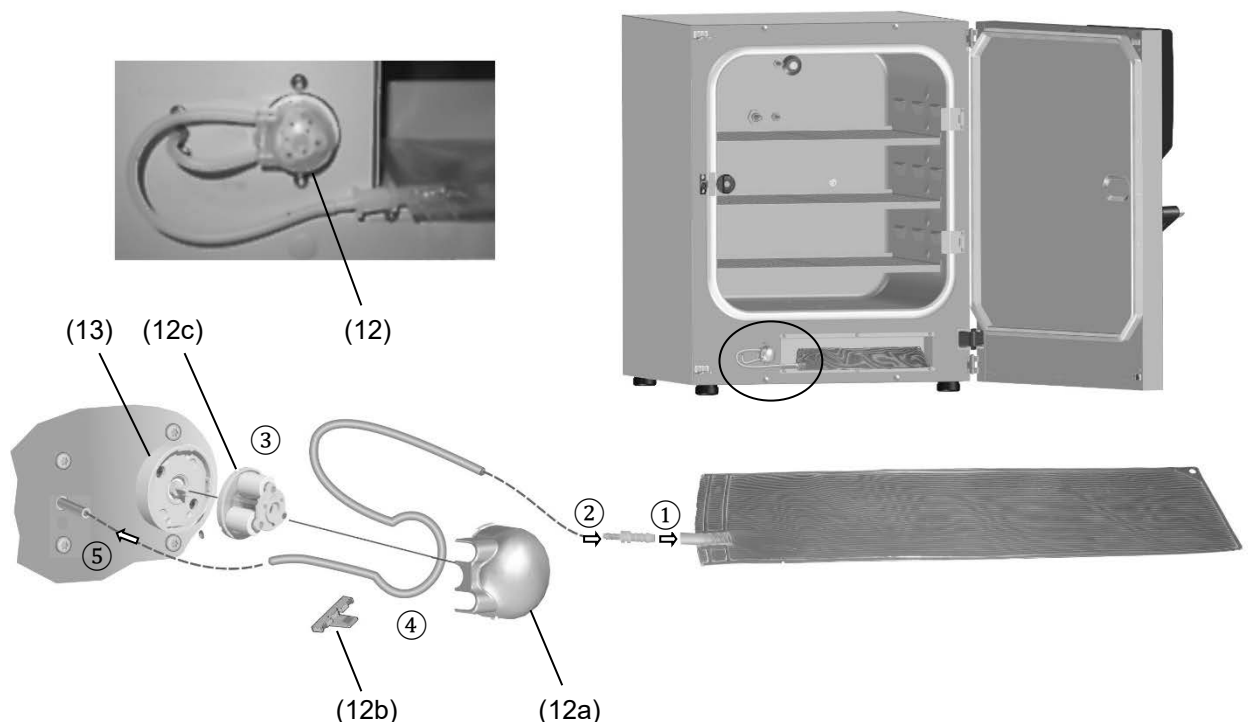

Figure 19: Installation of the water supply via freshwater bag

(12) Pump head

(12a) Pump head cover

(12b) Tube retainer

(12c) Rotor

(13) Pump connector

Please proceed in the following order:

- Fill the freshwater bag. Observe water quality and temperature (chap. 4.5.1.3).
- Attach a tube connector part with a 5-7 mm nozzle to the freshwater bag ①
- Attach a tube connector part with a 3-5 mm nozzle to the silicone tube ②
- Connect both tube connector parts
- Turn the pump head (12) counterclockwise until it stops and remove it from the pump connector (13).
- Pull up the tongue of the tube retainer (12b) up to “Click” and remove it. Take the rotor (12c) out of the pump head cover (12a). ③
- Lead the silicone tube along the rotor. Insert the rotor with the tube into the pump head cover. Keep the hose tight and do not pinch it. ④

The end of the tube for connecting to the incubator should be about 6 cm long. With a total length of the silicone tube of 32 cm, the tube end for connecting the freshwater bag has a length of approx. 18 cm

- Press the tube retainer (12b) into the pump head cover until it snaps into place

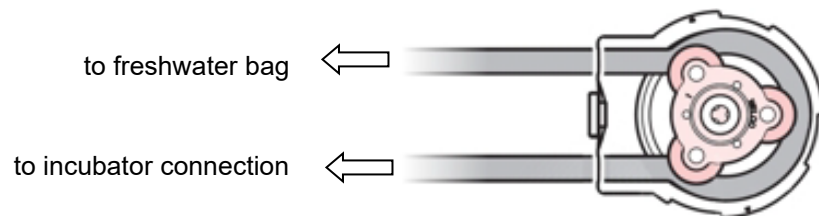

Figure 20: Inserting the silicone tube into the pump head ④

- Insert the pump head (12) into the pump connector (13) and turn it clockwise until it snaps into place.
- Attach the silicone tube to the incubator connection ⑤
- Place the freshwater bag with the opening to the left in the recess behind the chamber door.

#### 4.5.2.3 Refilling the already installed freshwater bag



For easier handling, you can temporarily release the pump head from the pump connector on the incubator.

##### Standard procedure

- Remove the connection between the both parts of the tube connector ①.
- Depending on the diameter of the object used for filling (hose, spray bottle ...), you may remove the connection between the hose connector part and the freshwater bag ①.
- Fill the freshwater bag. Observe water quality and temperature (chap. 4.5.1.3).
- If it has been removed, put the tube connector part with a 5-7 mm nozzle back on the freshwater bag ①
- Reassemble the two parts of the tube connector ①.

### Procedure with optional filling hose

A **bag set** (Art.no. 8009-1058) incl. accessories (annual demand) is optionally available (chap. 4.5.2). For easier filling, the set contains a filling tube (DN 10 mm) of 1 m length with a fitting tube connector.

- Remove the connection between both parts of the tube connector ①
- Attach the filling tube to the tube connector part which is still on the freshwater bag
- Fill the freshwater bag. Observe water quality and temperature (chap. 4.5.1.3).
- Remove the filling tube from the tube connector on the freshwater bag
- Reassemble the two parts of the tube connector ①.

### 4.5.2.4 Replacing the tube connectors for freshwater supply

3 two-piece tube connectors with 3-5mm nozzles und 3 two-piece tube connectors with 5-7mm nozzles are included with the optional bag set.

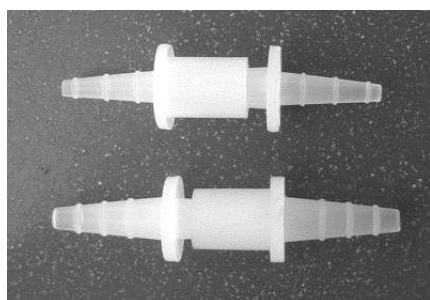

State of delivery:



Two-piece tube connector with 3-5mm nozzles

Two-piece tube connector with 5-7mm nozzles

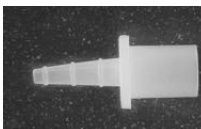
For connection to the silicone tube and the freshwater bag, the hose connectors must be combined accordingly:

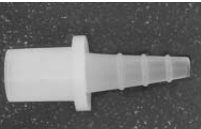
To silicone tube: 3-5 mm nozzle		To freshwater bag: 5-7 mm nozzle	
<b>Combination 1:</b>	Opening NW 7 mm		 Opening NW 4 mm
<b>Combination 2: (recommended)</b>	Opening NW 4 mm		 Opening NW 7 mm

### Connecting the freshwater bag

Put the filled freshwater bag on the nozzle of the hose connector.



### 4.5.3 Water supply via prefilled water bottle (optional humidification water set)

By using the humidification water set you will achieve unsurpassed contamination safety of your samples in the BINDER CO<sub>2</sub> incubator CBF / CBF-UL.

#### 4.5.3.1 Scope of delivery

The optional humidification water set includes all necessary connecting parts:

- Art.no. 8009-1104 Set with 10 prefilled one-liter bottles (annual demand)

The humidification water set includes:

- 10 one-liter bottles, prefilled with sterile, deionized water (art.no. 1007-0314)
- 3 spike connectors (transfer sets) for sterile liquids (art.no. 6007-0131)
- 3 two-piece tube connectors with 3-5mm nozzles (art.no. 6009-0322)
- 2 m silicone tube (DN 3mm) (art.no. 6008-0267)
- 3 gas fine filters (sterile filter) (art.no. 6014-0012)
- 20 cm silicone tube (DN 6 mm) (art.no. 6008-0009)
- Instructions (art.no. 7001-0385)

#### 4.5.3.2 Installation, connection and change of the prefilled water bottle

The optional humidification water set includes all necessary connecting parts.

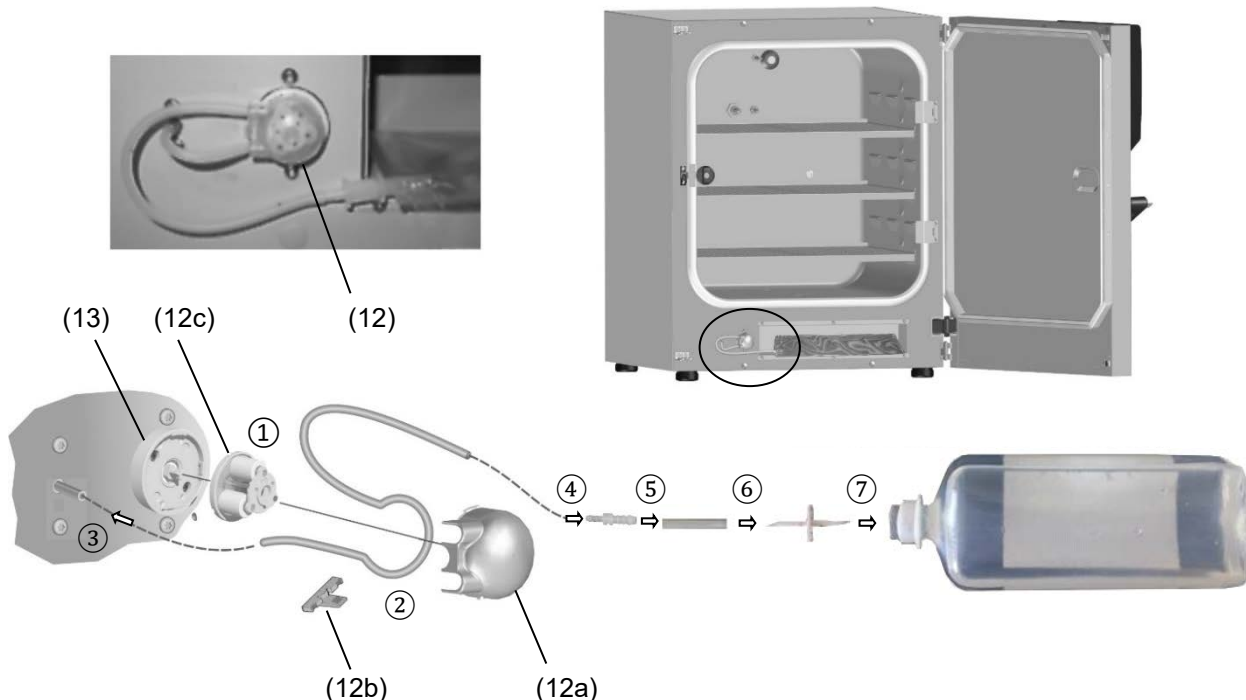

Figure 21: Installation of the water supply via prefilled water bottle

- |                       |                     |
|-----------------------|---------------------|
| (12) Pump head        | (12c) Rotor         |
| (12a) Pump head cover | (13) Pump connector |
| (12b) Tube retainer   |                     |

Please proceed in the following order:

- Turn the pump head (12) counterclockwise until it stops and remove it from the pump connector (13).
- Pull up the tongue of the tube retainer (12b) up to “Click” and remove it. Take the rotor (12c) out of the pump head cover (12a). ①
- Lead the silicone tube along the rotor. Insert the rotor with the tube into the pump head cover. Keep the hose tight and do not pinch it. ②

The end of the tube for connecting to the incubator should be about 6 cm long. With a total length of the silicone tube of 32 cm, the tube end for connecting the water bottle has a length of approx. 18 cm

- Press the tube retainer (12b) into the pump head cover until it snaps into place.

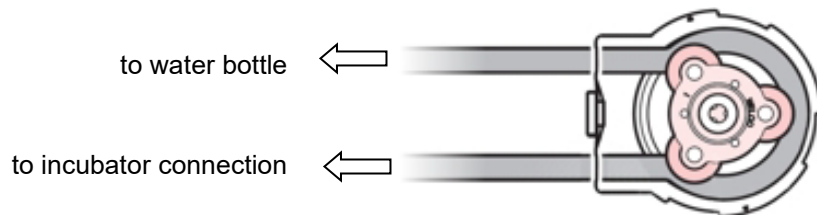
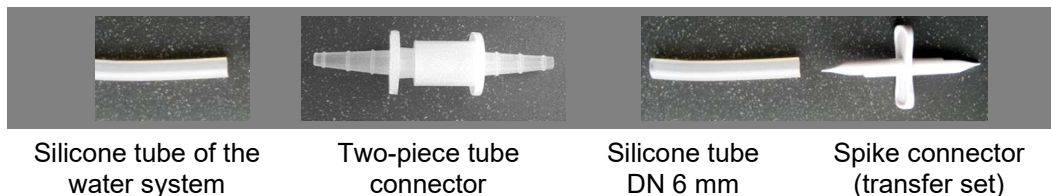
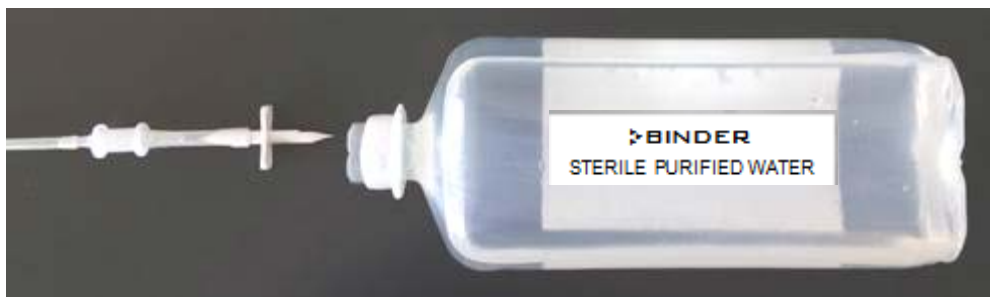

Figure 22: Inserting the silicone tube into the pump head ②

- Insert the pump head (12) into the pump connector (13) and turn it clockwise until it snaps into place.
- Attach the silicone tube to the incubator connection. ③
- Plug the part of the tube connector with 3-5mm nozzle in the silicon tube. ④
- Connect the free nozzle of the tube connector with a part of the silicon tube DN 6 mm ⑤
- Remove the protective cap of the spike connector (transfer set) and connect the nozzle of the tube connector with the spike connectors using a part of the DN 6 mm silicone tube. ⑥



- Then remove the second protective cap of the spike connector and insert the piercing pin into the water bottle through the silicone seal. ⑦





#### 4.5.4 Water supply via freshwater can (optional water container set)

The fresh water can, which is placed in an included magnetic can holder on the left chamber side, serves to supply one or several chambers with freshwater for humidification.

Since the pump is self-priming, it is not required that the water outlet of the can should be placed higher than the pump, so you can position the water can freely in height.

The freshwater can outlet must NOT be placed on or above the rear panel of the chamber or on the right chamber side.



	 <b>DANGER</b>
	<p><b>Electrical hazard by water entering the chamber via the rear panel. Deadly electric shock.</b></p> <ul style="list-style-type: none"> <li>➤ The magnetic support adjustable in height (option) may only be attached on the left side of the chamber.</li> <li>⊘ Do NOT place the freshwater can tap on or above the rear panel of the chamber</li> </ul>



Figure 23: Two CBF / CBF-UL incubators with installed water supply via freshwater can (option)

#### 4.5.4.1 Scope of delivery

The optional water container set includes all necessary connecting parts:

- Art. no. 8009-1128 Set with freshwater can, magnetic support and connecting parts

The water container set includes:

- Magnetic can holder adjustable in height, consisting of magnetic holder (art.no. 8022-0009) and water can support (art.no. 4021-0724)
- Water can, 10 l (art.no. 6011-0192)
- Hose coupling with aqua stop (art.no. 6002-0637)
- Angular coupling plug with aqua stop (art.no. 6002-0638)
- 12 gas fine filters (sterile filter) (art.no. 6014-0012)
- 10 m silicone tube (DN 3mm) (art.no. 6008-0267) to the pump or via T-type tube connectors to further chambers
- 50 cm silicone tube, d10 x 2 (art.no. 6008-0268)
- Reducing connector (tube connector 4/9 mm) (art.no. 6009-0308)
- 4 wire tension clamps (art.no. 6009-0281) (2 spare parts)
- 3 T-type tube connectors (T-Pieces), 4mm (art.no. 6009-0318)
- Instructions (art.no. 7001-0385)

#### 4.5.4.2 Installation and connection of the freshwater can (optional water container set)

The optional water container set includes all necessary connecting parts.

First, the silicone hose DN 3mm (24) must be connected to the chamber and led through the pump

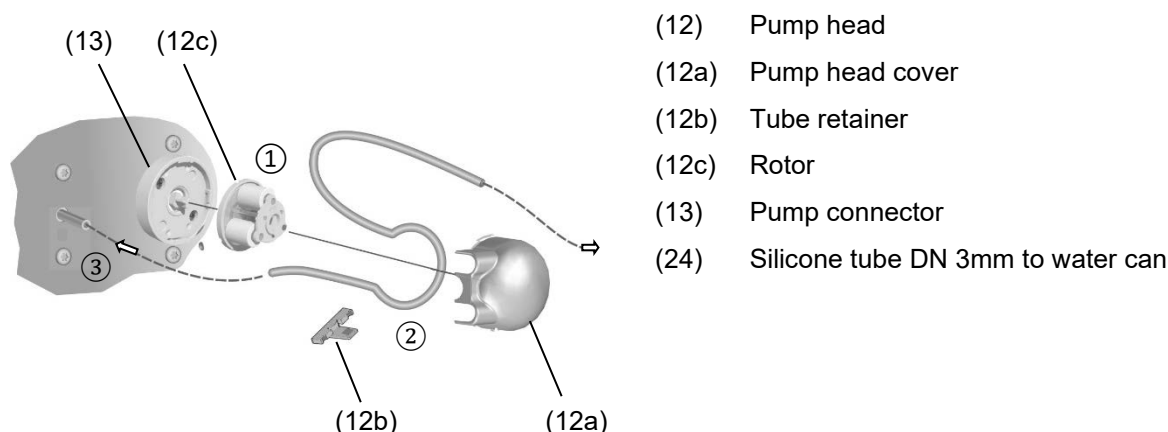

Figure 24: Installation of the water supply at the pump

Please proceed in the following order:

- Turn the pump head (12) counterclockwise until it stops and remove it from the pump connector (13).
- Pull up the tongue of the tube retainer (12b) up to “Click” and remove it. Take the rotor (12c) out of the pump head cover (12a). ①
- Lead the silicone tube along the rotor. Insert the rotor with the tube into the pump head cover. Keep the hose tight and do not pinch it. ②

The end of the tube for connecting to the incubator should be about 6 cm long.

- Press the tube retainer (12b) into the pump head cover until it snaps into place.

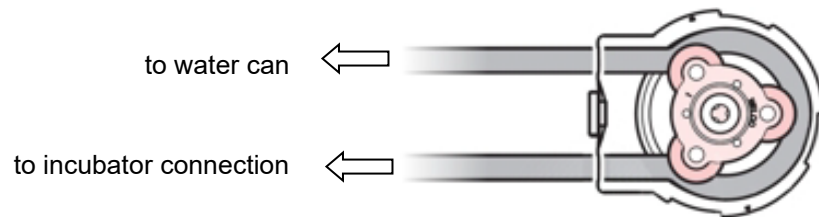

Figure 25: Inserting the silicone tube into the pump head ②

- Insert the pump head (12) into the pump connector (13) and turn it clockwise until it snaps into place.
- Attach the silicone tube to the incubator connection. ③

Now you can attach the freshwater can at the chamber and establish the hose connection to the freshwater can.

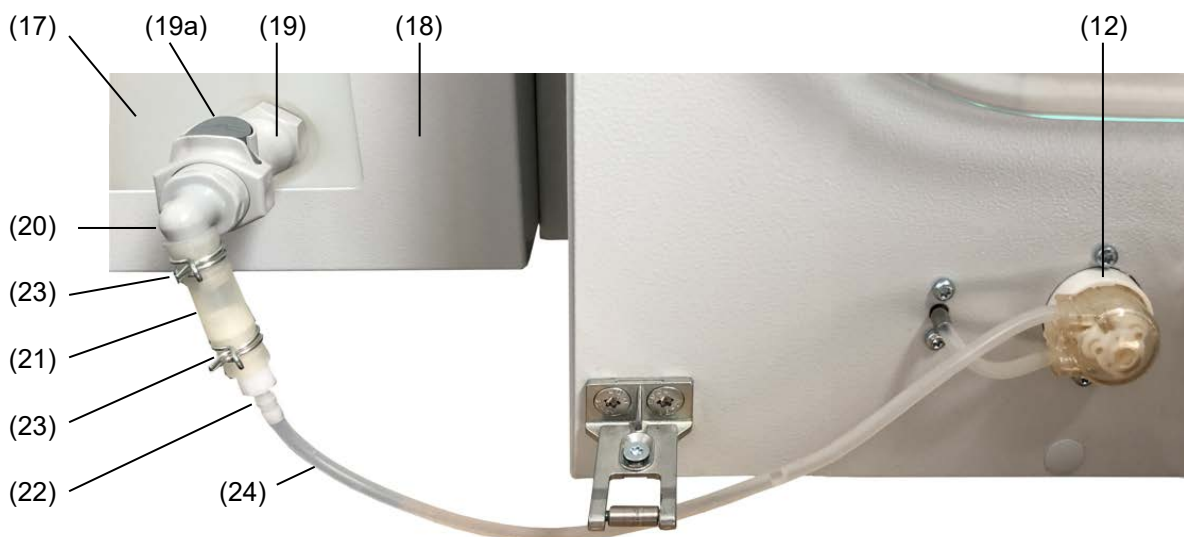

Figure 26: Installation of the water supply via freshwater can, example with single chamber

- |  |   |
|--|---|
| (17) Freshwater can                          | (22) Reducing connector   |
| (18) Magnetic can holder (water can support) | (23) Wire tension clamp   |
| (19) Hose coupling with aqua stop            | (24) Silicone tube DN 3mm to the pump (or via T-type tube connector (T-piece) to another chamber) |
| (19a) Removal button                         | (12) Pump   |
| (20) Angular coupling plug with aqua stop    |   |
| (21) Silicone tube d 10                      |   |

Please proceed in the following order:

- Assemble the magnetic can holder (18): Attach the water can support to the holder
- Attach the magnetic can holder (18) to the left chamber side
- Insert the freshwater can (17) from above into the water can support
- Screw the hose coupling with aqua stop (19) on the water can outlet
- Insert the angular coupling plug (20) into the hose coupling. The gray removal button (19a) on the hose coupling snaps into place.
- Attach a 5 cm piece of the silicone tube d10 (21) to the angular coupling plug.
- Insert the reducing connector (22) into the silicone tube (21)
- Secure both sides of the silicone tube (21) each with a wire tension clamp (23)

**Water supply for a single chamber:**

- Plug the silicone tube DN 3mm (24) coming from the pump (12) on the reducing connector (22)

**Water supply for several chambers:**

You can branch off the water supply via T-pieces for additional chambers.

- Divide the silicone tube DN 3mm (24) into pieces of a suitable length. Take into account the height of the magnetic can holder
- Put a piece of the silicone tube DN 3mm (24) on the reducing connector (22) and connect a T-piece to the free end
- If there are more than two chambers, you can connect another T-piece using a piece of the silicone tube DN 3mm (24)
- For each chamber, plug the silicone tube DN 3mm (24) coming from the pump (12) onto the free outlet of the T-piece

Now you can fill the freshwater can. Observe water quality and temperature. Do not firmly close the lid of the freshwater can to allow air to enter the freshwater can. As a result, obstruction of the water supply due to negative pressure inside the can is avoided.

#### **4.5.4.3 Refilling the freshwater can**

For refilling later, you can remove the freshwater can from the water can support. Press the grey removal button on the hose coupling, then the angle coupling plug can be removed. A small amount of water can escape (filling amount of the angular coupling plug). The water can outlet remains closed due to the aqua stop.



Alternatively, you can remove the lid and fill the can on site with a suitable aid (water hose, watering can). When filling on site, the existing hose connection can remain on the freshwater can.

## 4.6 Electrical connection

The chambers are supplied ready for connection. They come with an IEC connector plug.

Model	Power plug	Voltage +/-10 %	Power frequency	Chamber fuse
CB 56	Grounded plug IEC 7/7	200-230 V (1N~)	50/60 Hz	10 A
CB 56-UL	NEMA 5-20P	100-120 V (1N~)	50/60 Hz	12.5 A
CB 170 CBF 170	Grounded plug IEC 7/7	200-230 V (1N~)	50/60 Hz	10 A
CB 170-UL CBF 170-UL	NEMA 5-20P	100-120 V (1N~)	50/60 Hz	16 A
CB 260 CBF 260	Grounded plug IEC 7/7	200-230 V (1N~)	50/60 Hz	10 A
CB 260-UL CBF 260-UL	NEMA 5-20P	100-120 V (1N~)	50/60 Hz	16 A

- The domestic socket must also provide a protective conductor. Make sure that the connection of the protective conductor of the domestic installations to the chamber's protective conductor meets the latest technology. The protective conductors of the socket and plug must be compatible!

	 <b>DANGER</b>
	<p><b>Electrical hazard due to missing protective conductor connection.</b> <b>Deadly electric shock.</b></p> <ul style="list-style-type: none"> <li>➤ Make sure that the chamber's power plug and the power socket match and securely connect the electrical protective conductors of the chamber and the house installation.</li> </ul>

- Use only the original connection cables from BINDER according to the above specification.  
UL chambers: Use only a UL Listed Power supply cord (UL category ELBZ), SJT 3x14 AWG (2.08 mm<sup>2</sup>). For outside USA use a certified power supply cord according to national requirements.
- Prior to connection and start-up, check the power supply voltage. Compare the values to the specified data located on the chamber's type plate (left chamber side, bottom right-hand, see chap. 1.6).

	<b>NOTICE</b>
	<p><b>Danger of incorrect power supply voltage due to improper connection.</b> <b>Damage to the chamber.</b></p> <ul style="list-style-type: none"> <li>➤ Check the power supply voltage before connection and start-up.</li> <li>➤ Compare the power supply voltage with the data indicated on the type plate.</li> </ul>

- When connecting the chamber, please observe the regulations specified by the local electricity supply company as well as the local and national regulations (VDE directives for Germany).
- Make sure that there is sufficient current protection in accordance with the number of devices that are to be operated. We recommend the use of a residual current circuit breaker.
- Pollution degree (acc. to IEC 61010-1): 2
- Over-voltage category (acc. to IEC 61010-1): II

See also electrical data (chap. 24.4).



To completely separate the chamber from the power supply, you must disconnect the power plug. Install the chamber in a way that the power plug is easily accessible and can be easily pulled in case of danger.

#### 4.7 Divided inner door with cell therapy compartmentation (optional)

With this option, the chambers are equipped with a divided inner door and additional dividers for compartmentation to prevent mixing up of sample vessels.



Figure 27: A look inside an incubator with the "Divided inner door with cell therapy compartmentation" option

##### 4.7.1 Special model CBF 260 "Cell Therapy"

As model variant CBF 260 "Cell Therapy" the chamber is equipped with O<sub>2</sub> control in the range of 0.2–20 Vol.-% and the divided inner door with cell therapy compartmentation.

Variant no.: 9640-0025 (230V) and 9640-0026 (120V)



Figure 28: CBF 260 "Cell Therapy"

#### 4.7.2 Handling and aligning the divided inner door

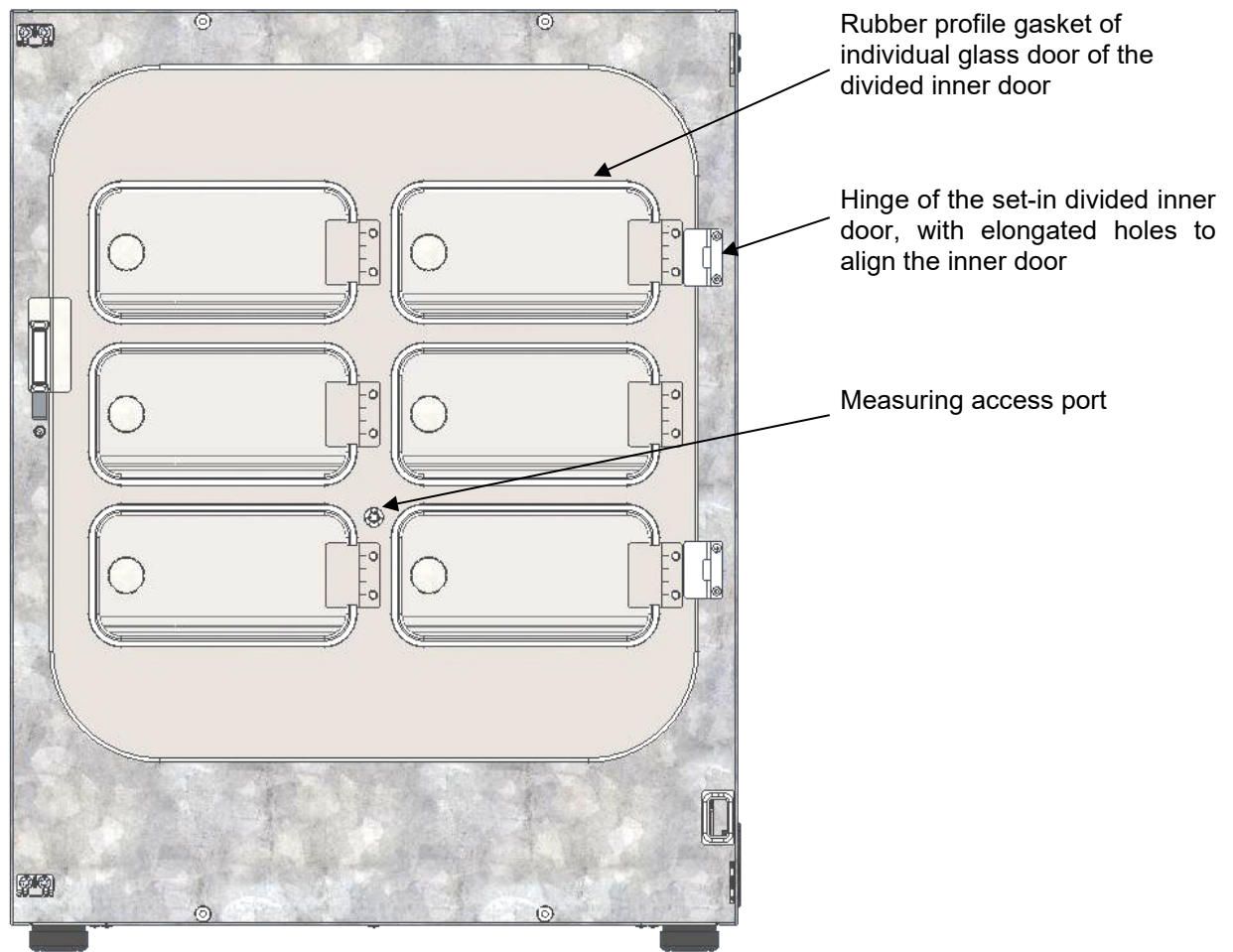

Figure 29: Divided inner door (example: CB 170)

- Pull the handles to open each of the individual glass doors. Do not press too hard while closing them to avoid pushing the doors through the gasket into the inner chamber.
- The rubber profile gaskets of the individual glass doors are easy to replace.
- If the divided inner door is not in an aligned position, fasten the hinge screws in the elongated holes of the hinge to align it. Align the door and operate the locking smoothly.

### 4.7.3 Mounting the partition walls for cell therapy compartmentation

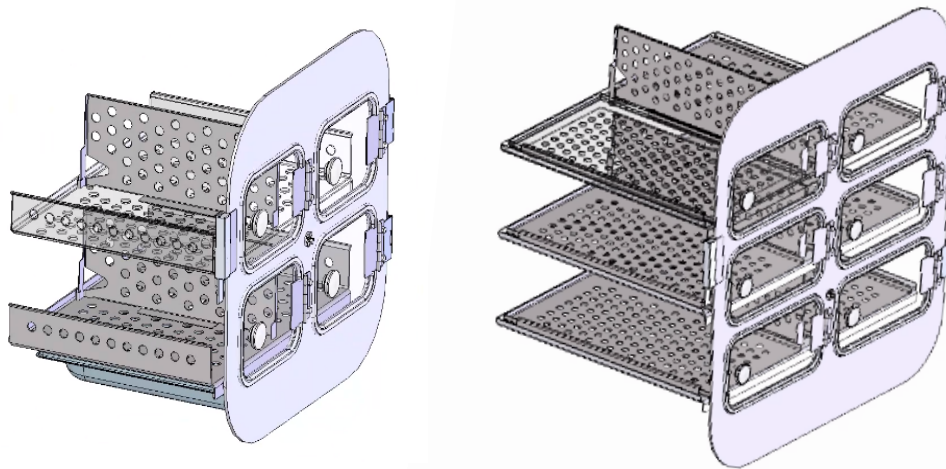
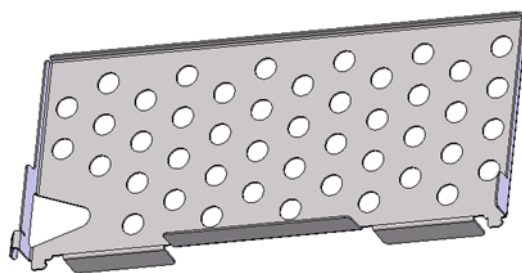

Figure 30: Divided inner door with shelves and partition walls (example, chamber sizes 56 and 170)

The vertical partition wall is used to compartmentalize the interior of the chamber in connection with the divided inner door. This spatially separates the samples.

The partition wall can be assembled or dismantled without tools and has a secure, vertical position. It can also be used for chambers with the “Divided inner door” option.



Rear

Front

Figure 31: Partition wall size 56

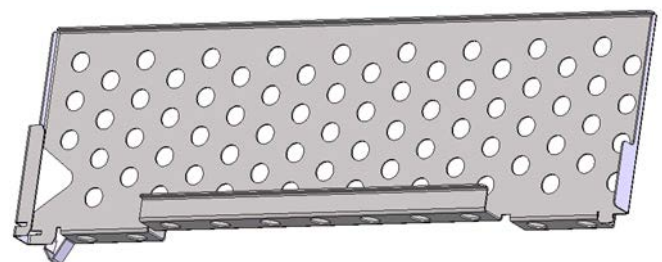

Rear

Front

Figure 32: Partition wall size 170 / 260

For assembly, insert the lower rear end of the partition wall from above into the gap between the shelves so that the rear end hooks onto the rear of the shelf holder.



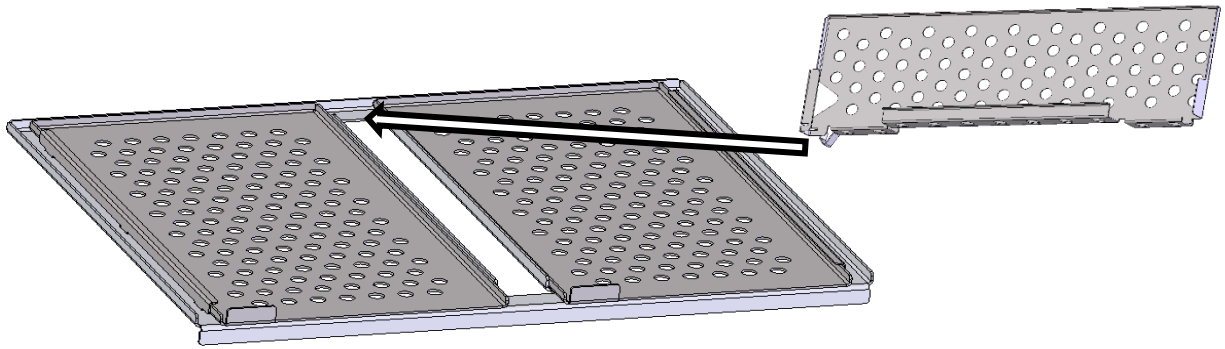
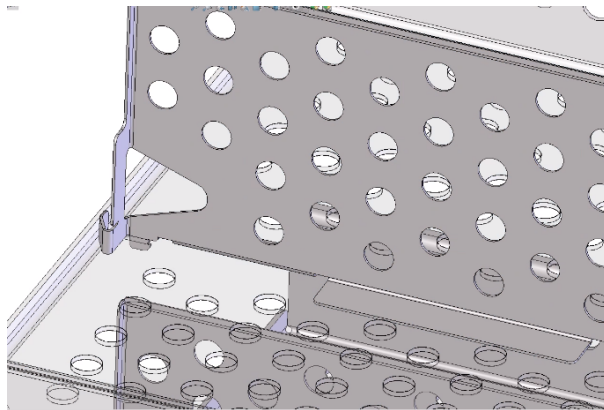

Figure 33: Inserting the partition wall

Then slide the partition towards the back of the chamber until it clicks into place.



Rear

Figure 34: Partition wall, size 56, assembled

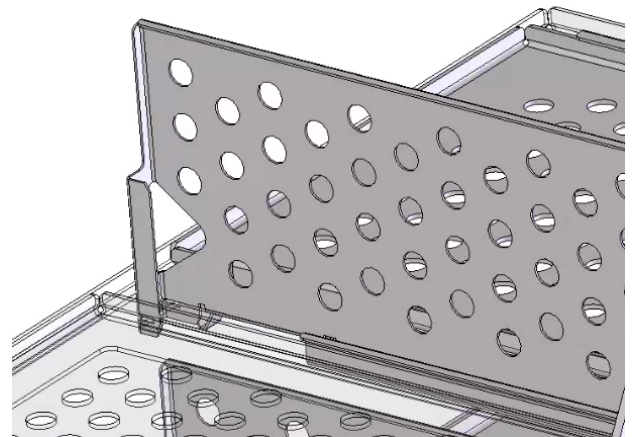

Rear

Figure 35: Partition wall, size 170 / 260, assembled

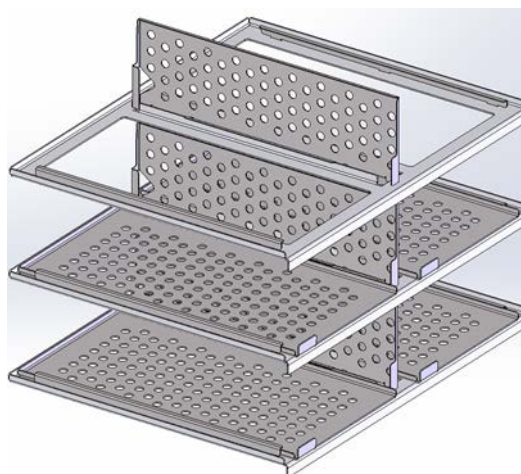

Figure 36: Shelf holder with inserted partition walls (example, size 170)

## 5. Functional overview of the MB2 chamber controller

The MB2 chamber controller controls following parameters inside the chamber:

- Temperature in °C
- Carbon dioxide concentration in vol.-%
- Oxygen concentration in vol.-% (chamber with O<sub>2</sub> control)
- Humidity in % r.h. (CBF / CBF-UL)



Note: In this manual the chambers are described in the maximum equipment variant and including the available options. Therefore, some of the pictured and described features are not available on every chambers

You can enter the desired set point values in fixed value operation mode directly on the display surface or via the setpoint menu. For program operation the controller offers programming week and time programs. In addition there is a timer program available (stopwatch function).

The controller offers various notifications and alarm messages with visual and audible indication and remote alarms via e-mail, an event list (trace file) and the graphical display of the measuring values in the in der chart recorder view. The MB2 program controller permits programming temperature and CO<sub>2</sub> / O<sub>2</sub> and humidity cycles (CBF / CBF-UL), and specifying special controller functions for each program section. You can enter values or programs directly at the controller or use the APT-COM™ 4 Multi Management Software (option) specially developed by BINDER.

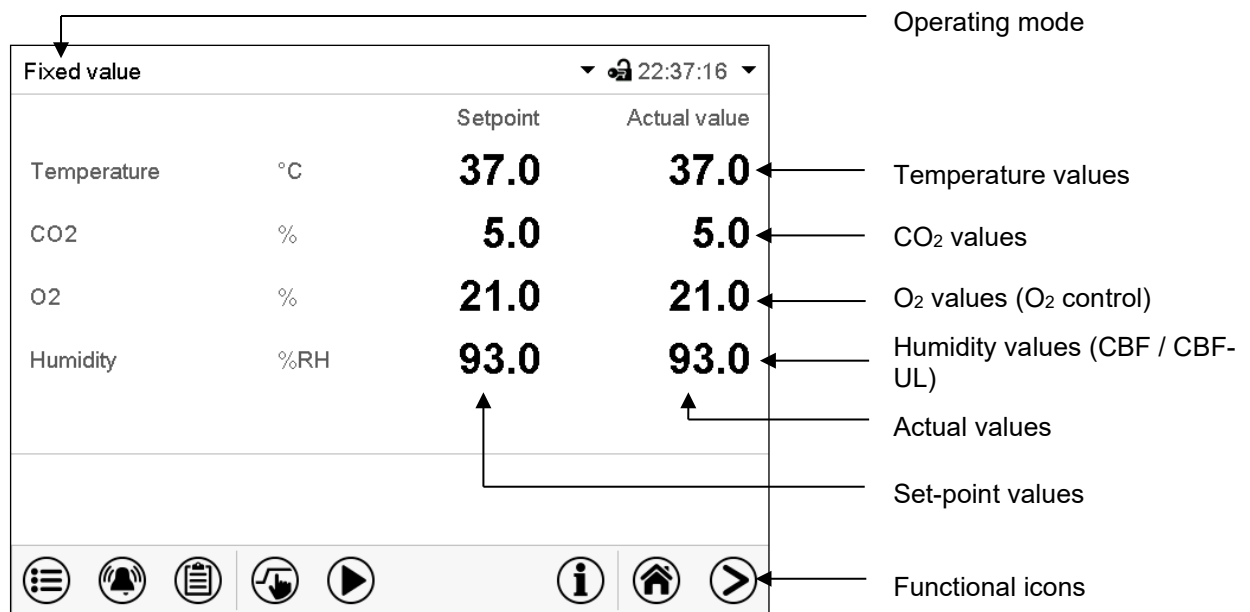

Figure 37: Normal display of the MB2 program controller (sample values, CBF / CBF-UL with O<sub>2</sub> control)

## 5.1 Operating functions in normal display

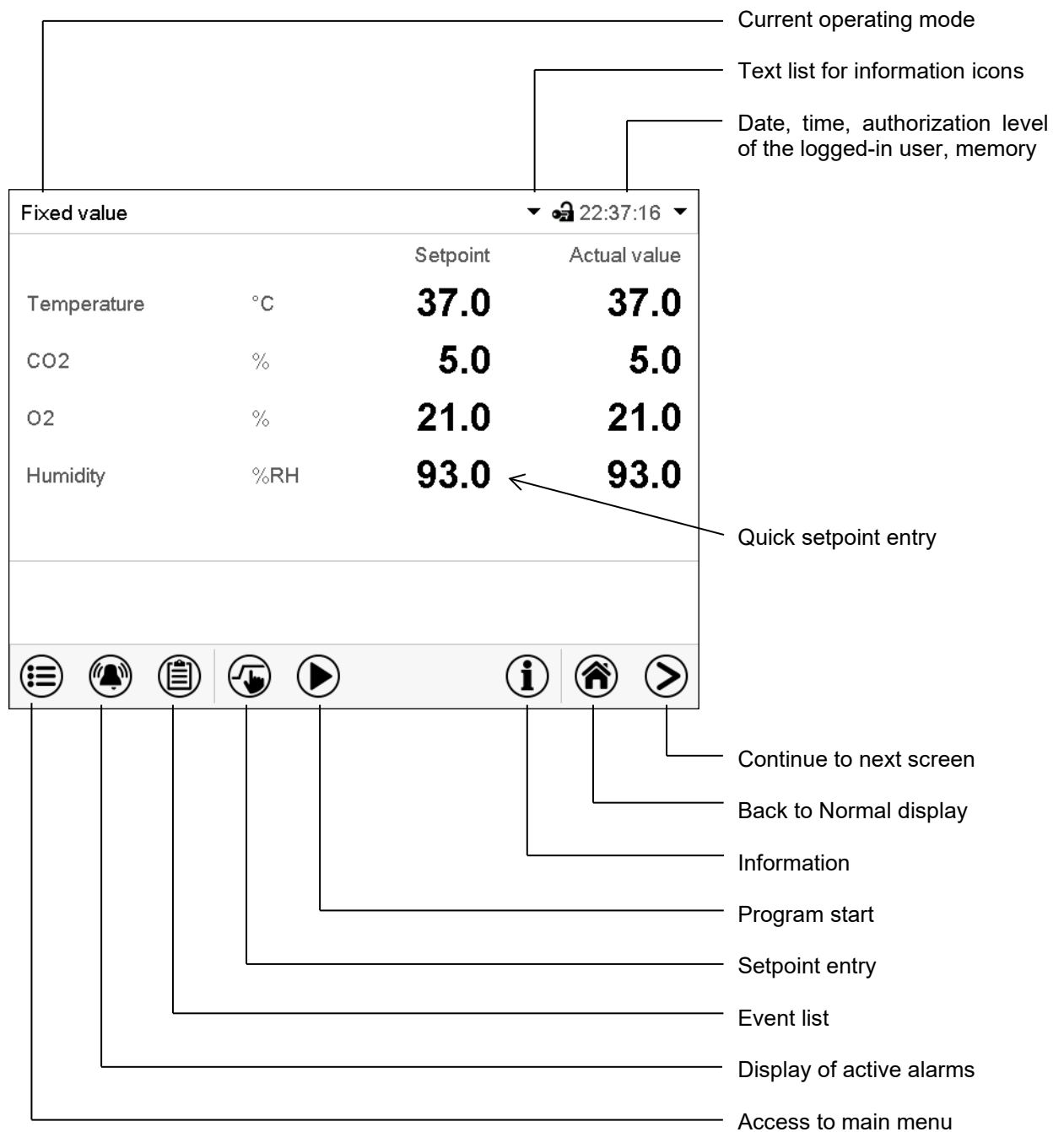

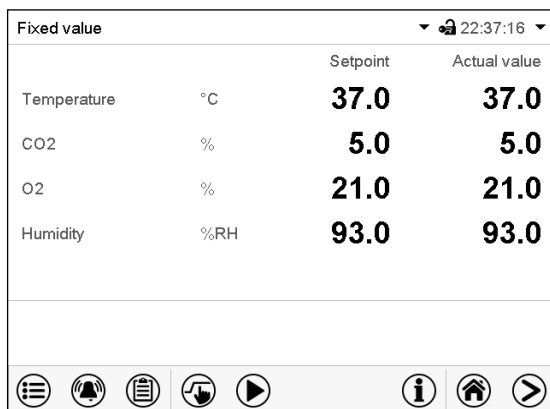

Figure 38: Operating functions of the MB2 controller in normal display (sample values, CBF / CBF-UL with O<sub>2</sub> control)

## 5.2 Display views: Normal display, program display, chart-recorder display

	Press the <b>Change view</b> icon to toggle between normal display, program display and chart-recorder display.
	Press the <b>Normal display</b> icon to return from program display and chart recorder display back to Normal display.



Normal display (actual values / setpoint values)

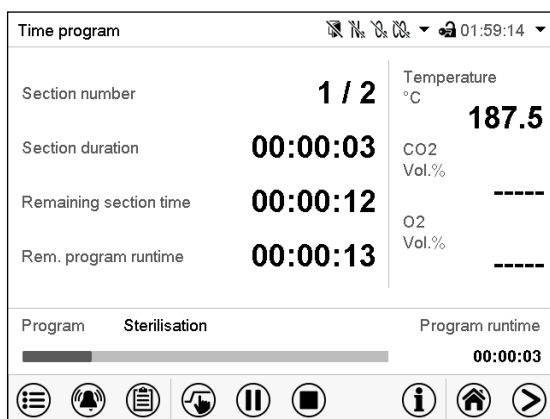

Program display (example: time program)

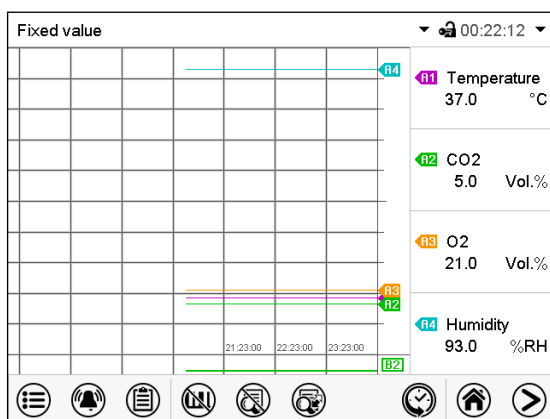











Chart recorder display







(Sample values, CBF / CBF-UL with O<sub>2</sub> control)

### 5.3 Controller icons overview











#### Navigation icons in Normal display

Icon	Signification	Function
	<b>Main menu</b>	Access from Normal display to the main menu
	<b>Alarm</b>	Access from Normal display to the list of active alarms
	<b>Event list</b>	Access from Normal display to the event list
	<b>Setpoint setting</b>	Access from Normal display to the setpoint entry menu: setpoint entry for Fixed value operation, turning on/off CO <sub>2</sub> / O <sub>2</sub> and humidity control (CBF / CBF-UL), safety controller settings
	<b>Program start</b>	Start a previously entered time or week program, continue a paused time program
	<b>Program pause</b>	Pause a running time program
	<b>Program cancelling</b>	Cancel a running time or week program
	<b>Information</b>	Information on program operation, setpoints, actual values, and the safety controller
	<b>Normal display</b>	Return from program display or chart recorder display to Normal display
	<b>Change view</b>	Toggle between Normal display, program display, and chart recorder display







#### Functional icons in individual menus

Icon	Signification	Function
	<b>Back</b>	Return from each menu to Normal display
	<b>Update</b>	Update the event list and alarm messages
	<b>Confirm</b>	Take over the entries and exit the menu / continue menu sequence.
	<b>Close</b>	Exit the menu / cancel menu sequence. Entries are not taken over. When terminating a menu sequence, an information window appears, which must be confirmed.
	<b>Reset alarm</b>	Acknowledge the alarm and mute the buzzer.
	<b>Change keyboard</b>	Change between uppercase and lower case characters, digits and special characters
	<b>Edit</b>	Edit settings of time and week programs

### Functional icons in the chart recorder display

Icon	Signification	Function
	<b>Show legend</b>	Show legend
	<b>Hide legend</b>	Hide legend
	<b>Switch legend</b>	Switch between legend pages
	<b>Show indications</b>	Show indication "Door open" (B2)
	<b>Hide indications</b>	Hide indication "Door open" (B2)
	<b>History display</b>	Pause chart recorder and change to history display. Data recording continues.
	<b>Curve selection</b>	Go to "Curve selection" submenu in the history display
	<b>Search</b>	Go to "Search" submenu in the history display to select the required instant
	<b>Zoom</b>	Go to "Zoom" submenu in the history display to select the zoom factor
	<b>Show scroll buttons</b>	Show scroll buttons in the history display to scroll to an instant
	<b>Hide scroll buttons</b>	Hide scroll buttons in the history display to scroll to an instant

### Information icons referring to chamber conditions

Icon	Text information	Condition
	"Idle mode"	Controller is in Idle mode
	"Door open"	Chamber door is open
	"CO2 pressure alarm off"	CO <sub>2</sub> pressure alarm deactivated
	"O2 pressure alarm off"	O <sub>2</sub> pressure alarm deactivated (chamber with O <sub>2</sub> control)
	"N2 pressure alarm off"	N <sub>2</sub> pressure alarm deactivated (chamber with O <sub>2</sub> control)
	"Interior socket"	Interior socket (option) activated

### Information icon for data processing

Icon	Information
	Waiting icon: Data processing is running. Remaining time to touch the display when calibrating the touchscreen.

## 5.4 Operating modes

The MB2 program controller operates in the following operating modes:

- **Idle mode**

The controller is not functional, i.e., there is no heating, no CO<sub>2</sub> inlet or O<sub>2</sub> inlet (O<sub>2</sub> control) and no humidification (CBF / CBF-UL). The chamber approximates ambient values.

You can activate and deactivate this operating mode with the “Idle mode” control contact in Fixed value operating mode (chap. 7.3), time program operation (chap. 9.7.3) and week program operation (chap. 10.6.5).

- **Fixed value operating mode**

The controller operates as a fixed-point controller, i.e., set-points for temperature, CO<sub>2</sub>, O<sub>2</sub> (O<sub>2</sub> control) and humidity (CBF / CBF-UL) can be defined, which are then maintained until the next manual change (chap. 7.1).

- **Timer program operation**

Stopwatch function: during an entered duration the controller constantly equilibrates to the setpoints entered in Fixed value operation mode.

- **Time program operation**

An entered time program for temperature, CO<sub>2</sub>, O<sub>2</sub> (O<sub>2</sub> control) and humidity (CBF / CBF-UL) is running. The controller offers 25 program memory places with 100 program sections each. The total number of program sections of all programs is unlimited







- **Week program operation**

An entered week program for temperature, CO<sub>2</sub>, O<sub>2</sub> (O<sub>2</sub> control) and humidity (CBF / CBF-UL) is running. The controller offers 5 program memory places with 100 switching points each. The switching points can be distributed over all days of the week.

## 5.5 Controller menu structure



Fixed value		Setpoint	Actual value
Temperature	°C	<b>37.0</b>	<b>37.0</b>
CO <sub>2</sub>	%	<b>5.0</b>	<b>5.0</b>
O <sub>2</sub>	%	<b>21.0</b>	<b>21.0</b>
Humidity	%RH	<b>93.0</b>	<b>93.0</b>



  

						
---	---	---	---	---	---	---

Use the **navigation icons** in the screen footer in Normal display to access the desired controller functions.

The available functions depend on the current **authorization level** “Service”, “Admin” or “User” (chap. 13.1). This is selected either during login or can be available without password protection.



	<b>Main menu:</b> program settings, further information, “Service” submenu. The “Settings” submenu allows general configuration of the controller.	chap. 5.5.1
	List of <b>active alarms</b>	chap. 11
	Access to the <b>event list</b>	chap. 15.3

	<b>Setpoint entry</b> for Fixed value operation, turning on/off <b>CO<sub>2</sub> control</b> , <b>O<sub>2</sub> control</b> (chamber with O <sub>2</sub> control) and <b>humidity control</b> (CBF / CBF-UL); <b>safety controller</b> settings	chap. 7, 6.7, 12.2
	Start/ pause/ cancel an already entered, respectively a running <b>time program</b> or start / cancel an already entered, respectively a running <b>week program</b>	chap. 9.1, 9.2, 10.1

Unless noted otherwise, the figures show the functional range, which is available for the user with “Admin” authorization level.

### 5.5.1 Main menu

The main menu provides access to the general configuration of the controller as well as to program entry and the user administration. Additionally there are support functions like a contact page or the display calibration depending on the available angle.

	Press the <b>Main menu</b> icon to access the main menu from Normal Display.
	Press the <b>Back</b> icon to return from each setting menu to Normal Display.

The main menu provides the following functions and submenus.

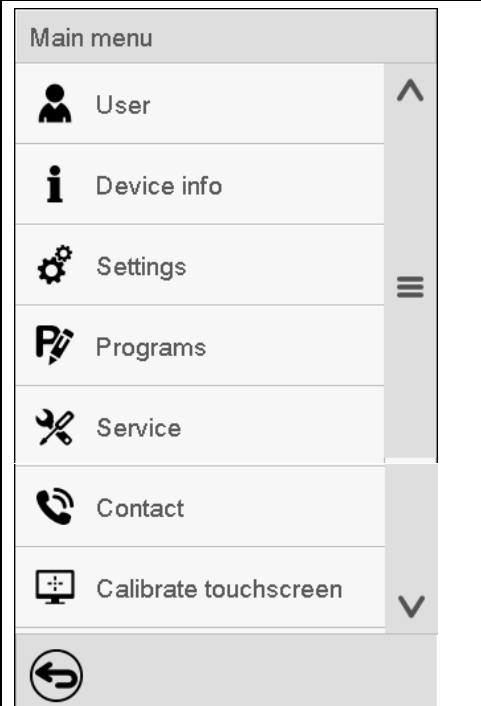
	<table border="1"> <tr> <td data-bbox="718 1016 1251 1093">           User management: login and logout, password management         </td> <td data-bbox="1251 1016 1471 1093">           chap. 13         </td> </tr> <tr> <td data-bbox="718 1093 1251 1169">           Chamber information         </td> <td data-bbox="1251 1093 1471 1169">           chap. 15.2         </td> </tr> <tr> <td data-bbox="718 1169 1251 1245">           “Settings” submenu (not visible for user with “User” authorization level)         </td> <td data-bbox="1251 1169 1471 1245">           chap. 14         </td> </tr> <tr> <td data-bbox="718 1245 1251 1321">           Program entry submenu for time and week programs         </td> <td data-bbox="1251 1245 1471 1321">           chap. 9 and 10         </td> </tr> <tr> <td data-bbox="718 1321 1251 1397">           “Service” submenu         </td> <td data-bbox="1251 1321 1471 1397">           chap. 5.5.3         </td> </tr> <tr> <td data-bbox="718 1397 1251 1473">           BINDER Service contact page         </td> <td data-bbox="1251 1397 1471 1473">           chap. 15.1         </td> </tr> <tr> <td data-bbox="718 1473 1251 1550">           Calibrating the touch screen         </td> <td data-bbox="1251 1473 1471 1550">           chap. 14.4.2         </td> </tr> <tr> <td data-bbox="718 1550 1251 1655">           Back to Normal Display         </td> <td data-bbox="1251 1550 1471 1655"></td> </tr> </table>	User management: login and logout, password management	chap. 13	Chamber information	chap. 15.2	“Settings” submenu (not visible for user with “User” authorization level)	chap. 14	Program entry submenu for time and week programs	chap. 9 and 10	“Service” submenu	chap. 5.5.3	BINDER Service contact page	chap. 15.1	Calibrating the touch screen	chap. 14.4.2	Back to Normal Display	
User management: login and logout, password management	chap. 13																
Chamber information	chap. 15.2																
“Settings” submenu (not visible for user with “User” authorization level)	chap. 14																
Program entry submenu for time and week programs	chap. 9 and 10																
“Service” submenu	chap. 5.5.3																
BINDER Service contact page	chap. 15.1																
Calibrating the touch screen	chap. 14.4.2																
Back to Normal Display																	

#### “Settings” submenu

- Settings of many general controller functions and network settings (chap. 14).
- Available only for users with “Service” and “Admin” authorization level

#### “Service” submenu

- Access to service data, controller reset to factory settings (chap. 5.5.3)
- Available only for users with “Service” and “Admin” authorization level. Full functional range only for BINDER Service (users with “Service” authorization level).

#### “Programs” submenu

- Access to the controller’s program functions (chap. 8, 9, 10)



### 5.5.2 “Settings” submenu

The “Settings” submenu is available for users with “Service” or “Admin” authorization level. It serves to enter date and time, select the language for the controller menus and the desired temperature unit and to configure the controller’s communication functions.

Path: [Main menu](#) > [Settings](#)

<table border="1"> <tr><td>Main</td><td>Settings</td></tr> <tr><td></td><td> Chamber</td></tr> <tr><td></td><td> Date and time</td></tr> <tr><td></td><td> Display</td></tr> <tr><td></td><td> Measurement chart</td></tr> <tr><td></td><td> Various</td></tr> <tr><td></td><td> Serial interfaces</td></tr> <tr><td></td><td> Ethernet</td></tr> <tr><td></td><td> Web server</td></tr> <tr><td></td><td> email</td></tr> <tr><td></td><td></td></tr> </table>	Main	Settings		Chamber		Date and time		Display		Measurement chart		Various		Serial interfaces		Ethernet		Web server		email			Setting the temperature unit, menu language...	chap. 14.1, 14.2
	Main	Settings																						
		Chamber																						
		Date and time																						
		Display																						
		Measurement chart																						
		Various																						
		Serial interfaces																						
		Ethernet																						
		Web server																						
		email																						
	Setting date and time	chap. 14.2																						
Setting the display brightness, continuous operation and screen saver	chap. 14.4																							
Settings for the measurement chart: storage interval, storage values, minimum and maximum values	chap. 16.2																							
Setting the tolerance range and delay time for tolerance range alarm	chap. 11.4																							
Configuration of the RS485 interface (available via BINDER INDIVIDUAL Customized Solutions)	chap. 14.5.1																							
Entry of the MAC address and IP address	chap. 14.5.2																							
No function																								
Configuration of the e-mail server, assignment of e-mail addresses	chap. 14.5.33																							
Back to main menu																								

### 5.5.3 “Service” submenu

The “Service” submenu is available for users with “Service” or “Admin” authorization level. When logged-in with “Admin” authorization level the user will find information to tell the BINDER Service in service case.

Path: [Main menu](#) > [Service](#)

<table border="1"> <tr><td>Main</td><td>Service</td></tr> <tr><td></td><td> Service data</td></tr> <tr><td></td><td> Counter</td></tr> <tr><td></td><td> ST code</td></tr> <tr><td></td><td> Factory settings</td></tr> <tr><td></td><td></td></tr> </table>	Main	Service		Service data		Counter		ST code		Factory settings			Serial number of the chamber, setup version of the controller software	chap. 14.2
	Main	Service												
		Service data												
		Counter												
		ST code												
		Factory settings												
No function														
Information for BINDER Service														
Reset to factory settings														
Back to main menu														

(view with “Admin” authorization level)

## 5.6 Principle of controller entries

In the selection and entry menus there are icons displayed in the footers which you can use to take over the entry or cancel it.

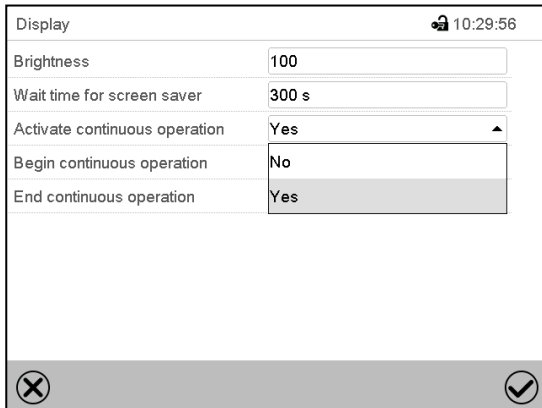

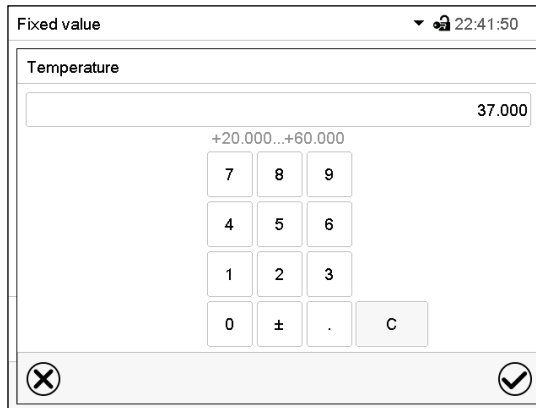

Selection menu (example)



Entry menu (example)

After completing the settings there are the following possibilities:

	Press the <b>Confirm</b> icon to take over the entries and exit the menu or continue the menu sequence.
	Press the <b>Close</b> icon to exit the menu or cancel the menu sequence without taking over the entries. When terminating a menu sequence, an information window appears, which must be confirmed.

## 5.7 Performance during and after power failures

During a power failure, all controller functions are shut down. The gas inlet valves are closed so that no gas can escape into the ambient air. The zero-voltage relay alarm output (3) (chap. 11.6) is switched to alarm position for the whole duration of the power failure.

After the power returns, all functions return to the same status the chamber had before power failure. The controller continues to function in the original operating mode it was in previously before the power failure occurred.

- Performance after power failure in Idle mode  
Control is deactivated
- Performance after power failure in Fixed value operation mode  
All functions return to the same status the chamber had before power failure. The set-points are immediately resumed.
- Performance after power failure during time program operation  
The program is resumed at the point where the interruption occurred with the latest set-points reached during the program run.
- Performance after power failure during week program operation  
The week program continues with the values corresponding to the current time.
- Performance after power failure during sterilization operation  
The sterilization process is cancelled and the controller changes to Fixed value operation mode with the setpoints already entered. All setpoint values remain in memory.

Power failure and power return are noted in the event list (chap. 15.3).

If during power failure the inner chamber temperature or the CO<sub>2</sub> / O<sub>2</sub> concentration (chamber with O<sub>2</sub> control) or humidity (CBF / CBF-UL) has fallen below the alarm thresholds, confirm the alarms (e.g., tolerance range, safety controller). See chap. 11.3.

## 5.8 Performance when opening the door

When you open the door, CO<sub>2</sub> control and O<sub>2</sub> control (chamber with O<sub>2</sub> control) immediately turns off.

After 60 seconds from opening the door, the heating and humidification (CBF / CBF-UL) turn off.

After closing the door, heating, CO<sub>2</sub> control, O<sub>2</sub> control (chamber with O<sub>2</sub> control), humidification (CBF / CBF-UL) turn on again.

## 6. Start up

### 6.1 Turning on the chamber

After connecting the supply lines (chap. 4), turn on the chamber by its main power switch. The lit pilot lamp shows the chamber is ready for operation.

When the main power switch is turned on and yet the controller display is dark, the display is in stand-by mode. Press on the touchscreen to activate it.

Check that the CO<sub>2</sub> control is activated (chap. 6.7).

**CBF / CBF-UL:** Fill the freshwater bag (chap. 4.5). Check that the humidifying system is activated (chap. 6.7).

After the first turning on of the chamber or after an interruption of the power supply the relative humidity will increase after a delay of about 20 minutes. During this period, the relative humidity can drop considerably.

*Chamber with O<sub>2</sub> control:* Check that the O<sub>2</sub> control is activated (chap. 6.7).

Warming chambers may release odors in the first few days after commissioning. This is not a quality defect. To reduce odors quickly we recommend heating up the chamber to its nominal temperature for one day and in a well-ventilated location.



**WARNING:** If customer should use a BINDER chamber running in non-supervised continuous operation, we strongly recommend in case of inclusion of irrecoverable specimen or samples to split such specimen or samples and store them in at least two chambers, if this is feasible.

## 6.2 Controller settings upon start up

The window „Language selection“ enables the **language selection**, in case that it's activated in the “Start-up” menu. Afterwards occurs a request of the **time zone** and the **temperature unit**.

Language selection

German

English

French

Spanish

Italian

✓

Start-up

Temperature unit: Degrees Celsius

Time zone: UTC+1h (CET)

Daylight saving time switch: Automatic

Start of daylight saving time

End of daylight saving time

Language query after restart: Yes

✗ ✓

The controller will function in the **operating mode**, which was active before the last shut-down. It controls temperature, CO<sub>2</sub>, O<sub>2</sub> (chamber with O<sub>2</sub> control) and humidity (CBF / CBF-UL) in fixed value operating mode to the last entered values and in the program mode to the set points achieved beforehand.

### Locked operation

Provided that the user administration has been activated by the assignment of passwords for the different authorization types, the **controller operation** is first locked after turning on the unit, recognizable by the closed lock icon in the header.

Fixed value		Setpoint	Actual value
Temperature	°C	37.0	37.0
CO <sub>2</sub>	%	5.0	5.0
O <sub>2</sub>	%	21.0	21.0
Humidity	%RH	93.0	93.0



In the locked view the controller provides all display functions. No setting functions are available.

The setpoints are shaded (light grey) in normal display. Changing them by direct entry in the fixed value operating mode is not possible. The functional icons for setpoint entry and program start in the footer are without function.

After turning on the unit, user log-in is required to operate the controller (chap. 13.2)

### Operation without user log-in / without password-protection

If the password function has been deactivated, after turning on the unit without user log-in there are those controller functions available, which correspond to the highest authorization level without a password protection. There is no lock icon in the header.

## 6.3 Factory settings

The chamber is supplied with the following basic preset parameters:

- Temperature setpoint 37 °C / 98.6 °F
- CO<sub>2</sub> setpoint 5 vol.-%
- O<sub>2</sub> setpoint (chamber with O<sub>2</sub> control) 21 vol.-%
- Humidity setpoint (CBF / CBF-UL) 93 % r.h.
- Safety controller class 3.1 Offset 2 °C
- Sterilization temperature (set-point) 180 °C / 356 °F
- Audible alarm signal (buzzer) activated

The set temperature determines the target working temperature in the inner chamber, i.e. set value 37 °C / 98.6°F = target working temperature 37 °C / 98.6°F. The same is valid for the CO<sub>2</sub> and O<sub>2</sub> concentration (chamber with O<sub>2</sub> control) and humidity (CBF / CBF-UL). For the hot-air sterilization, the set value is 180 °C / 356 °F and cannot be changed.



As long as there is a difference between the actual and set value shown in the display, adequate operation of the chamber is not guaranteed.

## 6.4 Equilibration time

### Temperature

- Equilibration time is max. 4 hours.

### CO<sub>2</sub>

- After turning in the chamber, after approx. 5 minutes the CO<sub>2</sub> concentration equilibrates automatically to the pre-set value of 5 vol.-% CO<sub>2</sub>.
- Equilibration time is max. 0.5 hours.

### O<sub>2</sub> (chamber with O<sub>2</sub> control)

- After turning in the chamber, the ambient oxygen concentration of approx. 20.9 vol.-% is displayed after a delay of 10 minutes. During the first 10 minutes, O<sub>2</sub> control is not defined. Then O<sub>2</sub> is regulated to the displayed setpoint value of 21 vol.-%.
- For high O<sub>2</sub> setpoint values (with alternative control range option), equilibration time is max. 1.5 hours.



### Humidity (CB / CB-UL)

- With humidity control effected via the Permadyr<sup>®</sup> system equilibration time is max. 15 hours

### Humidity (CBF / CBF-UL)

- Equilibration time is max. 1 hour.

## 6.5 Operating the DuoDoor™ door lock

	 <b>WARNING</b>
<p><b>Magnets can affect the function of pacemakers and implanted defibrillators. A pacemaker can be put into test mode and cause discomfort. A defibrillator may not work anymore.</b></p> <ul style="list-style-type: none"> <li>➤ If you wear such devices, maintain a sufficient safety distance to the chamber door in the area of the door handle.</li> <li>➤ Warn wearers of such devices of approaching the chamber door.</li> </ul>	

The DuoDoor™ door lock offers two different ways to open the doors, dependent on the glass door lock position.

### Opening outer door and glass door independently

When closing the glass door, close the glass door lock.

Then you can close and open the outer door using its handle. The glass door will remain closed until you manually open the glass door lock.

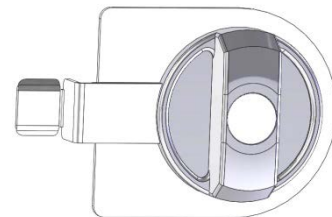

Figure 39: Closed position

### Opening outer door and glass together

When closing the glass door leave the glass door lock in open position. Then close the outer door. The glass door is pressed against the gasket so that both doors are securely closed.

When opening the outer door, a magnetic device also opens the glass door.

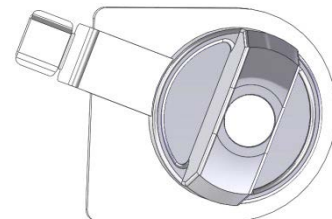

Figure 40: Open position

## 6.6 Required gas supply for the chamber with O<sub>2</sub> control

In the chamber with O<sub>2</sub> control, cell growth can be additionally influenced by a variable oxygen content. Depending on the required range of O<sub>2</sub> concentration, the type of gas which is required may vary. To this end, two equipment variants are available:

### 6.6.1 Hypoxic control range 0.2 vol.-% up to 20 vol.-% O<sub>2</sub> (regular)

In addition to the CO<sub>2</sub> connection, the chamber provides a gas connection for N<sub>2</sub>.

As compared to the ambient air (O<sub>2</sub> concentration of 20.9 vol.-%) only the N<sub>2</sub> concentration needs to be increased, no oxygen is required for the O<sub>2</sub> control. Therefore, it is not necessary and possible to connect an O<sub>2</sub> cylinder. Even with activated O<sub>2</sub> control no O<sub>2</sub> pressure alarm will be emitted.

### 6.6.2 Alternative control range 10 vol.-% up to 90 vol.-% (option)

In addition to the CO<sub>2</sub> connection, the chamber provides gas connections for O<sub>2</sub> and N<sub>2</sub>.

- **Operation in the hyperoxic range (> 22 vol.-% O<sub>2</sub>)**

As compared to the ambient air (O<sub>2</sub> concentration of 20.9 vol.-%) only the O<sub>2</sub> concentration needs to be increased, no nitrogen is required for the O<sub>2</sub> control. Therefore, it is not necessary to connect a N<sub>2</sub> cylinder.

You can deactivate the N<sub>2</sub> pressure alarm in the controller (chap. 7.3). Then also with activated O<sub>2</sub> control no N<sub>2</sub> pressure alarm will be emitted.

- **Alternating operation in the hyperoxic and hypoxic range or in the range from 20 vol.-% O<sub>2</sub> up to 22 vol.-% O<sub>2</sub>**

N<sub>2</sub> and O<sub>2</sub> are required for O<sub>2</sub> control. It is necessary to connect all gas supplies.

You can deactivate the O<sub>2</sub> and / or N<sub>2</sub> pressure alarm in the controller (chap. 7.3). Then also with activated O<sub>2</sub> control no O<sub>2</sub> and / or N<sub>2</sub> pressure alarm will be emitted.

### 6.6.3 Operation without O<sub>2</sub> control

You can deactivate the O<sub>2</sub> control in the controller (chap. 6.7). With this setting, no O<sub>2</sub> and N<sub>2</sub> pressure alarms and no O<sub>2</sub> tolerance range alarm will be issued. The zero-voltage relay alarm contact (chap. 11.6) will also not be triggered.

Since neither nitrogen nor oxygen are required, it is not necessary to connect an O<sub>2</sub> or N<sub>2</sub> cylinder.

## 6.7 Activating / deactivating CO<sub>2</sub>, O<sub>2</sub> and humidity control

If CO<sub>2</sub> control and/or O<sub>2</sub> control (chamber with O<sub>2</sub> control) and/or humidity control (CBF / CBF-UL) shall not be used, it is possible to deactivate them in the controller.



Press the **Setpoint setting** icon to access the “Setpoint” setting menu from Normal display.

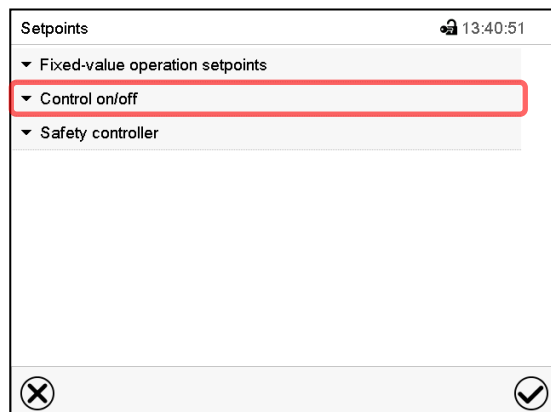

“Setpoints” menu.  
Select “Control on/off”.

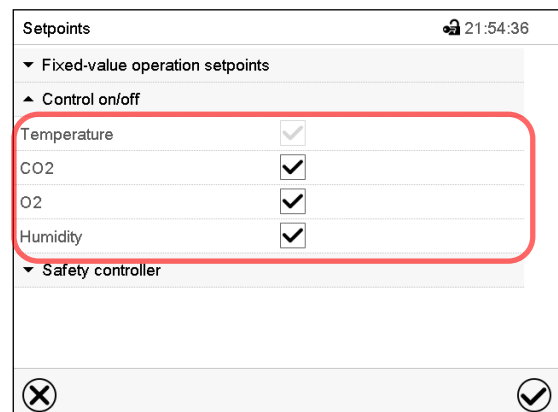

You can turn on or off CO<sub>2</sub> control and O<sub>2</sub> control (chamber with O<sub>2</sub> control) and humidity control (CBF / CBF-UL)

Mark / unmark the checkbox to activate / deactivate the desired function and press the **Confirm** icon.



When operating the chamber with deactivated CO<sub>2</sub> control, no CO<sub>2</sub> pressure alarm and no CO<sub>2</sub> tolerance range alarm will be emitted.



*Chamber with O<sub>2</sub> control:* When operating the chamber with deactivated O<sub>2</sub> control, no O<sub>2</sub> and N<sub>2</sub> pressure alarms and no O<sub>2</sub> tolerance range alarm will be emitted.



CBF / CBF-UL: When operating the chamber with deactivated humidity control no humidity tolerance range alarm will be emitted. The controller continues to show the actual humidity value but no longer the humidity set-point.

## 6.8 CB / CB-UL: Humidity control of the Permadyr™ system



With the CBF / CBF-UL, humidity setting via the Permadyr™ System is not used.

The Permadyr™ system with its 2-pan water system guarantees a maximum humidity of up to 95 % r.H. in the inner chamber, which remains condensation-free. This performance assumes an average ambient temperature of 22 +/- 3 °C / 71.6 +/- 5.4 °F and a working temperature in the inner chamber of 37 °C / 98.6 °F.

You can increase or decrease humidity slightly via the heating of the water pan if required.

Humidity is infinitely adjustable in whole numbers from -5 (low) to +5 (high).

Factory setting: "0" (medium).

### Setting:

Path: [Main menu](#) > [Settings](#) > [Various](#)

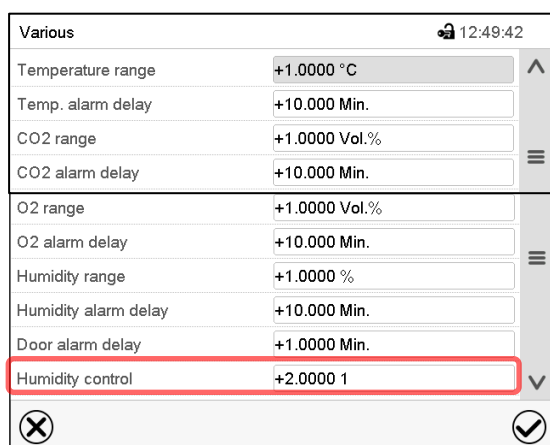

Various		12:49:42
Temperature range	+1.0000 °C	^
Temp. alarm delay	+10.000 Min.	
CO2 range	+1.0000 Vol.%	
CO2 alarm delay	+10.000 Min.	
O2 range	+1.0000 Vol.%	
O2 alarm delay	+10.000 Min.	
Humidity range	+1.0000 %	
Humidity alarm delay	+10.000 Min.	
Door alarm delay	+1.0000 Min.	
Humidity control	+2.0000 1	∨

Submenu "Various".

Select the field "Humidity control"

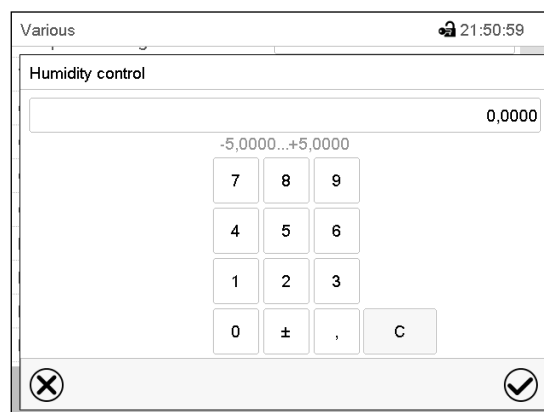
Various		21:50:59
Humidity control		
0,0000		
-5,0000...+5,0000		
7	8	9
4	5	6
1	2	3
0	±	,
		C

"Humidity control" entry menu. Enter the desired humidity and confirm entry with **Confirm** icon.



If the ambient temperature deviates by more than +/- 5 °C from the values recommended by the manufacturer, the conditions for maximum air humidity with condensation-free inner chamber are no longer guaranteed. Contact BINDER Service for assistance.



## 7. Set-point entry in “Fixed value” operating mode

In Fixed value operating mode you can enter set-points for temperature, CO<sub>2</sub> and O<sub>2</sub> (chamber with O<sub>2</sub> control) and humidity (CBF / CBF-UL), and the switching-state of up to 16 operation lines.

All settings made in Fixed value operating mode remain valid until the next manual change. They are saved also when turning off the chamber or in case of toggling to Idle Mode or Program Mode.

	Setting ranges	Control ranges
<b>Temperature</b>	20 °C / 68 °F up to 60 °C / 140 °F	4 °C / 7.2 °F above ambient temperature up to 60 °C / 140 °F
<b>Temperature</b> (chamber with O <sub>2</sub> control)	20 °C / 68 °F up to 60 °C / 140 °F	6 °C / 10.8 °F above ambient temperature up to 60 °C / 140 °F
<b>CO<sub>2</sub></b>	0 vol.-% up to 20 vol.-%	0 vol.-% up to 20 vol.-%
<b>O<sub>2</sub></b> (chamber with O <sub>2</sub> control, with regular hypoxic control range)	0.2 vol.-% up to 21 vol.-%	0.2 vol.-% up to 20 vol.-%
<b>O<sub>2</sub></b> (chamber with O <sub>2</sub> control, with optional alternative control range)	5 vol.-% up to 90 vol.-%	10 vol.-% up to 90 vol.-%
<b>Humidity</b> (CBF / CBF-UL)	50 % r.h. up to 95 % r.h.	50 % r.h. up to 95 % r.h. (condensation-free up to 90 % r.h.)



With set-point type “**Limit**”, adapt the safety controller (chap. 12.2) always when you changed the temperature set-point. Set the safety controller set-point by approx. 2 °C above the controller temperature set-point.

Recommended setting: Set-point type “**Offset**” with safety controller set-point 2 °C.



When setting a lower temperature setpoint, in order to save time, we recommend cooling down the chamber by turning it off and opening both chamber doors.



When setting a lower CO<sub>2</sub>, O<sub>2</sub> or humidity setpoint, the gas or humidity must be able to escape first. Open both chamber doors for this purpose. Observe the precautions when working with gases (chap. 1.9).

## 7.1 Set-point entry through the “Setpoints” menu

 Press the **Setpoint setting** icon to access the “Setpoint” setting menu from Normal display.

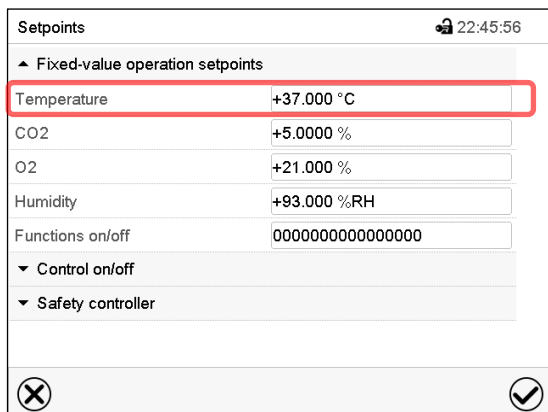

“Setpoints” menu.

Select “Fixed value operation setpoints” to access the individual parameters.

- Select the field “Temperature” and enter the desired temperature setpoint.  
Setting range: 20 °C up to 60 °C. Confirm entry with **Confirm** icon.
- Select the field “CO<sub>2</sub>” and enter the desired CO<sub>2</sub> setpoint.  
Setting range: 0 vol.-% up to 20 vol.-%.  
Confirm entry with **Confirm** icon.

*Chamber with O<sub>2</sub> control:*

- Select the field “O<sub>2</sub>” and enter the desired O<sub>2</sub> setpoint.  
Setting range with regular hypoxic control range: 0.2 vol.-% up to 20 vol.-%.  
Setting range with alternative control range: 5 vol.-% up to 90 vol.-%.  
Confirm entry with **Confirm** icon.

*CBF / CBF-UL:*

- Select the field “Humidity” and enter the desired humidity setpoint.  
Setting range: 50 % r.h. up to 95 % r.h. Confirm entry with **Confirm** icon.



When entering a humidity setpoint value > 90 % r.h. a message window appears, indicating that condensation is possible. Press the **Confirm** icon.



When entering a setpoint value outside the setting range, the message: “Value outside of limits! (Min: xxx, Max: xxx)” appears (xxx is a wildcard for the limits of the respective parameter). Press the **Confirm** icon and repeat the entry with a correct value.

After completing the settings, press the **Confirm** icon to take over the entries and exit the menu, **or** press the **Close** icon to exit the menu without taking over the entries.

## 7.2 Direct setpoint entry via Normal display

Alternatively you can also enter the setpoints directly via Normal display.

Fixed value		22:37:16	
		Setpoint	Actual value
Temperature	°C	37.0	37.0
CO2	%	5.0	5.0
O2	%	21.0	21.0
Humidity	%RH	93.0	93.0

Normal display. Select the setpoint you want to change.



Fixed value		22:41:50	
Temperature			
<input type="text" value="37.000"/>			37.000
+20.000...+60.000			
7	8	9	
4	5	6	
1	2	3	
0	±	.	C

Example: "Temperature" entry menu. Enter the desired setpoint and confirm entry with **Confirm** icon.



When entering a humidity setpoint value > 90 % r.h. a message window appears, indicating that condensation is possible. Press the **Confirm** icon.

### 7.3 Special controller functions via operation lines

 Press the **Setpoint setting** icon to access the “Setpoint” setting menu from Normal display.

You can define the switching state of up to 16 operation lines (control contacts). They are used to activate / deactivate special controller functions.

*Chamber with O<sub>2</sub> control:* Depending on the required range of O<sub>2</sub> concentration, the type of gas which is required may vary (chap. 6.6). Therefore, the pressure alarms for O<sub>2</sub> and N<sub>2</sub> can be deactivated individually with active O<sub>2</sub> control.

For chambers equipped with the optional interior socket (chap. 18.4) you can turn on and off the voltage of the interior socket via the controller.

- Operation line “Idle mode” activates / deactivates the operating mode “Idle mode”.
- Operation line “O<sub>2</sub> pressure alarm off” activates / deactivates the O<sub>2</sub> pressure alarm (chamber with O<sub>2</sub> control and optional alternative control range)
- Operation line “N<sub>2</sub> pressure alarm off” activates / deactivates the N<sub>2</sub> pressure alarm (chamber with O<sub>2</sub> control)
- Operation line “Interior socket” activates / deactivates interior socket (option, available via BINDER INDIVIDUAL Customized Solutions)

The other operation lines are without function.

Use the “Setpoints” menu to configure the operation lines.

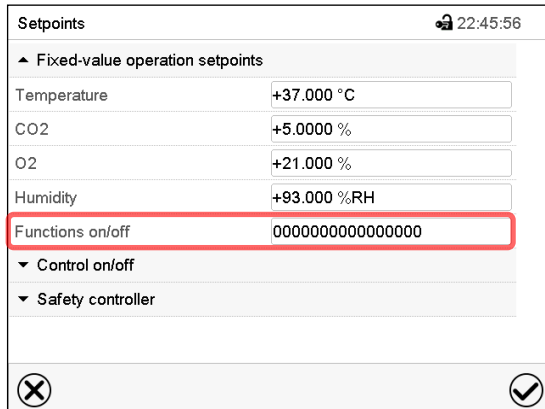

Setpoints	
▲ Fixed-value operation setpoints	
Temperature	+37.000 °C
CO <sub>2</sub>	+5.0000 %
O <sub>2</sub>	+21.000 %
Humidity	+93.000 %RH
Functions on/off	0000000000000000
▼ Control on/off	
▼ Safety controller	

“Setpoints” menu.

Select the field “Functions on/off”.

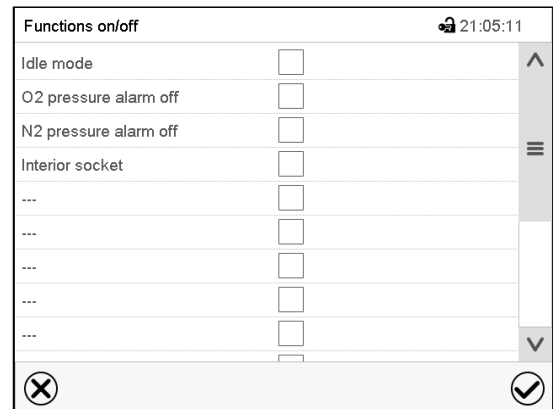
Functions on/off	
Idle mode	<input type="checkbox"/>
O <sub>2</sub> pressure alarm off	<input type="checkbox"/>
N <sub>2</sub> pressure alarm off	<input type="checkbox"/>
Interior socket	<input type="checkbox"/>
...	<input type="checkbox"/>
...	<input type="checkbox"/>
...	<input type="checkbox"/>
...	<input type="checkbox"/>
...	<input type="checkbox"/>
...	<input type="checkbox"/>

“Functions on/off” entry menu (view with

chamber with O<sub>2</sub> control with optional interior socket).

Mark / unmark the checkbox to activate / deactivate the desired function and press the **Confirm** icon

Activated operation line: switching status “1” (On)

Deactivated operation line: switching status “0” (Off)

The operation lines count from right to left.

#### Example:



Activated operation line “Idle mode” = 0000000000000000**1**

Deactivated operation line “Idle mode” = 0000000000000000**0**

## 7.4 Safety instructions for setting high gas concentrations

### Notes on handling carbon dioxide (CO<sub>2</sub>)



Carbon dioxide (CO<sub>2</sub>) in high concentrations is hazardous to health. It is colorless and almost odorless and therefore practically imperceptible. Vent out any CO<sub>2</sub> gas that may escape via good room ventilation or a suitable connection to an exhaust system. We recommend installing a CO<sub>2</sub> warning system.

	 <b>DANGER</b>
	<p><b>Danger of suffocation and poisoning by high concentration of CO<sub>2</sub> (&gt; 4 Vol.-%).</b>  <b>Death by suffocation.</b></p> <ul style="list-style-type: none"> <li>⊘ Do NOT set up chambers in non-ventilated recesses.</li> <li>➤ Ensure technical ventilation measures.</li> <li>➤ Observe the relevant regulations for handling CO<sub>2</sub>.</li> <li>➤ Close the CO<sub>2</sub> supply when decommissioning the chamber.</li> </ul>

If CO<sub>2</sub> is released, leave the area and inform the security service or fire department.

### Chamber with O<sub>2</sub> control: Notes on handling oxygen (O<sub>2</sub>)

Oxygen (O<sub>2</sub>) is colorless and almost odorless and therefore practically imperceptible. It promotes burns, which can proceed explosively. There is a fire hazard for flammable oxygenated materials, e.g. clothes and hair. O<sub>2</sub> is heavier than air and may accumulate in low-lying areas.



	 <b>DANGER</b>
	<p><b>Danger of fire and explosion through contact of combustible materials with O<sub>2</sub> with high concentration of O<sub>2</sub> (&gt; 21 % O<sub>2</sub>).</b>  <b>Serious injury or death from burns and / or explosion pressure.</b></p> <ul style="list-style-type: none"> <li>⊘ Do NOT set up chambers in non-ventilated recesses.</li> <li>➤ Ensure technical ventilation measures.</li> <li>➤ Observe the relevant regulations for handling O<sub>2</sub>.</li> <li>➤ Close the O<sub>2</sub> supply when decommissioning the chamber.</li> </ul>

Take appropriate measures to prevent oxygen enrichment and fire and explosion hazards in areas where oxygen enrichment is possible.

Observe the general information for safe handling of oxygen (chap. 1.9).

### Chamber with O<sub>2</sub> control: Notes on handling nitrogen (N<sub>2</sub>)

Nitrogen (N<sub>2</sub>) in high concentrations is hazardous to health. It is colorless and almost odorless and therefore practically imperceptible. Any N<sub>2</sub> gas that may escape must be safely led out via good room ventilation or a suitable connection to an exhaust system.

	 <b>DANGER</b>
	<p><b>Risk of suffocation through high concentration of N<sub>2</sub>.</b>  <b>Death by suffocation.</b></p> <ul style="list-style-type: none"> <li>⊘ Do NOT set up chambers in non-ventilated recesses.</li> <li>➤ Ensure technical ventilation measures.</li> <li>➤ Observe the relevant regulations for handling N<sub>2</sub>.</li> <li>➤ Close the N<sub>2</sub> supply when decommissioning the chamber.</li> </ul>

## 8. Timer program: stopwatch function

During an entered duration the controller constantly equilibrates to the setpoints entered in Fixed value operation mode (temperature, CO<sub>2</sub>, O<sub>2</sub> (chamber with O<sub>2</sub> control), humidity (CBF / CBF-UL), configuration of the operation lines). This duration can be entered as a “Timer program”. During the program runtime, any setpoint changes do not become effective; the controller equilibrates to the values which were active during program start.

### 8.1 Starting a timer program

 In Normal display press the **Program start** icon to access the “Program start” menu.

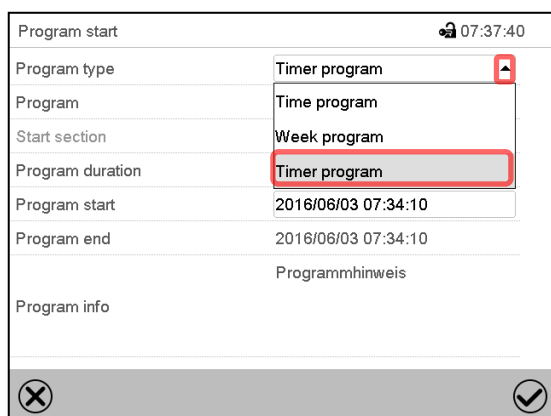

“Program start” menu

- In the field “Program type” select “Timer program”.
- Select the field “Program duration” and enter the desired program duration. Press the **Confirm** icon.
- Select the field “Program start” and enter the desired start time of the program in the “Program start” entry menu. Press the **Confirm** icon. The program delay time until program start begins.



Normal display.

Information on the bottom of the screen indicates the currently running program and the time already passed. The grey bar shows how much time of the whole time is elapsed.

#### 8.1.1 Performance during program delay time

During the configured program delay time until program start, the controller equilibrates to the current setpoints of Fixed value operation mode. Modifications of these setpoints are possible but become effective only after the timer program is finished. When the configured moment for program start is reached, the program delay time ends and the program starts running. The controller equilibrates to the values which had been active during program start

### 8.2 Cancelling a running timer program

 Press the **Program cancelling** icon to cancel the program.

A confirmation prompt is displayed. Press the **Confirm** icon to confirm that the program shall really be cancelled.

After confirming the message the controller changes to Fixed value operation mode. The chamber will then equilibrate to the setpoints of Fixed value operation mode.

### 8.3 Performance after the end of the program

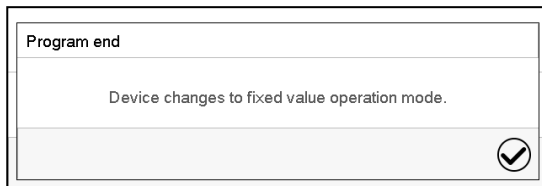

After the end of the program the message “Device changes to fixed value operation mode” appears on the screen.

Press the **Confirm** icon.

After confirming the message the controller changes to Fixed value operation mode. Temperature and humidity will then equilibrate to the setpoints of Fixed value operation mode.

## 9. Time programs

The MB2 program controller permits programming time programs with real-time reference. It offers 25 program memory positions with up to 100 program sections each.

For each program section you can enter set-points for temperature, CO<sub>2</sub>, O<sub>2</sub> (chamber with O<sub>2</sub> control), and humidity (CBF / CBF-UL), section duration, type of set-point transition (ramp or step) and the tolerance ranges.



If the safety controller has been set to “limit” mode, check the setting of the safety controller when changing the temperature set-point, (chap. 12.2).

Programming remains saved in case of a power failure or after turning off the unit.

Path: [Main menu](#) > [Programs](#) > [Time program](#)

### 9.1 Starting an existing time program



In Normal display press the **Program start** icon to access the “Program start” menu.

Program start		🔒 20:40:01
Program type	Time program	▼
Program	Sterilisation	▼
Start section	1	
Program duration		
Program start	2015/02/08 20:39:51	
Program end	2015/02/08 20:40:07	
Program info		
<div style="display: flex; justify-content: space-between;"> <span>✕</span> <span>✓</span> </div>		

“Program start” menu

- In the field “Program type” select the setting “Time program”.
- In the field “Program” select the desired program.
- Select the field “Program start” and enter the desired program start time in the “Program start” entry menu. Press the **Confirm** icon. The program delay time until program start begins.

The program end is adapted automatically depending on the entered program duration.

After completing the settings, press the **Confirm** icon to take over the entries and exit the menu. The program starts running.

If instead you press the **Close** icon to exit the menu without taking over the entries, the program will not start.



Normal display. Information on the bottom of the screen indicates the currently running program and the time already passed. The grey bar shows how much time of the whole time is elapsed. If program duration has been set to infinite, the grey bar is not displayed.

### 9.1.1 Performance during program delay time

During the configured program delay time until program start, the controller equilibrates to the current setpoints of Fixed value operation mode. Modifications of these setpoints are effective. When the configured moment for program start is reached, the program delay time ends and the program starts running.

## 9.2 Stopping a running time program

### 9.2.1 Pausing a running time program

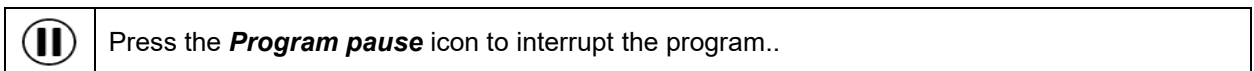

The program is paused. The program runtime stops running down, the time display flashes.

There are the following options:

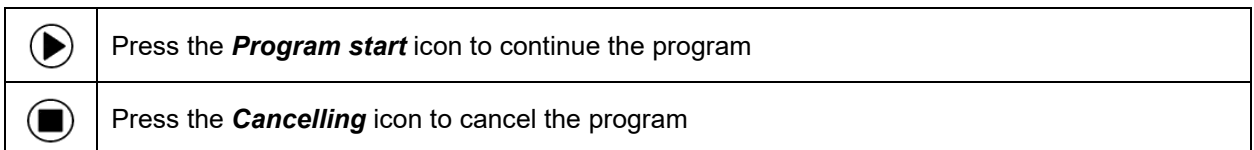

### 9.2.2 Cancelling a running time program

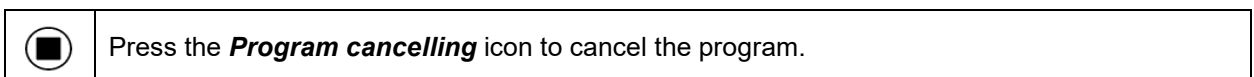

A confirmation prompt is displayed. Press the **Confirm** icon to confirm that the program shall really be cancelled.

After confirming the message, the controller changes to Fixed value operation mode. All values will then equilibrate to the setpoints of Fixed value operation mode.

## 9.3 Performance after the end of the program

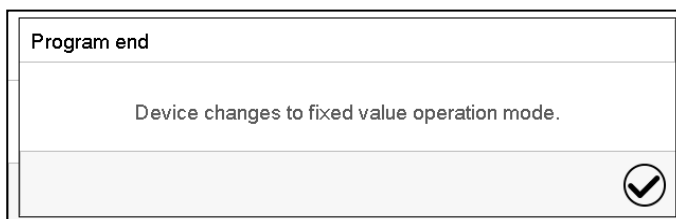

After the end of the program the message "Device changes to fixed value operation mode" appears on the screen. Press the **Confirm** icon.

As long as the message has not been confirmed, the setpoint of the last program section remains effective. Program the last section as desired. If the heating, CO<sub>2</sub> control, O<sub>2</sub> control (chamber with O<sub>2</sub> control) and humidification (CBF / CBF-UL) shall turn off, activate operation line "Idle mode" in the last program section.

After confirming the message the controller changes to Fixed value operation mode. The setpoints of Fixed value operation mode are then equilibrated.



## 9.4 Creating a new time program

Path: [Main menu > Programs > Time program](#)

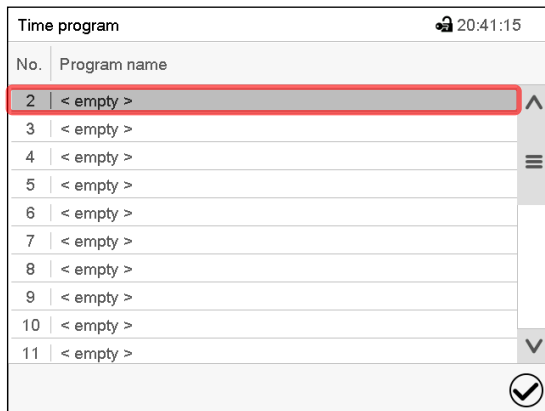

“Time program” menu:  
overview of the existing programs.  
Select an empty program place.

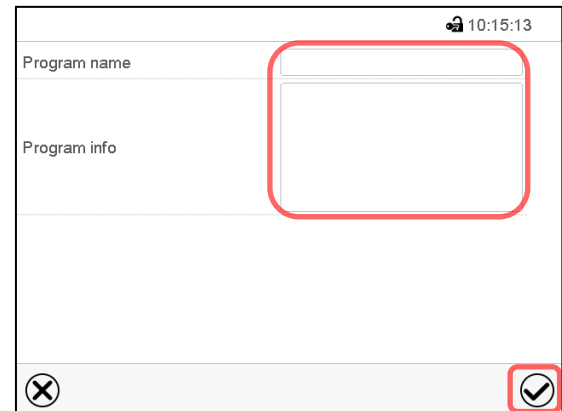

Enter the program name and, if desired,  
additional program information in the  
corresponding fields.  
Press the **Confirm** icon.  
The program view opens (chap. 9.5).

## 9.5 Program editor: program management

Path: [Main menu > Programs > Time program](#)

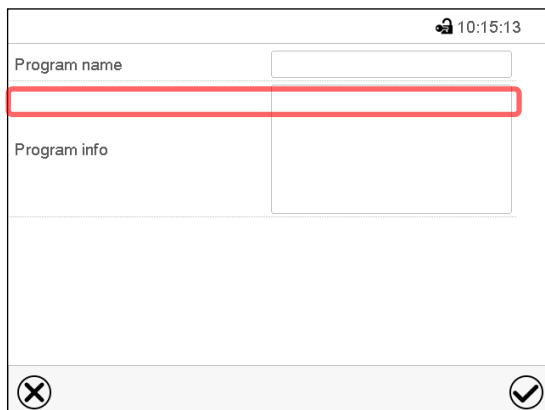

“Time program” menu:  
overview of the existing programs.  
Select an existing program (example: program  
3) or create a new program (chap. 9.4).  
The program view opens.

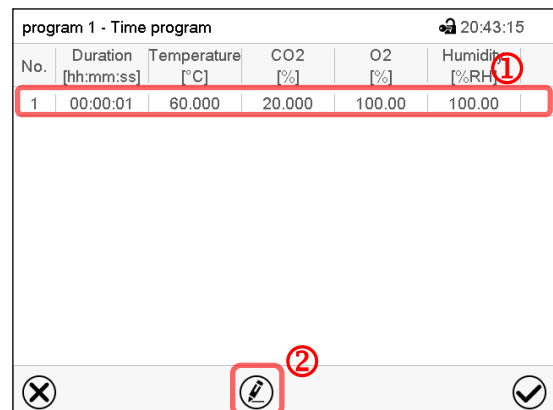

Program view (example: program 1).  
If a new program has been created, there is  
just one program section.

There are the following options:

- ① Select a program section to open the  
section editor (chap. 9.6)
- ② Press the **Edit** icon to open the program  
editor

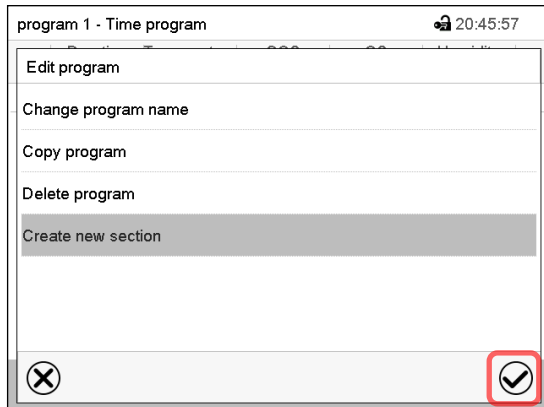

Program editor: “Edit program” menu

Select the desired function and press the **Confirm** icon.

The program editor offers following options:

- Change the program name
- Copy program
- Replace program: Replacing an new or an existing program with the copied program. This menu point is visible only after a program has been copied.
- Delete program
- Create new section

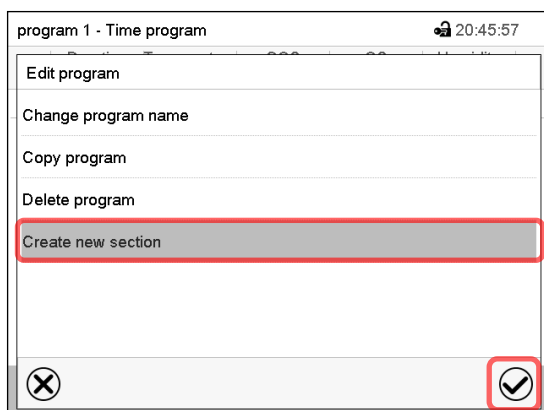

To add a new section, select “Create new section” and press the **Confirm** icon.

The program view opens.

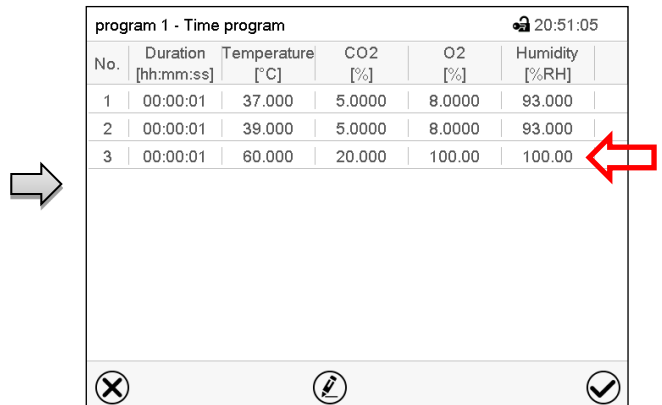

No.	Duration [hh:mm:ss]	Temperature [°C]	CO2 [%]	O2 [%]	Humidity [%RH]
1	00:00:01	37.000	5.0000	8.0000	93.000
2	00:00:01	39.000	5.0000	8.0000	93.000
3	00:00:01	60.000	20.000	100.00	100.00

Program view.

A new section is always added at the very bottom (example: section 3).

### 9.5.1 Deleting a time program

Path: [Main menu](#) > [Programs](#) > [Time program](#)

In the “Time program” menu select the program to be deleted. The program view opens.



In the **program view** press the **Edit** icon to open the program editor



In the **program editor** select “Delete program” and press the **Confirm** icon.

The program is deleted. The controller returns to the program view.

## 9.6 Section editor: section management

Path: [Main menu](#) > [Programs](#) > [Time program](#)

Select the desired program.

No.	Duration [hh:mm:ss]	Temperature [°C]	CO2 [%]	O2 [%]	Humidity [%RH]
1	00:00:01	37.000	5.0000	8.0000	93.000
2	00:00:01	39.000	5.0000	8.0000	93.000
3	00:00:01	37.000	5.0000	8.0000	93.000

Program view.

Select the desired program section (example: section 1)

program 1 - Section number 1	
Duration	00:00:01
Course	Ramp
Functions on/off	0000000000000000
Number of repetitions	0
Start section for repetition	1
Temperature	+37.000
Tolerance band min.	+0.0000
Tolerance band max.	+0.0000
CO2	+5.0000

Section view (example: section 1).

There are the following options:

- ① Select a parameter to enter or modify the according value (chap. 9.7)
- ② Press the **Edit** icon to open the program editor

program 3 - Section number 1	
Edit section	
Copy section	
Delete section	
Add new section	

Section editor: "Edit section" menu

Select the desired function and press the **Confirm** icon.

The section editor offers following options:

- Copy section
- Replace section: Replacing an existing section with the copied section. This menu point is visible only after a section has been copied.
- Insert section: Adding the copied section. This menu point is visible only after a section has been copied.
- Delete section
- Add new section

### 9.6.1 Add a new program section

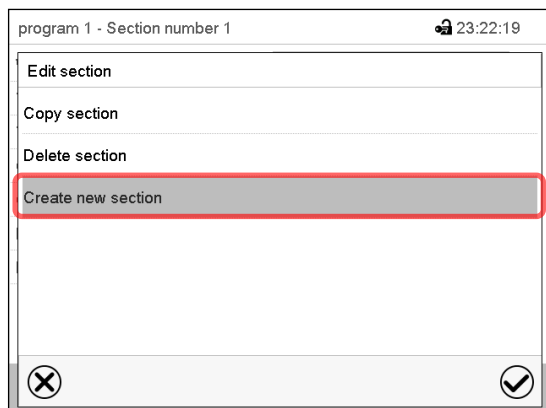

Section editor: "Edit section" menu.

Select "Create new section" and press the **Confirm** icon.

Then select whether to insert the new section before or after the current section.

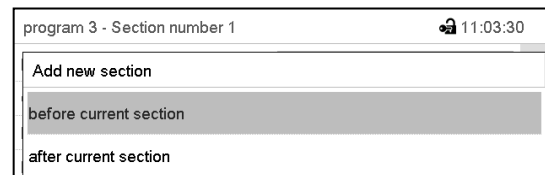

Press the **Confirm** icon. The new section opens.

### 9.6.2 Copy and insert or replace a program section

No.	Duration [hh:mm:ss]	Temperature [°C]	CO2 [%]	O2 [%]	Humidity [%RH]
1	00:00:01	37.000	5.0000	8.0000	93.000
2	00:00:01	39.000	5.0000	8.0000	93.000
3	00:00:01	37.000	5.0000	8.0000	93.000

Program view.

Select the program section to be copied (example: section 1)

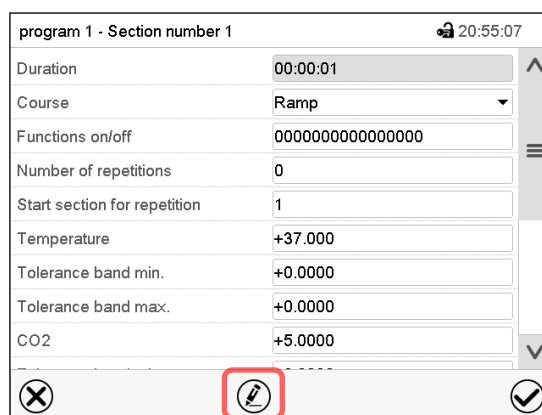

Section view (example: section 1).

Press the **Edit** icon to open the section editor.

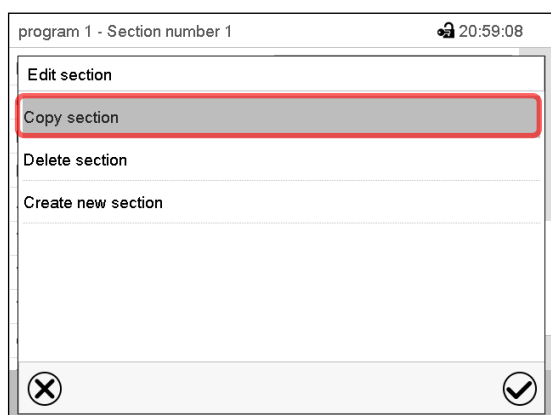

Section editor: "Edit section" menu

Select "Copy section" and press the **Confirm** icon.

The current section (example: section 1) is copied.

The controller returns to the section view.

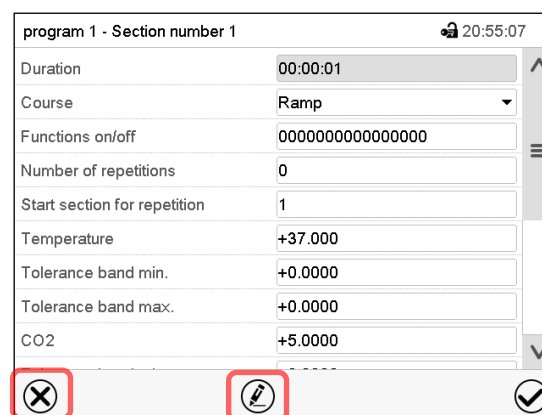

Section view (example: section 1).

Press the **Close** icon to change to the program view, if you want to select another section to be replaced or before or after which the copied section shall be inserted...

or

Press the **Edit** icon to open the section editor if you want the current section to be replaced or the copied section to be inserted before or after it

No.	Duration [hh:mm:ss]	Temperature [°C]	CO2 [%]	O2 [%]	Humidity [%RH]
1	00:00:01	37.000	5.0000	8.0000	93.000
2	00:00:01	39.000	5.0000	8.0000	93.000
3	00:00:01	37.000	5.0000	8.0000	93.000

Program view.

Select the section to be replaced or before or after which the copied section shall be inserted (example: section 3) and press the **Confirm** icon.

program 1 - Section number 1		20:55:07
Duration	00:00:01	↑
Course	Ramp	↓
Functions on/off	0000000000000000	☰
Number of repetitions	0	
Start section for repetition	1	
Temperature	+37.000	
Tolerance band min.	+0.0000	
Tolerance band max.	+0.0000	
CO2	+5.0000	↓

Section view (example: section 1).

Press the **Edit** icon to open the section editor

program 1 - Section number 1		21:00:40
Edit section		
Copy section		
Replace section		
Insert section		
Delete section		
Create new section		

Section editor: "Edit section" menu

Select "Replace section" to replace the selected section with the copied section

or

Select "Insert section" to additionally add the copied section.

In this case select whether to insert it before or after the selected section.

Insert section
before current section
after current section

Press the **Confirm** icon

### 9.6.3 Deleting a program section

In the **program view** select the program section to be deleted. The section view opens.



In the **section view** press the **Edit** icon to open the section editor



In the **section editor** select "Delete section" and press the **Confirm** icon.

The section is deleted. The controller returns to the section view.

## 9.7 Value entry for a program section

Path: [Main menu > Programs > Time program](#)

Select the desired program and section.

The section view gives access to all parameters of a program section. You can enter or modify the values.

<p>program 1 - Section number 1 <span style="float: right;">🔒 17:23:34</span></p> <p>Duration <input type="text" value="00:00:01"/> ^</p> <p>Course <input type="text" value="Ramp"/> v</p> <p>Functions on/off <input type="text" value="0000000000000000"/></p> <p>Number of repetitions <input type="text" value="0"/></p> <p>Start section for repetition <input type="text" value="1"/></p> <p>Temperature <input type="text" value="+60.000"/></p> <p>Tolerance band min. <input type="text" value="+0.0000"/></p> <p>Tolerance band max. <input type="text" value="+0.0000"/></p> <p>CO2 <input type="text" value="+20.000"/></p> <p>Tolerance band min. <input type="text" value="+0.0000"/></p> <p>Tolerance band max. <input type="text" value="+0.0000"/></p> <p>O2 <input type="text" value="+21.000"/></p> <p>Tolerance band min. <input type="text" value="+0.0000"/></p> <p>Tolerance band max. <input type="text" value="+0.0000"/></p> <p>Humidity <input type="text" value="+95.000"/> v</p> <p>⊗ <input type="text"/> ⊗ ⊗</p>	<p>Program name and section number</p> <p>Section duration</p> <p>Type of setpoint transition: ramp or step</p> <p>Operation lines</p> <p>Repeating one or several sections within a program</p> <p>Temperature setpoint</p> <p>Temperature tolerance range: minimum and maximum</p> <p>CO<sub>2</sub> setpoint</p> <p>CO<sub>2</sub> tolerance range: minimum and maximum</p> <p>O<sub>2</sub> setpoint (chamber with O<sub>2</sub> control)</p> <p>O<sub>2</sub> tolerance range: minimum and maximum</p> <p>Humidity setpoint (CBF / CBF-UL)</p>
--	---

The setting and control ranges for the individual parameters are the same as for “Fixed value” operating mode (chap. 7).

### 9.7.1 Section duration

program 3 - Section number 1 🔒 10:58:07

Duration  ^

Section view (partial view).

Select the field “Duration” indicating the time.

program 3 - Section number 2 🔒 11:14:19

Duration

:  :   
 :  :   
 (hh:mm:ss)

⊗  ⊗ ⊗

“Duration” entry menu.

Enter the desired section duration with the arrow keys and press the **Confirm** icon.

Setting range: 0 up to 99 hours 59 min 59 sec.

## 9.7.2 Set-point ramp and set-point step

You can define the type of transitions for temperature, CO<sub>2</sub> concentration, O<sub>2</sub> concentration (chamber with O<sub>2</sub> control) and humidity (CBF / CBF-UL) for each individual program section.

### “Ramp” mode: Gradual set-points changes

The set-point of a given program section functions as the section’s start value. During the section’s duration, each set-point gradually passes to the set-point of the subsequent program section. The actual value follows the continually changing set-point.

If the last program section is in “ramp” mode and the setpoint shall change within this section, then you must program an additional section (with the shortest possible section duration) to provide the target value of the last program section. Otherwise, the setpoint would remain constant during the section’s duration.

Programming in the “ramp” mode allows all kinds of temperature and CO<sub>2</sub> / O<sub>2</sub> and humidity transitions:

- Gradual changes of temperature and CO<sub>2</sub> / O<sub>2</sub> concentration and humidity  
The setpoint changes its value gradually during the entered section duration. The actual value follows the continually moving set-point at any time.
- Program sections with constant temperature and CO<sub>2</sub> / O<sub>2</sub> concentration and humidity  
The setpoints (initial values) of two subsequent program sections are identical; so the temperature, CO<sub>2</sub> / O<sub>2</sub> and humidity remain constant during the entire duration of the first program section.
- Sudden changes of temperature and CO<sub>2</sub> / O<sub>2</sub> concentration and humidity  
Steps can be programmed in ramp mode as temperature / CO<sub>2</sub> / O<sub>2</sub> / humidity changes (ramps) that occur during a very short interval. If the duration of this transitional program section is very short (minimum entry 1 sec), the temperature, CO<sub>2</sub> / O<sub>2</sub> or humidity change will proceed rapidly within the minimum amount of time.

### “Step” mode: Sudden set-points changes

The set-point of any program section functions as the section’s target value. At the start of the program section, heating up, attaining the set gas concentration and humidification occur with the maximum speed to reach the set-point values and then remain constant for the remaining section time. Therefore the set-points remain constant for the section’s duration. These changes occur rapidly within the minimum amount of time (minimum entry: 1 second).

Programming in the “step” mode allows only two kinds of temperature / CO<sub>2</sub> / O<sub>2</sub> / humidity transitions:

- Programming gradual changes of temperature / CO<sub>2</sub> / O<sub>2</sub> / humidity (ramps) is impossible in the “step” mode
- Program sections with constant temperature and CO<sub>2</sub> / O<sub>2</sub> concentration and humidity  
The setpoints (target values) of two subsequent program sections are identical; so the temperature / CO<sub>2</sub> / O<sub>2</sub> / humidity remain constant during the entire duration of the first program section.
- Sudden changes of temperature and CO<sub>2</sub> / O<sub>2</sub> concentration and humidity  
The entered setpoint of the section is reached as fast as possible and then held constant for the remaining section duration.

### Selecting the setting “Ramp” or “Step”

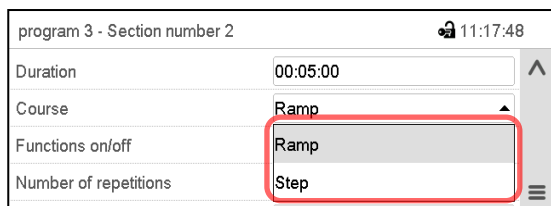

Section view (partial view).

In the field “Course” select the desired setting “Ramp” or “Step”.

### “Ramp” and “Step” mode example (representation of a temperature course)

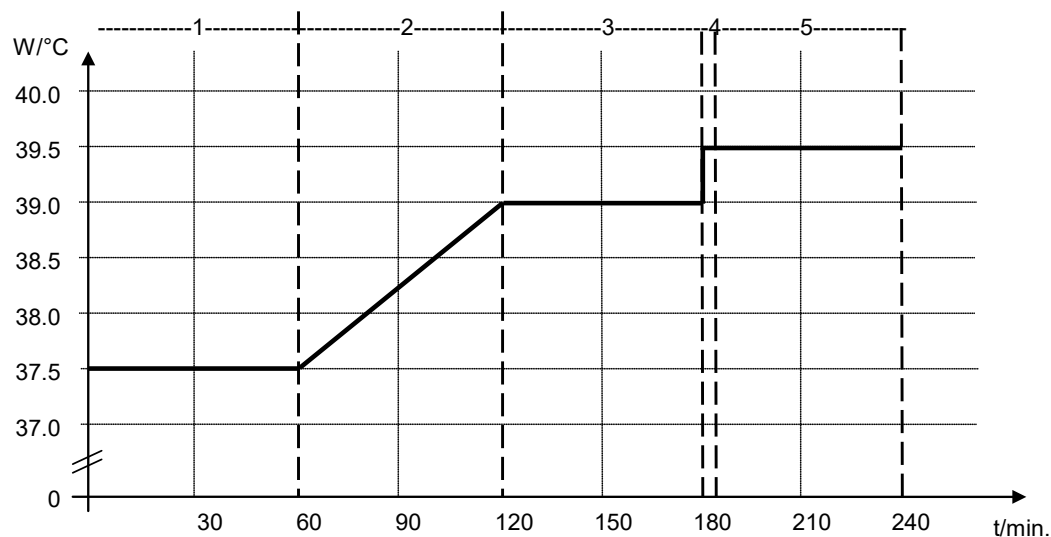

### Corresponding program table

Section No.	Duration [hh:mm:ss]	Temperature [°C]	CO2 [Vol.-%]	O2 [Vol.-%]	Humidity [% rH]	Ramp or Step
1	01:00:00	37.5	xxxx	xxxx	xxxx	Step
2	01:00:00	37.5	xxxx	xxxx	xxxx	Ramp
3	01:00:00	39.0	xxxx	xxxx	xxxx	Step
4	00:00:10	39.5	xxxx	xxxx	xxxx	Step
5	01:00:00	39.5	xxxx	xxxx	xxxx	Step



### 9.7.3 Special controller functions via operation lines

You can define the switching state of up to 16 operation lines (control contacts). They are used to activate / deactivate special controller functions.

*Chamber with O<sub>2</sub> control:* Depending on the required range of O<sub>2</sub> concentration, the type of gas which is required may vary (chap. 6.6). Therefore, the pressure alarms for O<sub>2</sub> and N<sub>2</sub> can be deactivated individually with active O<sub>2</sub> control.

For chambers equipped with the optional interior socket (chap. 18.4) you can turn on and off the voltage of the interior socket via the controller.

- Operation line “Idle mode” activates / deactivates the operating mode “Idle mode”.
- Operation line “O<sub>2</sub> pressure alarm off” activates / deactivates the O<sub>2</sub> pressure alarm (chamber with O<sub>2</sub> control and optional alternative control range)
- Operation line “N<sub>2</sub> pressure alarm off” activates / deactivates the N<sub>2</sub> pressure alarm (chamber with O<sub>2</sub> control)
- Operation line “Interior socket” activates / deactivates interior socket (option, available via BINDER INDIVIDUAL Customized Solutions)

The other operation lines are without function.

Use the Section editor to configure the operation lines.

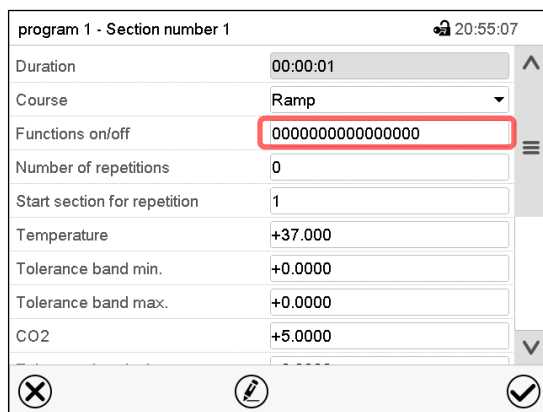

program 1 - Section number 1 20:55:07

Duration 00:00:01

Course Ramp

Functions on/off 0000000000000000

Number of repetitions 0

Start section for repetition 1

Temperature +37.000

Tolerance band min. +0.0000

Tolerance band max. +0.0000

CO2 +5.0000

Section view.

Select the field “Functions on/off”.



Functions on/off 21:05:11

Idle mode

O<sub>2</sub> pressure alarm off

N<sub>2</sub> pressure alarm off

Interior socket

...

...

...

...

...

...

“Functions on/off” entry menu (view with chamber with O<sub>2</sub> control with optional interior socket).

Mark / unmark the checkbox of the desired function to activate / deactivate it and press the Confirm icon.

The controller returns to the section view.

Activated operation line: switching status “1” (On)

Deactivated operation line: switching status “0” (Off)

The operation lines count from right to left.

#### Example:

Activated operation line “Idle mode” = 00000000000000001

Deactivated operation line “Idle mode” = 00000000000000000

### 9.7.4 Setpoint entry

- Select the field “Temperature” and enter the desired temperature setpoint.  
Setting range: 20 °C up to 60 °C.  
Confirm entry with **Confirm** icon. The controller returns to the section view.
- Select the field “CO<sub>2</sub>” and enter the desired CO<sub>2</sub> setpoint.  
Setting range: 0 vol.-% up to 20 vol.-%.  
Confirm entry with **Confirm** icon. The controller returns to the section view.

*Chamber with O<sub>2</sub> control:*

- Select the field “O<sub>2</sub>” and enter the desired O<sub>2</sub> setpoint.  
Setting range with regular hypoxic control range: 0.2 vol.-% up to 20 vol.-%.  
Setting range with alternative control range: 5 vol.-% up to 90 vol.-%.  
Confirm entry with **Confirm** icon. The controller returns to the section view.

CBF / CBF-UL:

- Select the field “Humidity” and enter the desired humidity setpoint.  
Setting range: 50 % r.h. up to 95 % r.h.  
Confirm entry with **Confirm** icon. The controller returns to the section view.

### 9.7.5 Tolerance range

You can specify tolerance ranges for temperature, CO<sub>2</sub> and O<sub>2</sub> (chamber with O<sub>2</sub> control) and humidity (CBF / CBF-UL) for each program section with different values for the tolerance minimum and maximum. When the actual value exceeds the given threshold, the program is interrupted. This is indicated on the display (see below). When the actual temperature is situated again within the entered tolerance limits, the program automatically continues. Therefore, the duration of the program may be extended due to the programming of tolerances.



Programming of tolerances may extend program duration.

An entry of “-99999” for the tolerance minimum means “minus infinite” and an entry of “999999” for the tolerance maximum means “plus infinite”. Entry of these values will never lead to program interruption. The entry of “0” for the tolerance minimum and/or maximum deactivates the respective tolerance function.

When requesting rapid value transitions, we recommend not programming tolerance values in order to enable the maximum speed for heating-up and CO<sub>2</sub> / O<sub>2</sub> control, and humidification.

program 1 - Section number 1		🕒 20:55:07
Duration	00:00:01	⬆
Course	Ramp	⬇
Functions on/off	0000000000000000	☰
Number of repetitions	0	
Start section for repetition	1	
Temperature	+37.000	
Tolerance band min.	+0.0000	
Tolerance band max.	+0.0000	
CO <sub>2</sub>	+5.0000	⬇

Section view, showing the temperature tolerance band

- Select the field “Tolerance band min” and enter the desired lower tolerance band value. Setting range: -99999 to 99999. Confirm entry with **Confirm** icon. The controller returns to the section view.
- Select the field “Tolerance band max” and enter the desired upper tolerance band value. Setting range: -99999 to 99999. Confirm entry with **Confirm** icon. The controller returns to the section view.

Set the tolerance ranges for other parameters accordingly, if desired.

If one of the actual values (temperature, CO<sub>2</sub>, O<sub>2</sub>, humidity) is outside the program tolerance range the whole program course is interrupted. During this program interruption time the controller equilibrates to the set-points of the current section.

The screen header indicates “Program pause (tolerance band)”. The program runtime indication flashes and does not proceed any further.

When the temperature or CO<sub>2</sub> / O<sub>2</sub> or humidity values are back within the entered program tolerance range, the program continues automatically.

### 9.7.6 Repeating one or several sections within a time program

You can repeat several subsequent sections together. It is not possible to define the start section the same time also as the target section, therefore you cannot repeat a single individual section.

Enter the desired number of repetitions in the field „Number of repetitions“ and the number of the section to start the repetition cycle with in the field “Start section for repetition” To have sections repeated infinitely, enter the number of repetitions as “-1”.

The selected sections are repeated as many times as selected. Then the program continues.

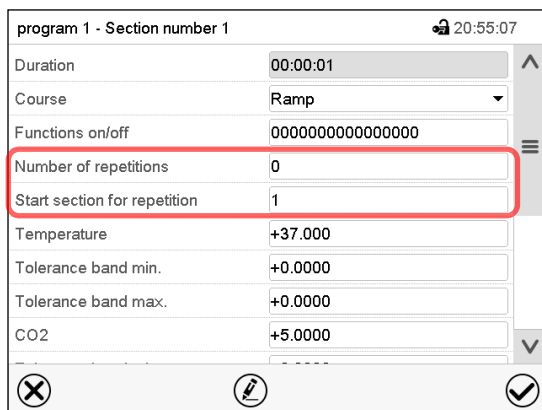

Section view, showing the repetition function

- Select the field “Number of repetitions” and enter the desired number of repetitions. Setting range: 1 to 99, and -1 for infinite. Confirm entry with Confirm icon. The controller returns to the section view.
- Select the field “Start section for repetition” and enter the section number, at which the repetition should start. Setting range: 1 up to the section before the currently selected section. Confirm entry with **Confirm** icon. The controller returns to the section view.

### 9.7.7 Saving the time program

program 1 - Section number 1 🔒 20:55:07

Duration	00:00:01
Course	Ramp
Functions on/off	0000000000000000
Number of repetitions	0
Start section for repetition	1
Temperature	+37.000
Tolerance band min.	+0.0000
Tolerance band max.	+0.0000
CO2	+5.0000

⌕ ⌵

⊗ ✎ ✔

Section view.

After the all desired values of the program section have been configured, press the **Confirm** icon to take over the programming. The controller changes to the program view.



program 1 - Time program 🔒 20:51:05

No.	Duration [hh:mm:ss]	Temperature [°C]	CO2 [%]	O2 [%]	Humidity [%RH]
1	00:00:01	37.000	5.0000	8.0000	93.000
2	00:00:01	39.000	5.0000	8.0000	93.000
3	00:00:01	60.000	20.000	100.00	100.00

⌕ ⌵

⊗ ✎ ✔

Program view.

Press the **Confirm** icon to take over the programming. The controller changes to the Normal display.

To save the programming it is absolutely required to press the **Confirm** icon. Otherwise all settings will be lost! There is no confirmation prompt!

## 10. Week programs

The MB2 program controller permits programming week programs with real-time reference. It offers 5 week program places in total with up to 100 shift points for each week program.

Path: [Main menu](#) > [Programs](#) > [Week program](#)

### 10.1 Starting an existing week program

In Normal display press the **Program start** icon to access the “Program start” menu.

Program start 🔒 20:40:01

Program type	Time program
Program	Sterilisation
Start section	1
Program duration	
Program start	2015/02/08 20:39:51
Program end	2015/02/08 20:40:07
Program info	

⌕ ⌵

⊗ ✎ ✔

“Program start” menu.

- In the field “Program type” select the setting “Week program”.
- In the field “Program” select the desired program.
- There are no further settings available in the “Program start” menu for week programs, as they are needed only for time programs.

After completing the settings, press the **Confirm** icon to take over the entries and exit the menu. The program starts running.

If instead you press the **Close** icon to exit the menu without taking over the entries, the program will not start.

After starting the week program, the previously entered week program setpoints are active and will be equilibrated according to the current time.



Information on the bottom of the screen indicates the currently running program.

## 10.2 Cancelling a running week program

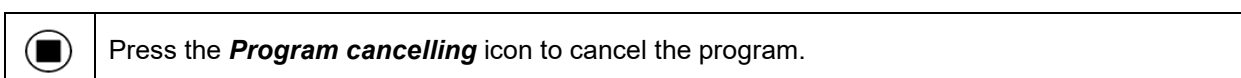

A confirmation prompt is displayed. Press the **Confirm** icon to confirm that the program shall really be cancelled.

After confirming the message the controller changes to Fixed value operation mode. The chamber will then equilibrate to the setpoints of Fixed value operation mode.

## 10.3 Creating a new week program

Path: [Main menu](#) > [Programs](#) > [Week program](#)

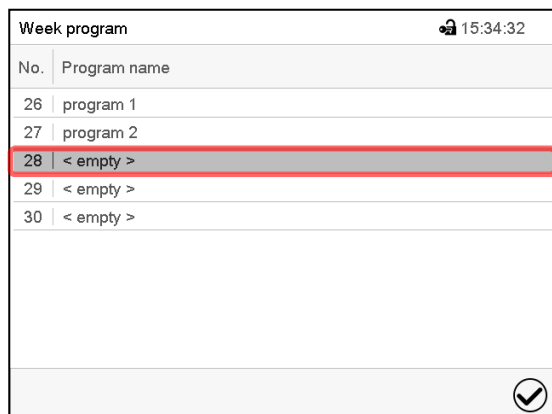

“Week program” menu:  
overview of the existing programs.  
Select an empty program place.

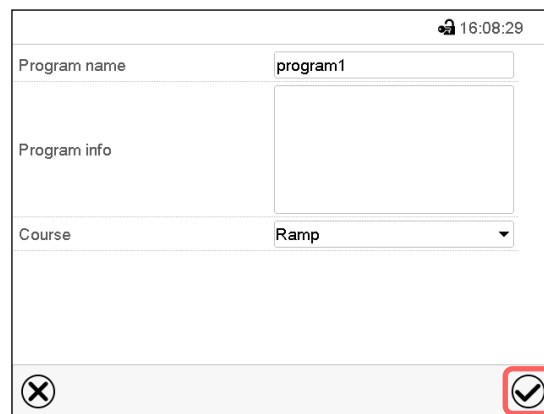

Enter the program name and, if desired, additional program information in the corresponding fields.  
Select the set-point course “Ramp” or “Step” (chap. 10.6.1).  
Press the **Confirm** icon. The program view opens.



program 1 - Week program 🔒 18:34:46

No.	Weekday	Time [hh:mm:ss]	Temperature [°C]	CO2 [%]	O2 [%]
1	No day	00:00:01	60.000	20.000	21.000

✕    ✎    ✓

Program view.

For the first section no weekday is specified. Therefore the section is first marked in red and cannot be saved.

## 10.4 Program editor: program management

Path: [Main menu](#) > [Programs](#) > [Week program](#)

Week program 🔒 08:39:23

No.	Program name
26	program 1
27	program 2
28	< empty >
29	< empty >
30	< empty >

✓

“Week program” menu: overview of the existing programs. Select an existing program (example: program 1).

program 1 - Time program 🔒 23:00:01

No.	Weekday	Time [hh:mm:ss]	Temperature [°C]	CO2 [%]	O2 [%]
1	Monday	03:00:00	37.000	5.0000	8.0000
2	Tuesday	00:00:01	39.000	8.0000	100.00

✕    ✎    ✓

Program view (example: program 1).

If a new program has been created, there is just one program section.

There are the following options:

- ① Select a program section to open the section editor (chap. 10.4.1)
- ② Press the **Edit** icon to open the program editor

program 1 - Week program 🔒 15:43:30

Edit program

Change program name

Copy program

Delete program

Create new section

✕    ✓

Program editor: “Edit program” menu.

Select the desired function and press the **Confirm** icon.

The program editor offers following options:

- Change program name. This menu also offers to configure the ramp / step mode setting (chap. 10.6.1).
- Copy program
- Replace program: Replacing an new or an existing program with the copied program. This menu point is visible only after a section has been copied.
- Delete program
- Create new section

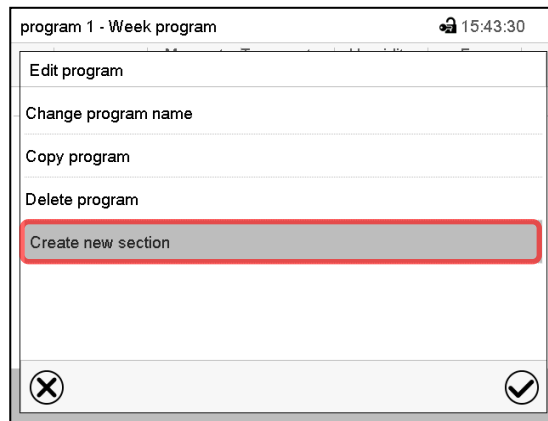

To add a new section, select “Create new section” and press the **Confirm** icon.  
The program view opens.

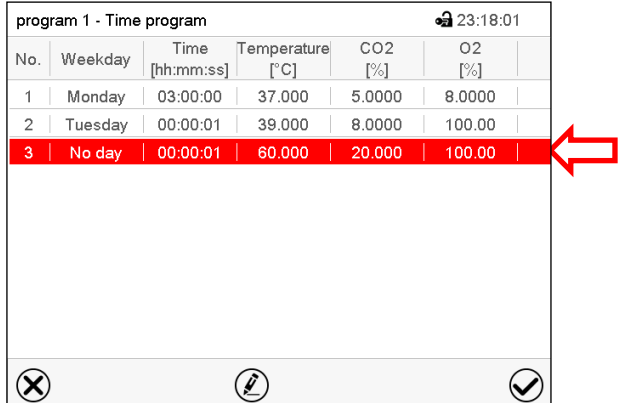

No.	Weekday	Time [hh:mm:ss]	Temperature [°C]	CO2 [%]	O2 [%]
1	Monday	03:00:00	37.000	5.0000	8.0000
2	Tuesday	00:00:01	39.000	8.0000	100.00
3	No day	00:00:01	60.000	20.000	100.00

Program view.

With a new section no weekday is specified. Therefore the section is first marked in red and cannot be saved.

A new section is always added at the very bottom (example: section 3). When the section start is specified the sections are automatically arranged in the correct chronological order.

#### 10.4.1 Deleting a week program

Path: [Main menu](#) > [Programs](#) > [Week program](#)

In the “Week program” menu select the program to be deleted. The program view opens.



In the **program view** press the **Edit** icon to open the program editor



In the **program editor** select “Delete program” and press the **Confirm** icon.  
The program is deleted. The controller returns to the program view.

## 10.5 Section editor: section management

Path: [Main menu](#) > [Programs](#) > [Week program](#)

Select the desired program.

No.	Weekday	Time [hh:mm:ss]	Temperature [°C]	CO2 [%]	O2 [%]
1	Monday	03:00:00	37.000	5.0000	8.0000
2	Tuesday	00:00:01	39.000	8.0000	100.00

Program view.

Select the desired program section (example: section 1)

program 1 - Section number 1		22:58:41
Weekday	Monday	
Time	03:00:00	①
Temperature	+37.000	
CO2	+5.0000	
O2	+8.0000	
Humidity	+93.000	
Functions on/off	0000000000000000	

Section view (example: section 1).

There are the following options:

- ① Select a parameter to enter or modify the according value (chap. 10.6)
- ② Press the **Edit** icon to open the program editor

program 1 - Section number 1		23:22:19
Edit section		
Copy section		
Delete section		
Create new section		

Section editor: "Edit section" menu

Select the desired function and press the **Confirm** icon.

The section editor offers following options:

- Copy section
- Replace section: Replacing an existing section with the copied section. This menu point is visible only after a section has been copied.
- Insert section: Adding the copied section. This menu point is visible only after a section has been copied.
- Delete section
- Create new section



### 10.5.1 Add a new program section

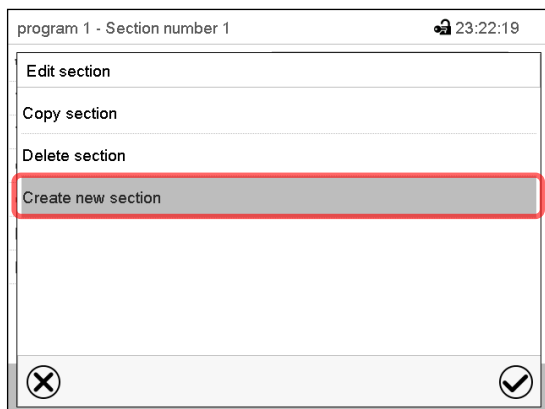

Section editor: “Edit section” menu.

Select “Create new section” and press the **Confirm** icon.

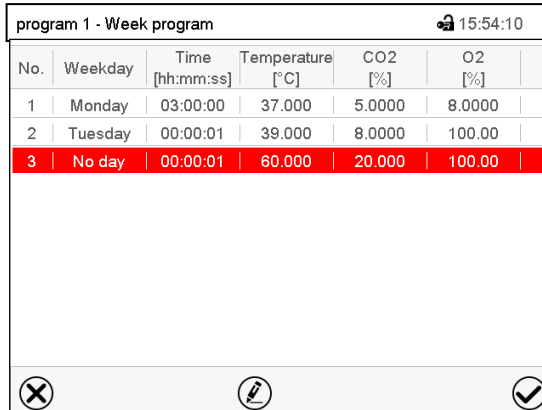
No.	Weekday	Time [hh:mm:ss]	Temperature [°C]	CO2 [%]	O2 [%]
1	Monday	03:00:00	37.000	5.0000	8.0000
2	Tuesday	00:00:01	39.000	8.0000	100.00
3	No day	00:00:01	60.000	20.000	100.00

Program view.

With a new section no weekday is specified. Therefore the section is first marked in red and cannot be saved.

A new section is always added at the very bottom (example: section 3). When the section start is specified the sections are automatically arranged in the correct chronological order.

### 10.5.2 Copy and insert or replace a program section

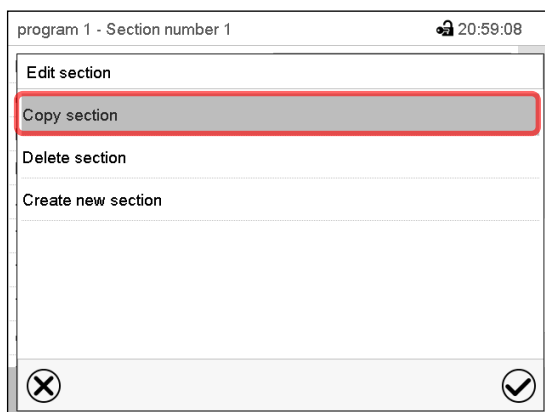

Section editor: “Edit section” menu

Select “Copy section” and press the **Confirm** icon.

The current section (example: section 1) is copied.

The controller returns to the program view.

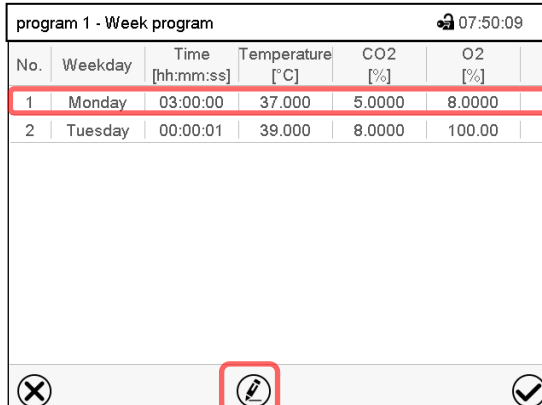
No.	Weekday	Time [hh:mm:ss]	Temperature [°C]	CO2 [%]	O2 [%]
1	Monday	03:00:00	37.000	5.0000	8.0000
2	Tuesday	00:00:01	39.000	8.0000	100.00

Program view

Select the section to be replaced or before or after which the copied section shall be inserted (example: section 1).

Press the **Confirm** icon

The controller returns to the section editor



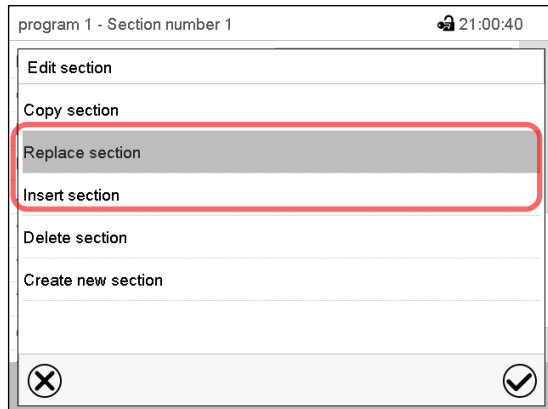

Section editor: “Edit section” menu

Select “Replace section” to replace the selected section with the copied section

or

Select “Insert section” to additionally add the copied section.

Press the **Confirm** icon.

If you selected “Insert section” the sections are automatically arranged in the correct chronological order.

### 10.5.3 Deleting a program section

In the **program view** select the program section to be deleted. The section view opens.



In the **section view** press the **Edit** icon to open the section editor



In the **section editor** select “Delete section” and press the **Confirm** icon.

The section is deleted. The controller returns to the section view.

## 10.6 Value entry for a program section

Path: [Main menu](#) > [Programs](#) > [Week program](#)

Select the desired program and section.

The setting and control ranges for the individual parameters are the same as for “Fixed value” operating mode (chap. 7).

### 10.6.1 Set-point ramp and set-point step modes

**The explanation of the settings “Ramp” or “Step” is given in chap. 9.7.2.**

You can define the type of transitions for temperature, CO<sub>2</sub> concentration, O<sub>2</sub> concentration (chamber with O<sub>2</sub> control) and humidity (CBF / CBF-UL) for the entire week program.

Select the desired program and press the **Edit** icon to open the program editor. In the program editor select the “Change program name” function and press the **Confirm** icon.

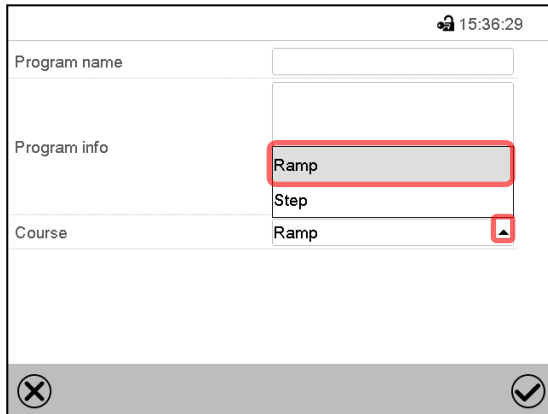

“Change program name” menu.

In the field “Course” select the desired setting “Ramp” or “Step” and press the **Confirm** icon.

### 10.6.2 Weekday

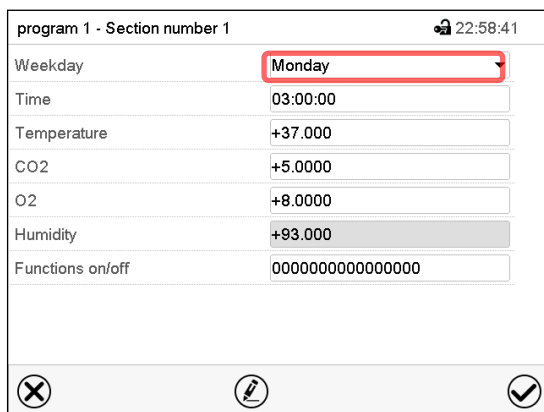

In the field “Weekday” select the desired weekday.

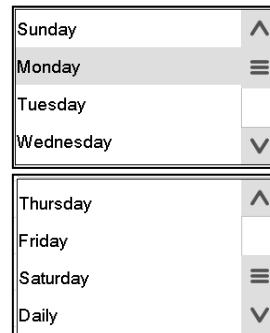

Section view.

With “Daily” selected, this section will run every day at the same time.

### 10.6.3 Start time

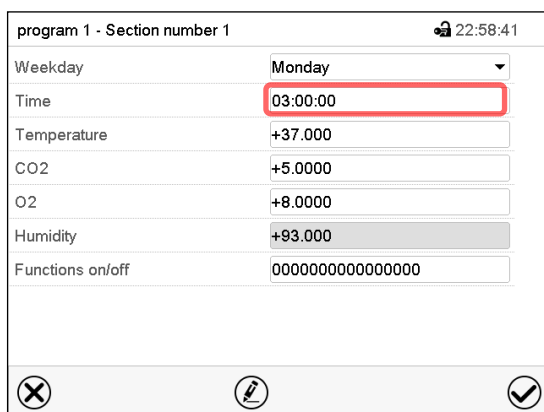

Section view.

Select the field “Moment”.

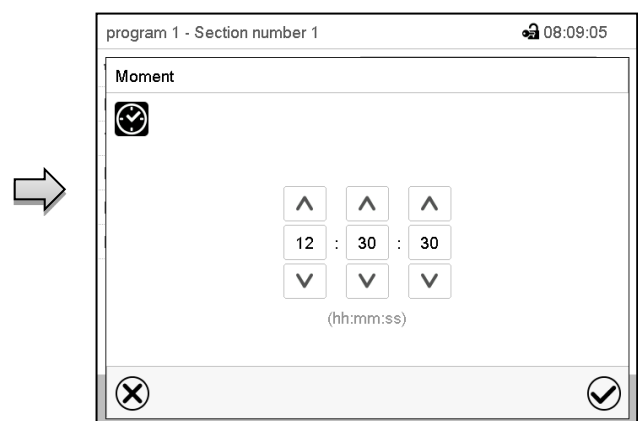

Entry menu “Moment”.

Select with the arrow keys the desired start moment of the section and press the **Confirm** icon.

#### 10.6.4 Setpoint entry

- Select the field “Temperature” and enter the desired temperature setpoint.  
Setting range: 20 °C up to 60 °C.  
Confirm entry with **Confirm** icon. The controller returns to the section view.
- Select the field “CO<sub>2</sub>” and enter the desired CO<sub>2</sub> setpoint.  
Setting range: 0 vol.-% up to 20 vol.-%.  
Confirm entry with **Confirm** icon. The controller returns to the section view.

*Chamber with O<sub>2</sub> control:*

- Select the field “O<sub>2</sub>” and enter the desired O<sub>2</sub> setpoint.  
Setting range with regular hypoxic control range: 0.2 vol.-% up to 20 vol.-%.  
Setting range with alternative control range: 5 vol.-% up to 90 vol.-%.  
Confirm entry with **Confirm** icon. The controller returns to the section view.

CBF / CBF-UL:

- Select the field “Humidity” and enter the desired humidity setpoint.  
Setting range: 50 % r.h. up to 95 % r.h.  
Confirm entry with **Confirm** icon. The controller returns to the section view.

#### 10.6.5 Special controller functions via operation lines

You can define the switching state of up to 16 operation lines (control contacts). They are used to activate / deactivate special controller functions.

*Chamber with O<sub>2</sub> control:* Depending on the required range of O<sub>2</sub> concentration, the type of gas which is required may vary (chap. 6.6). Therefore, the pressure alarms for O<sub>2</sub> and N<sub>2</sub> can be deactivated individually with active O<sub>2</sub> control.

For chambers equipped with the optional interior socket (chap. 18.4) you can turn on and off the voltage of the interior socket via the controller.

- Operation line “Idle mode” activates / deactivates the operating mode “Idle mode”.
- Operation line “O<sub>2</sub> pressure alarm off” activates / deactivates the O<sub>2</sub> pressure alarm (chamber with O<sub>2</sub> control and optional alternative control range)
- Operation line “N<sub>2</sub> pressure alarm off” activates / deactivates the N<sub>2</sub> pressure alarm (chamber with O<sub>2</sub> control)
- Operation line “Interior socket” activates / deactivates interior socket (option, available via BINDER INDIVIDUAL Customized Solutions)

The other operation lines are without function.

Select the desired program and section. You can set the operation lines in the “Functions on/off” field.

*For details please refer to chap. 9.7.3.*

## 11. Notification and alarm functions

### 11.1 Notification and alarm messages overview

#### 11.1.1 Notifications

Notifications are indicated by **information icons** displayed in the screen header in Normal display

An information icon serves as an indication of a certain condition.







If this condition persists, in some cases an alarm will be triggered after a fix or configurable interval. As long as the condition persists, the information icon therefore continues to be displayed also in state of alarm. If during alarm the conditions ends, e.g., if during a tolerance range alarm the actual value returns to within the tolerance range, the information icon disappears, whereas the alarm will continue until manual acknowledgement.

Press the flash icon next to the information icon to access the corresponding text information.



Normal display showing the text information.

The currently valid information texts are highlighted in black (example: "O2 pressure alarm off")

Condition	Information icon	Text information	Start after condition occurred
The controller is in Idle mode (chap. 5.4).		"Idle mode"	immediately
Chamber door open		"Door open"	immediately
CO <sub>2</sub> pressure alarm deactivated		"CO <sub>2</sub> pressure alarm off"	immediately
<i>Chamber with O<sub>2</sub> control and optional alternative control range:</i> O <sub>2</sub> pressure alarm deactivated		"O <sub>2</sub> pressure alarm off"	immediately
<i>Chamber with O<sub>2</sub> control:</i> N <sub>2</sub> pressure alarm deactivated		"N <sub>2</sub> pressure alarm off"	immediately
Interior socket (option) activated		"Interior socket"	immediately
Hot air sterilization running		"Sterilization"	immediately

Notifications are not shown in the event list.

### 11.1.2 Alarm messages

Condition	Alarm message	Start after condition occurred	Zero-voltage relay alarm output
<p>Having reached the setpoint, the actual temperature value deviates by more than the set tolerance range value and longer than the set delay time from the setpoint</p> <p><b>or</b></p> <p>the temperature doesn't reach the tolerance range within 3 hours from turning on the chamber or closing the door.</p>	"Temperature range"	After configurable delay time (chap. 11.5). Factory setting: 10 minutes	With alarm start
<p>Having reached the setpoint, the actual CO<sub>2</sub> concentration deviates by more than the set tolerance range value and longer than the set delay time from the setpoint</p> <p><b>or</b></p> <p>the CO<sub>2</sub> concentration doesn't reach the tolerance range within 3 hours from turning on the chamber or closing the door</p>	"CO <sub>2</sub> range"	After configurable delay time (chap. 11.5). Factory setting: 10 minutes	With alarm start
<p><i>Chamber with O<sub>2</sub> control:</i></p> <p>Having reached the setpoint, the actual O<sub>2</sub> concentration deviates by more than the set tolerance range value and longer than the set delay time from the setpoint</p> <p><b>or</b></p> <p>the O<sub>2</sub> concentration doesn't reach the tolerance range within 3 hours from turning on the chamber or closing the door</p>	"O <sub>2</sub> range"	After configurable delay time (chap. 11.5). Factory setting: 10 minutes	With alarm start
<p><b>CBF / CBF-UL:</b></p> <p>Having reached the setpoint, the actual humidity value deviates by more than the set tolerance range value and longer than the set delay time from the setpoint</p> <p><b>or</b></p> <p>the humidity doesn't reach the tolerance range within 3 hours from turning on the chamber or closing the door.</p>	"Humidity range"	After configurable delay time (chap. 11.5). Factory setting: 10 minutes	With alarm start
Chamber door is open for longer than the set delay time.	"Door open"	After configurable delay time (chap. 11.5). Factory setting: 1 minute	----
Power failure	---	----	immediately

Condition	Alarm message	Start after condition occurred	Zero-voltage relay alarm output
Exceeded setpoint of the safety controller class 3.1	"Safety controller	immediately	----
Low CO <sub>2</sub> outlet pressure (< 0.3 bar / 4.4 psi)	"CO <sub>2</sub> pressure"	immediately	----
<i>Chamber with O<sub>2</sub> control:</i> Low O <sub>2</sub> outlet pressure (< 0.3 bar / 4.4 psi)	"O <sub>2</sub> pressure"	immediately	----
<i>Chamber with O<sub>2</sub> control:</i> Low N <sub>2</sub> outlet pressure (< 0.3 bar / 4.4 psi)	"N <sub>2</sub> pressure"	immediately	----
Temperature sensor defective	e.g. "----" or "<-<-<" or ">->->"	immediately	immediately
Safety controller temperature sensor defective	"Safety controller sensor"	immediately	immediately
Condensation on the CO <sub>2</sub> sensor head. Dry the filter cap (see chap. 22.6.4) <i>If after drying the message reappears:</i> CO <sub>2</sub> sensor may be defective. Contact BINDER Service.	"CO <sub>2</sub> sensor not ready"	immediately	----
Condensation on the CO <sub>2</sub> sensor head for longer than 6 hours. Dry the filter cap (see chap. 22.6.4) OR CO <sub>2</sub> sensor defective. Contact BINDER Service.	"CO <sub>2</sub> sensor fault"	immediately	immediately
<i>Chamber with O<sub>2</sub> control:</i> O <sub>2</sub> sensor defective. Contact BINDER Service	"O <sub>2</sub> sensor fault"	immediately	immediately
<b>CBF / CBF-UL:</b> Humidity sensor defective. Contact BINDER Service	"Humid sensor fault"	immediately	immediately
Hot air sterilization running	"Sterilization"	immediately	----
<b>CBF / CBF-UL:</b> Humidity module defective. Contact BINDER Service.	"Humidity system"	immediately	immediately
<b>CBF / CBF-UL:</b> Humidity module cannot fill up. Possible causes: <ul style="list-style-type: none"> <li>• Freshwater bag is empty or contains air</li> <li>• The silicon tube is not correctly inserted into the pump</li> <li>• Silicon tube kinked</li> </ul> Humidification turns off. When the water supply is functional again, the humidity system restarts, or the chamber is defective.	"Freshwater supply"	immediately	immediately

Alarm messages are displayed in the list of active alarms until acknowledging them. They are also shown in the event list.

	When operating the chamber without CO <sub>2</sub> / O <sub>2</sub> / N <sub>2</sub> connection, turn off the corresponding gas control in the “setpoints” menu (chap. 6.7) in order to avoid tolerance range and pressure alarms.
--	--

	CBF / CBF-UL: When operating the chamber without water supply, turn off humidity control in the “setpoints” menu (chap. 6.7) in order to avoid humidity alarms..
--	--

## 11.2 State of alarm

1. Visual indications in Normal display: alarm message, screen header flashing in red color
2. Audible alert, if the buzzer is enabled (chap. 11.4).
3. In some cases: Switching the zero-voltage relay alarm output (chap. 11.6) to transmit the alarm e.g., to a central monitoring system.

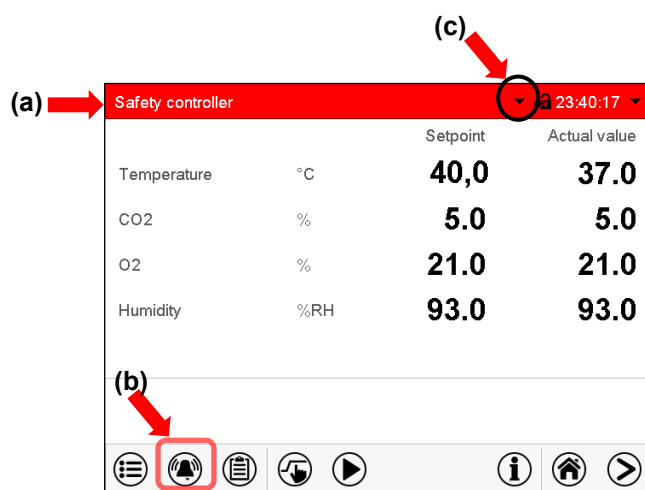

Normal display in state of alarm (example).

(a) Screen header flashing in red color and showing the alarm message

(b) **Alarm** icon on the bottom of the screen: change to the list of active alarms and alarm acknowledgement

(c) If applicable, information icon in the screen header. Indication of a certain condition

## 11.3 Resetting an alarm, list of active alarms

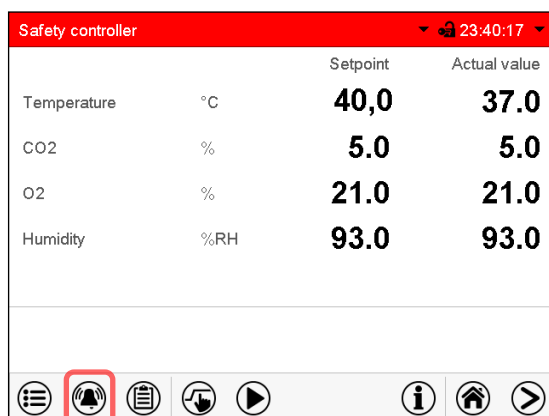

Normal display in state of alarm (example).

Press the **Alarm** icon

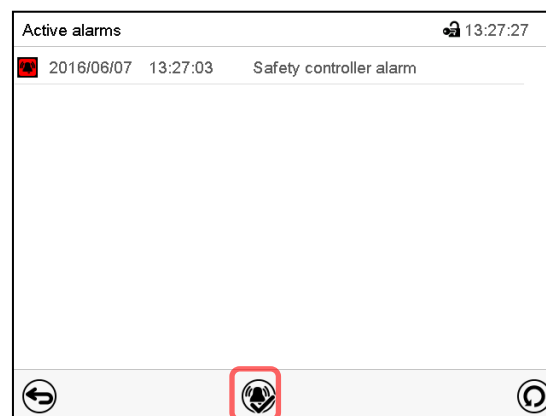

List of active alarms.

Press the **Reset alarm** icon.

Pressing the **Reset alarm** icon mutes the buzzer for all active alarms. The icon then disappears.

- Acknowledging while the alarm condition persists: Only the buzzer turns off. The visual alarm indication remains on the controller display. The alarm remains in the list of active alarms.



When the alarm condition has ended, the visual alarm indication is automatically cleared. The alarm is then no longer in the list of active alarms.

- Acknowledging after the alarm condition has ended: The buzzer and the visual alarm indication are reset together. The alarm is then no longer in the list of active alarms.
- The zero-voltage relay alarm output resets together with the alarm.

For appropriate actions in the event of an alarm, please refer to chap. 22.6 “Troubleshooting”.

## 11.4 Activating / deactivating the audible alarm (alarm buzzer)

Path: [Main menu](#) > [Settings](#) > [Chamber](#)

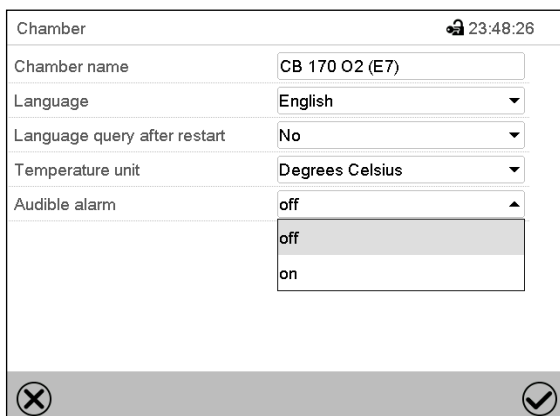

Chamber	
Chamber name	CB 170 O2 (E7)
Language	English
Language query after restart	No
Temperature unit	Degrees Celsius
Audible alarm	off
	off
	on

“Chamber” submenu (example).

In the field “Audible alarm” select the desired setting “off” or “on” and press the **Confirm** icon.

## 11.5 Tolerance range settings and alarm delay times

Path: [Main menu](#) > [Settings](#) > [Various](#)

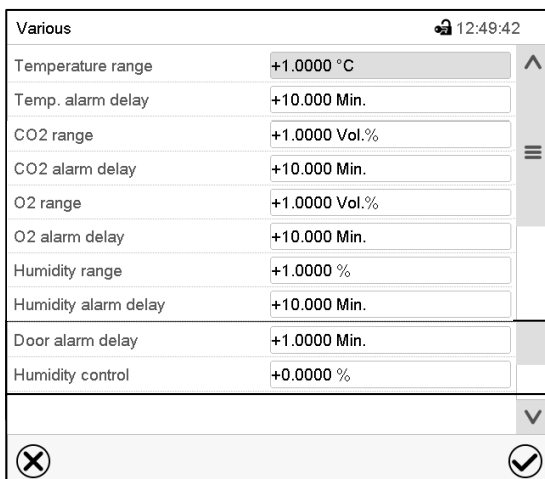

Various	
Temperature range	+1.0000 °C
Temp. alarm delay	+10.000 Min.
CO2 range	+1.0000 Vol.%
CO2 alarm delay	+10.000 Min.
O2 range	+1.0000 Vol.%
O2 alarm delay	+10.000 Min.
Humidity range	+1.0000 %
Humidity alarm delay	+10.000 Min.
Door alarm delay	+1.0000 Min.
Humidity control	+0.0000 %

Submenu “Various”.

Select the desired function.

In this menu you can set the deviation between the actual value and setpoint for temperature, CO<sub>2</sub>, O<sub>2</sub> (chamber with O<sub>2</sub> control) and humidity (CBF / CBF-UL) which shall cause a tolerance range alarm, and you can define the delay time after which the tolerance alarm will be triggered.

Also you can set the delay time after opening the door will trigger an alarm.

The entered value defines the tolerance range around the setpoint value. Example: Temperature setpoint: 37 °C, tolerance range value: +/- 2 °C, i.e. this defines a tolerance range from 35 °C up to 39 °C.

This function only activates after the set-point has been reached once.

### Alarms following deviations from the tolerance range or door opening

If the actual value, after having reached the setpoint, deviates by more than the set tolerance range value and longer than 10 min. from the setpoint **or** the temperature doesn't reach the tolerance range within 3 hours from turning on the chamber or closing the door, after the configured interval (e.g., "Temp range alarm delay") an alarm is triggered. It is visually indicated in Normal display. If the alarm buzzer is activated (chap. 11.4) there is an audible alert. The zero-voltage relay alarm output (chap. 11.6) switches to transmit the alarm. The alarm is shown in the list of active alarms (chap. 11.3).

Alarm message	Start after condition occurred
"Temperature range"	after configurable time
"CO2 range"	after configurable time
"O2 range"	after configurable time
"Humidity range"	after configurable time
"Door open"	after configurable time

If the condition (deviation from the tolerance range or door opening) ends within the configured alarm delay time, no alarm will be triggered after the delay time.

	<p>When operating the chamber with deactivated CO<sub>2</sub>, O<sub>2</sub> (chamber with O<sub>2</sub> control) or humidity (CBF / CBF-UL) control (chap. 6.7), the corresponding tolerance range alarms will not occur.</p>
---	--

#### Setting:

- Select the field "Temperature range" and enter the desired value for the temperature range. Setting range: 1 °C to 10 °C. Confirm entry with **Confirm** icon.
- Select the field "Temp alarm delay" and enter the time in minutes, after which the range alarm shall be triggered. Setting range: 1 min to 120 min. Confirm entry with Confirm icon.
- Select the field "CO<sub>2</sub> range" and enter the desired value for the CO<sub>2</sub> range. Setting range: 1 vol.-% to 10 vol.-%. Confirm entry with **Confirm** icon.
- Select the field "CO<sub>2</sub> alarm delay" and enter the time in minutes, after which the range alarm shall be triggered. Setting range: 1 min to 120 min. Confirm entry with Confirm icon.
- Select the field "O<sub>2</sub> range" and enter the desired value for the O<sub>2</sub> range. Setting range: 1 vol.-% to 10 vol.-%. Confirm entry with **Confirm** icon.
- Select the field "O<sub>2</sub> alarm delay" and enter the time in minutes, after which the range alarm shall be triggered. Setting range: 1 min to 120 min. Confirm entry with Confirm icon.
- Select the field "Humidity range" and enter the desired value for the humidity range. Setting range: 5% r.h. to 20% r.h. Confirm entry with **Confirm** icon.
- Select the field "Humid alarm delay" and enter the time in minutes, after which the range alarm shall be triggered. Setting range: 1 min to 120 min. Confirm entry with Confirm icon.
- Select the field "Door alarm delay" and enter the time in minutes, after which the range alarm shall be triggered. Setting range: 1 min to 120 min. Confirm entry with Confirm icon.

After completing the settings, press the **Confirm** icon to take over the entries and exit the menu, **or** press the **Close** icon to exit the menu without taking over the entries.

## 11.6 Zero-voltage relay alarm output

The chamber is equipped with a zero-voltage relay output which permits the transmission of some alarm messages to a central monitoring system.

The connection is realized as a DIN socket (3) on the chamber rear. A suitable DIN plug is enclosed.

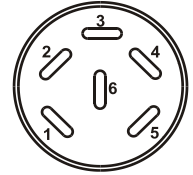
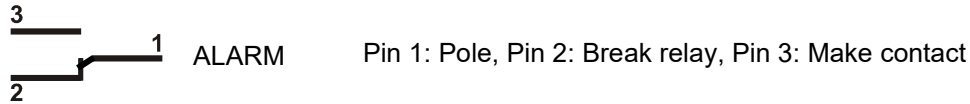



Figure 41: Pin configuration of the DIN socket (3) on the chamber rear



In case there is no alarm, contact 1 closes with contact 3.

Closing contact 1 with contact 2 switches the zero-voltage relay alarm output.

**Maximum loading capacity of the switching contacts: 24V AC/DC – 2.5A**

	 <b>DANGER</b>
	<p><b>Electrical hazard through overload of switching contacts.</b>  <b>Deadly electric shock. Damage to switching contacts and connection socket.</b></p> <ul style="list-style-type: none"> <li>⊘ Do NOT exceed the maximum switching load of 24V AC/DC – 2.5A.</li> <li>⊘ Do NOT connect any devices with a higher loading capacity.</li> </ul>

The zero-voltage relay alarm output switches at the following events:

Alarm message	Condition	Switching the alarm contact
---	Power failure	immediately
“Temperature range”	Temperature tolerance range alarm (see chap. 11.1.2)	After configurable delay time (chap. 11.5). Factory setting: 10 minutes
“CO2 range”	CO <sub>2</sub> tolerance range alarm (see chap. 11.1.2)	After configurable delay time (chap. 11.5). Factory setting: 10 minutes
“O2 range”	O <sub>2</sub> tolerance range alarm (chamber with O <sub>2</sub> control) (see chap. 11.1.2)	After configurable delay time (chap. 11.5). Factory setting: 10 minutes
<b>CBF / CBF-UL:</b> “Humidity range”	Humidity tolerance range alarm (see chap. 11.1.2)	After configurable delay time (chap. 11.5). Factory setting: 10 minutes
“Door open”	Chamber door open alarm (see chap. 11.1.2)	After configurable delay time (chap. 11.5). Factory setting: 1 minutes
<b>CBF / CBF-UL:</b> “Humidity system”	The humidity module is defective (see chap. 11.1.2)	immediately
<b>CBF / CBF-UL:</b> “Freshwater supply”	The humidity module cannot fill up (see chap. 11.1.2)	immediately

In case of a tolerance range alarm or a door open alarm, the alarm message on the controller display remains on during the alarm transmission via the zero-voltage relay outputs.

As soon as the cause of the alarm is identified and resolved, you can reset the alarm transmission via the zero-voltage relay outputs together with the alarm message in the “Active alarms” menu by pressing the **Reset alarm** icon.

In case of a power failure, transmission of the alarm via zero-voltage relay outputs remains active for the duration of the power failure. After power returns, contact 1 closes automatically with contact 3.



When using the APT-COM™ 4 Multi Management Software (option, chap. 18.1) for data acquisition, the alarm messages are only recorded in the protocol.

➤ Set the tolerance limits for limit alarms by APT-COM™ 4 separately in the AlarmCenter.

## 12. Temperature safety devices

### 12.1 Over temperature protective device (class 1)

The chamber is equipped with an internal temperature safety device, class 1 acc. to DIN 12880:2007. It serves to protect the chamber and prevents dangerous conditions caused by major defects.

If the actual temperature exceeds the nominal temperature by approx. 10 °C, the over temperature protective device permanently turns off the chamber. The user cannot restart the device again. The protective cut-off device is located internally. Only a service specialist can replace it. Therefore, please contact an authorized service provider or BINDER Service.

### 12.2 Overtemperature safety controller class 3.1

The chambers are regularly equipped with an electronic overtemperature safety controller (temperature safety device class 3.1 according to DIN 12880:2007). The safety controller is functionally and electrically independent of the temperature control system. If an error occurs, it performs a regulatory function.

Please observe the regulations applicable to your country (for Germany: DGUV guidelines 213-850 on safe working in laboratories, issued by the employers' liability insurance association).

The overtemperature safety controller serves to protect the chamber, its environment and the contents from exceeding the maximum permissible temperature. In the case of an error, it limits the temperature inside the chamber to the entered safety controller set-point. This condition (state of alarm) is indicated visually and additionally with an audible alert if the buzzer is enabled (chap. 11.4). The alarm persists until the chamber cools down below the configured safety controller setpoint.



Check the setting regularly and adjust it following changes of the set-point or charge.



During a running sterilization (chap. 21.3) the safety controller is non-functional

### 12.2.1 Safety controller modes

You can select between “Limit (absolute)” and “Offset (relative)” safety controller mode

- **Limit:** Absolute maximum permitted temperature value

This setting offers high safety as a defined temperature limit will not be exceeded. It is important to adapt the safety controller set-point after each modification of the temperature set-point. Otherwise, the limit could be too high to ensure efficient protection, or, in the opposite case, it could prevent the controller from reaching an entered set-point outside the limit range.

- **Offset:** Maximum overtemperature above any active temperature set point. The maximum temperature changes internally and automatically with every set-point change.

This setting is recommended for program operation. It is important to check the safety controller set-point and safety controller mode occasionally, as it does not offer a fix, independent limit temperature value, which would never be exceeded.

**Example:** Desired temperature value: 37 °C, desired safety controller value: 39 °C.  
Possible settings for this example:

Temperature set point	Safety controller mode	Safety controller set-point
37 °C	Limit (absolute)	39 °C
	Offset (relative)	2 °C

### 12.2.2 Setting the safety controller



Press the **Setpoint setting** icon to access the “Setpoint” setting menu from Normal display.

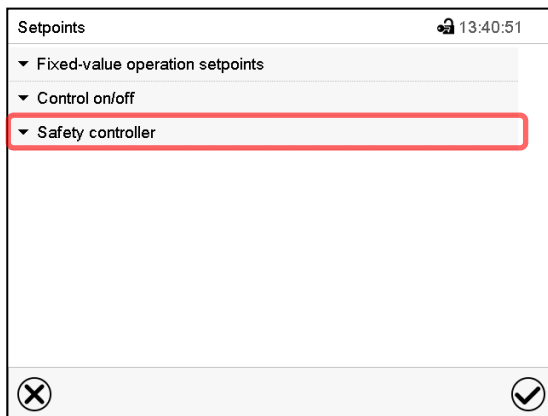

“Setpoints” menu.

Select the field “Safety controller” to access the settings.

- In the field “Mode” select the desired setting “Limit” or “Offset”.

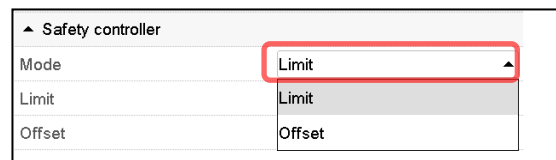

- Select the corresponding field “Limit” or “Offset” according to the selected mode and enter the desired safety controller setpoint. Confirm entry with Confirm icon.

	<p>Regularly check the safety controller setting for set-point type “Limit” or “Offset”</p> <ul style="list-style-type: none"> <li>• in Fixed value operating mode according to the entered set-point temperature value</li> <li>• in program mode according to the highest temperature value of the selected temperature program</li> </ul> <p>Set the safety controller set-point by approx. 2 °C above the desired temperature set-point.</p>
---	--

After completing the settings, press the **Confirm** icon to take over the entries and exit the menu, **or** press the **Close** icon to exit the menu without taking over the entries.

### 12.2.3 Message and measures in the state of alarm

The state of alarm is indicated visually in Normal display by the alarm message “Safety controller alarm” and the screen header flashing in red color. If the buzzer is enabled (chap. 11.4) there is an additional audible alert (chap. 11.2). The alarm remains active until it is acknowledged on the controller and the inner temperature falls below the set safety controller setpoint. Then the heating is released again.

Safety controller		Setpoint	Actual value
Temperature	°C	<b>40,0</b>	<b>37.0</b>
CO2	%	<b>5.0</b>	<b>5.0</b>
O2	%	<b>21.0</b>	<b>21.0</b>
Humidity	%RH	<b>93.0</b>	<b>93.0</b>

☰

📄
👉
▶
ℹ️
🏠
➡

Normal display with safety controller alarm.

Press the **Alarm** icon



Active alarms		13:27:27
	2016/06/07 13:27:03	Safety controller alarm

←

↻

List of active alarms.

Press the **Reset alarm** icon.

### 12.2.4 Function check

Check the safety controller at appropriate intervals for its functionality. It is recommended that the authorized operating personnel should perform such a check, e.g., before starting a longer work procedure.

## 13. User management

### 13.1 Authorization levels and password protection

The available functions depend on the current authorization level “Master”, “Service”, “Admin” or “User”.

The authorization levels are hierarchical: Every authorization includes all functions of the next lower level.

#### “Master” authorization level

- Highest authorization level, only for developers
- Extensive authorization for controller operation and configuration, outputs/inputs, alarm settings, parameter sets and operating ring display
- All passwords can be changed in the “log out” submenu (chap. 13.3).

#### “Service” authorization level

- Authorization level only for BINDER service
- Extensive authorization for controller operation and configuration, access to service data
- The passwords for “Service”, “Admin” and “User” authorization levels can be changed in the “log out” submenu (chap. 13.3).

#### “Admin” authorization level

- Expert authorization level, for the administrator
- Authorization for controller configuration and network settings and for operating those controller functions required for operating the chamber. Restricted access to service data.
- Password (factory setting): “2”.
- The passwords for “Admin” and “User” authorization levels can be changed in the “log out” submenu (chap. 13.3).

#### “User” authorization level

- Standard authorization level for the chamber operator
- Authorization for operating the controller functions required for operating the chamber.
- No authorization for controller configuration and network settings. The “Settings” and “Service” submenus of the main menu are not available.
- Password (factory setting): “1”
- The password for the “User” authorization level can be changed in the “log out” submenu (chap. 13.3).

As soon as a password has been assigned for an authorization level, the access to this level and the related controller functions are only available after log-in with the appropriate password.

If for an authorization level no password is assigned, the related controller functions of this level are available for every user without login.

If passwords have been assigned for all authorization levels, access to the controller functions is locked without login.

### Operation after user login

At user login, the authorization level is selected and confirmed by entering the respective password.

Following user login, controller operation is available, recognizable by the open-lock icon in the header. The available controller functions correspond to the user's authorization level.

Fixed value		Setpoint	Actual value
Temperature	°C	37.0	37.0
CO2	%	5.0	5.0
O2	%	21.0	21.0
Humidity	%RH	93.0	93.0



### Password protection activated for all levels: operation without user login is locked

If passwords have been assigned for all authorization levels, the controller is locked without registration of a user.

As long as no user is registered, controller operation is locked, recognizable at the closed-lock icon in the header. This requires that the user management has been activated by the assignment of passwords for the individual authorization levels.

Fixed value		Setpoint	Actual value
Temperature	°C	37.0	37.0
CO2	%	5.0	5.0
O2	%	21.0	21.0
Humidity	%RH	93.0	93.0



### Password protection for at least one level deactivated: operation without user login is possible

If passwords have not been assigned for all authorization levels, after turning on the chamber there are those controller functions available, which correspond to the highest authorization level without password protection.

No lock icon is shown in the display header.

User login is neither required nor possible.

To activate the password protection and user login, perform new password assignment (chap. 13.5.3).

Fixed value		Setpoint	Actual value
Temperature	°C	37.0	37.0
CO2	%	5.0	5.0
O2	%	21.0	21.0
Humidity	%RH	93.0	93.0

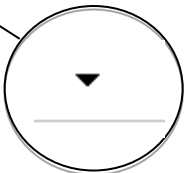



## Information window

To check the authorization level of the user currently logged-in, select in Normal display the arrow far right in the display header.

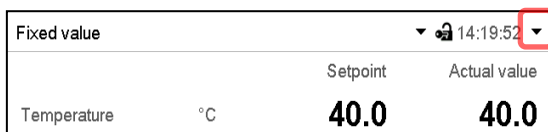

The information window shows date and time, the controller's free memory space and under "Authorization" the authorization level of the current user.

If passwords have been assigned for all authorization levels, a user without login (password entry) has no authorization. There are only viewing functions available.

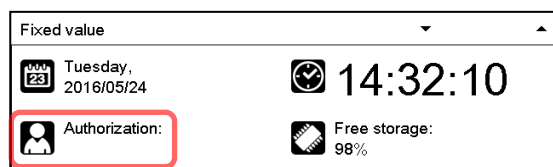

Display when all authorization levels are password protected and no user has logged in:  
No authorization level is displayed.

If passwords have been assigned only for some of the authorization levels, a user without login (password entry) has access to the functions of the highest authorization level without password protection.

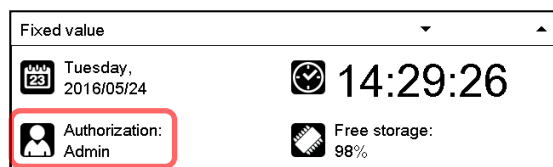

Display when only some of the authorization levels are password protected (example: no protection for the "User" and "Admin" levels) and no user has logged in:

The user's effective authorization (due to lack of password protection) is shown.

Example: user with "Admin" authorization.

If passwords have been assigned for some or all of the authorization levels, user login (password entry) provides the authorization for the corresponding password-protected level.



Display when at least some of the authorization levels are password protected and a user has logged in.

The user's authorization (by password entry) is shown.

Example: user with "Admin" authorization.

## 13.2 Log in

Path: **Main menu > User > Log in**

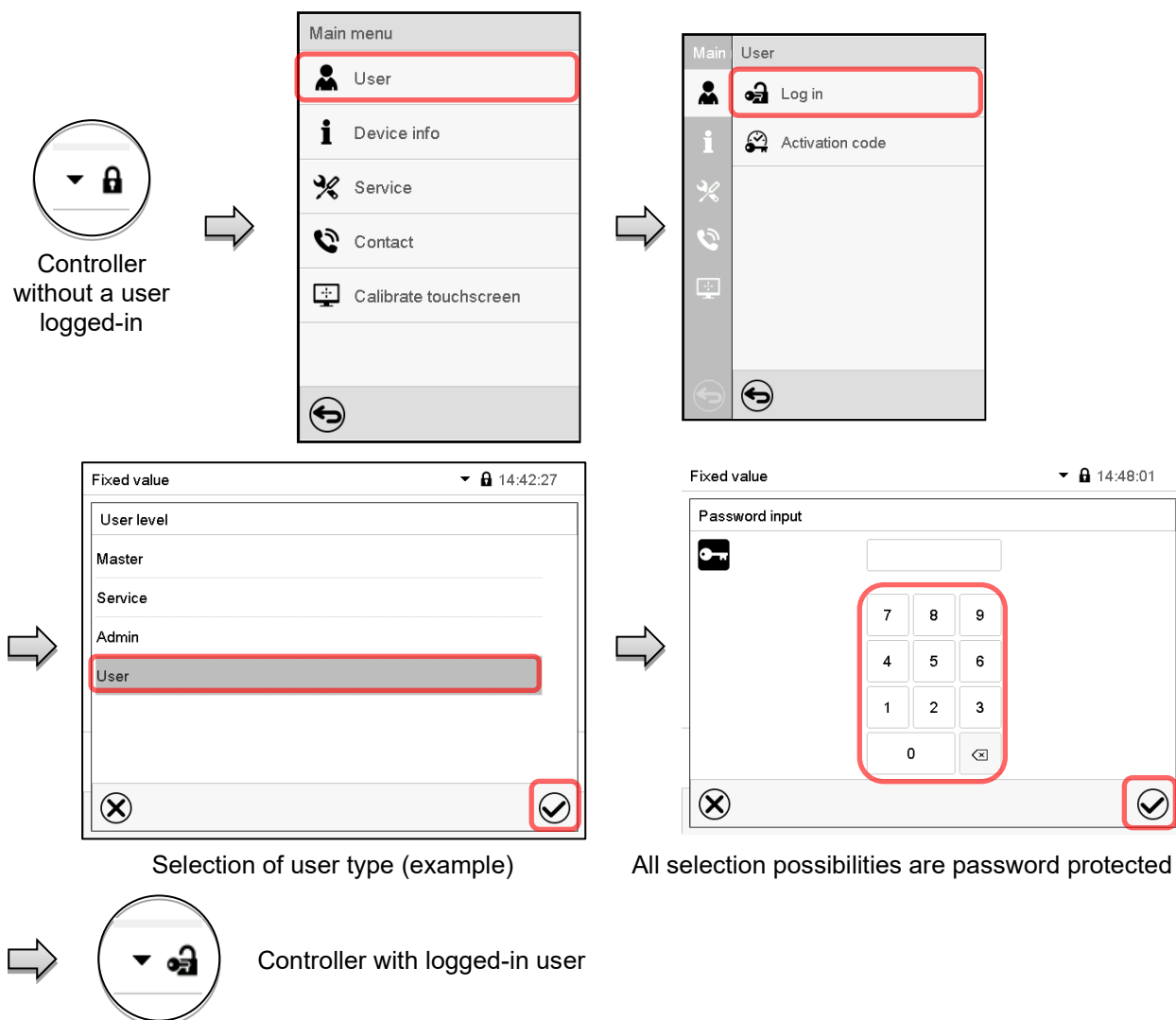

After completing the settings, press the **Confirm** icon to take over the entries and exit the menu, **or** press the **Close** icon to exit the menu without taking over the entries.

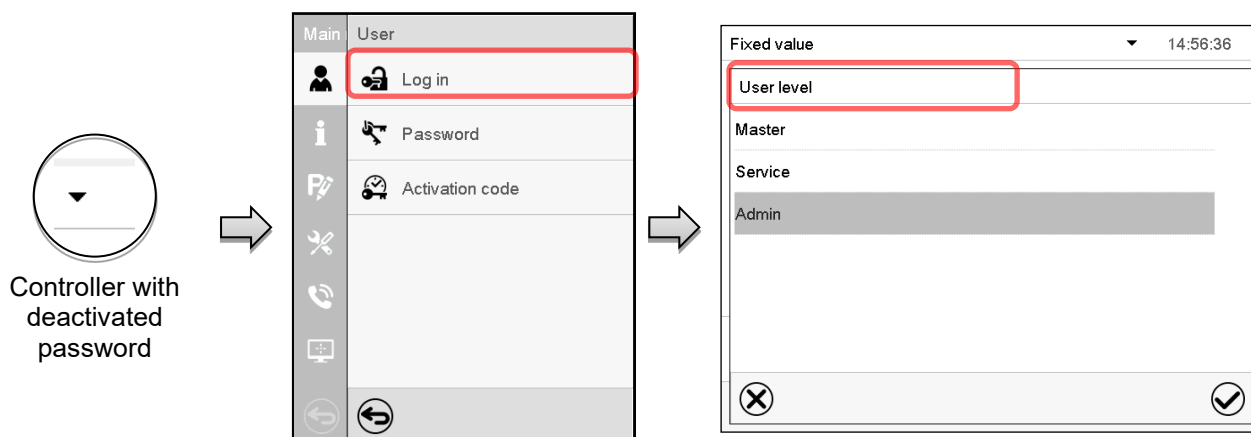

### 13.3 Log out

Path: [Main menu](#) > [User](#) > [Log out](#)

User logoff with “Admin” authorization

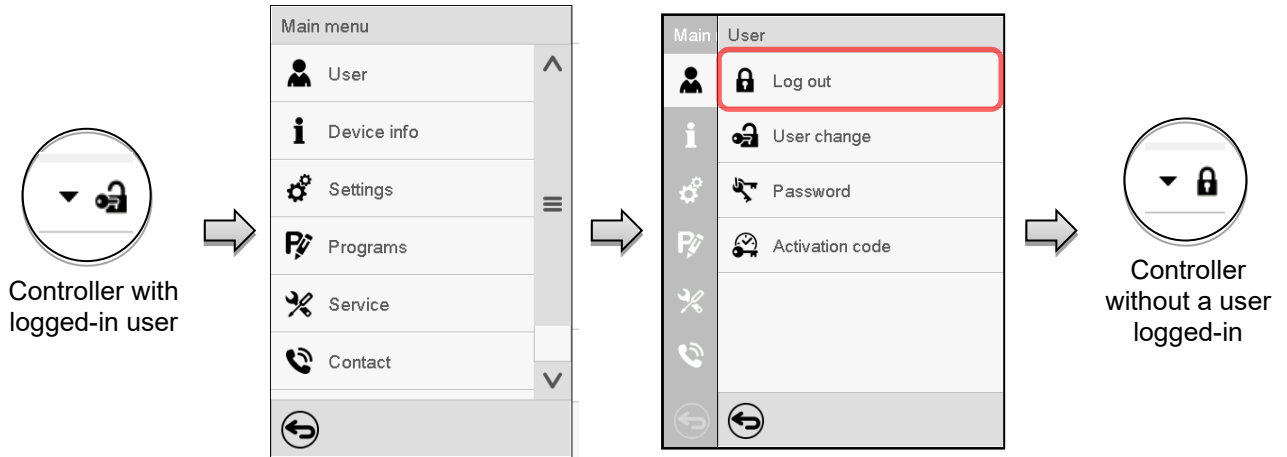

User logoff with “Admin” authorization

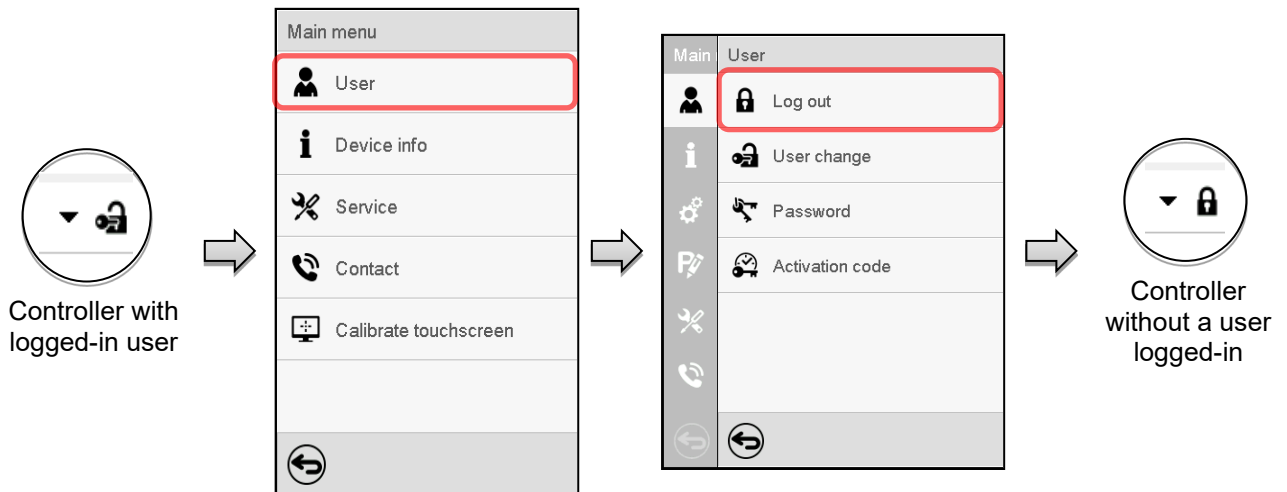

### 13.4 User change

If the password function has been deactivated (chap.13.5.2) this function is not available.

Path: [Main menu](#) > [User](#) > [User change](#)

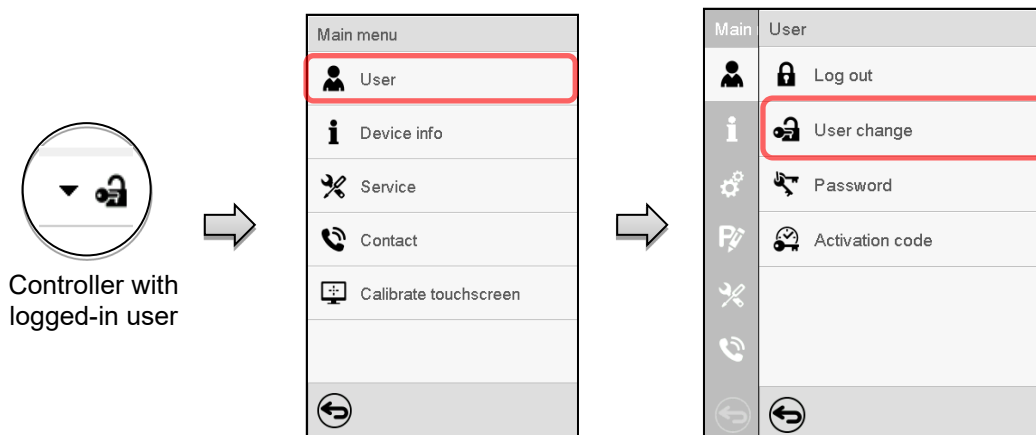

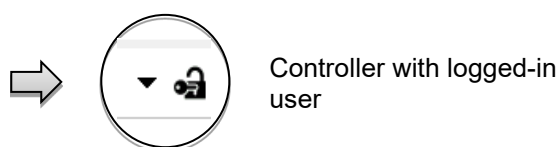
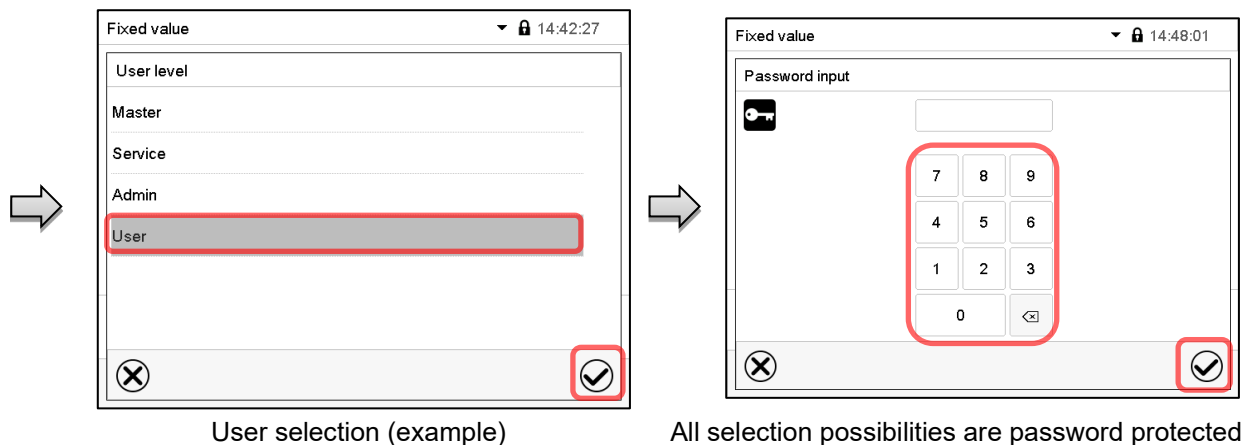

## 13.5 Password assignment and password change

This function is not available for a user logged-in with “User” authorization.

### 13.5.1 Password change

A logged-in user can change the passwords of his current level and of the next lower level(s).

**Example:** A user with “Admin” authorization can change the passwords for the “Admin” and “User” authorization levels.

Path: [Main menu](#) > [User](#) > [Password](#)

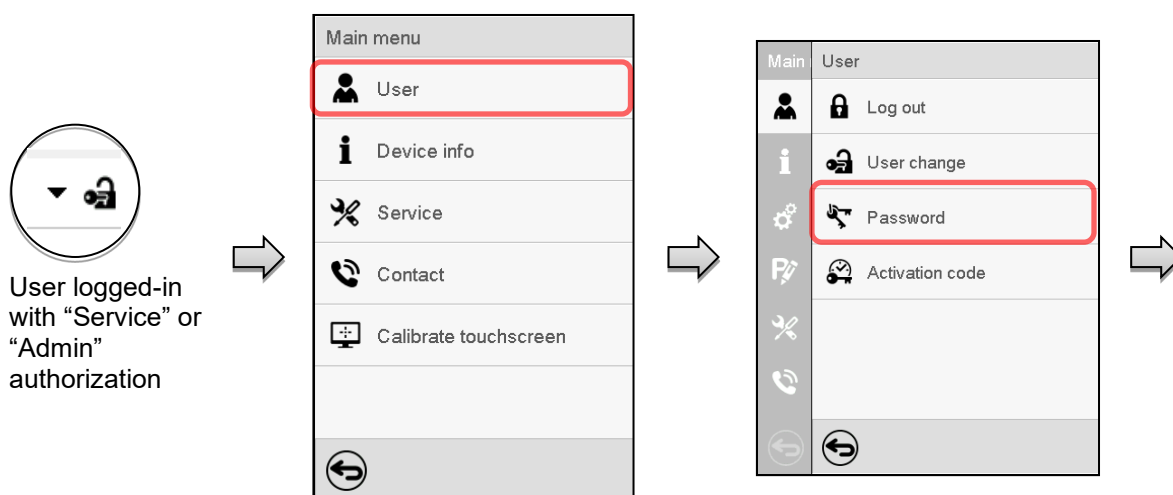

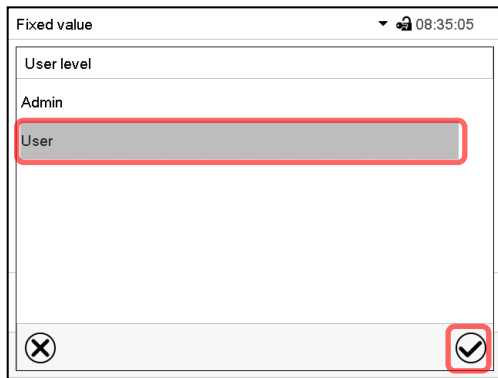

Selection of the authorization level (example: view with "Admin" authorization)

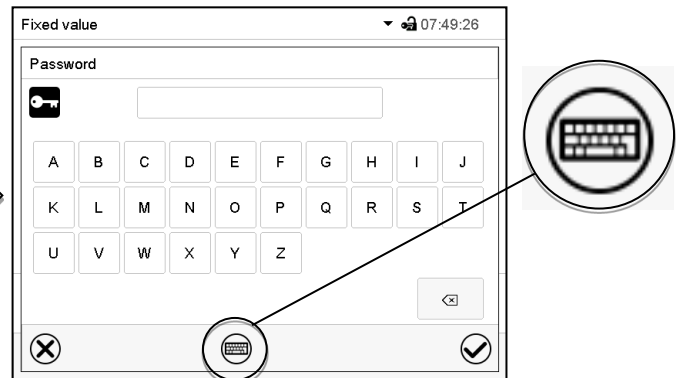

Enter desired password. If desired, press the **Change keyboard** icon to access other entry windows.

In the "Keyboard switch" window you can select different keyboards to enter uppercase and lowercase letters, digits, and special characters. All types of characters can be combined within one single password.

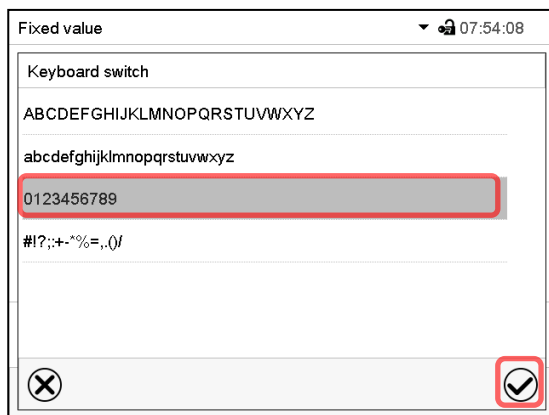

Example: access the digit entry window

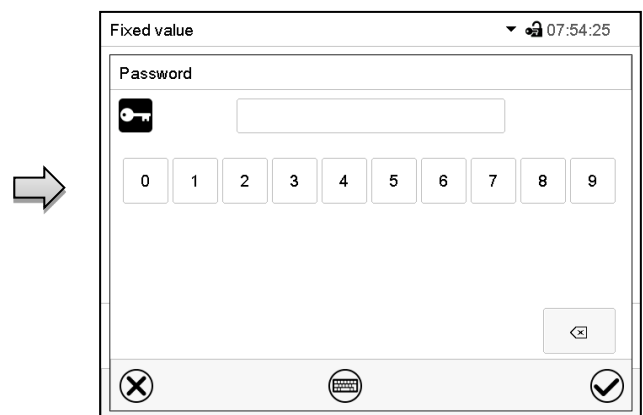

Entry of digits

To confirm the entry, press the **Confirm** icon.

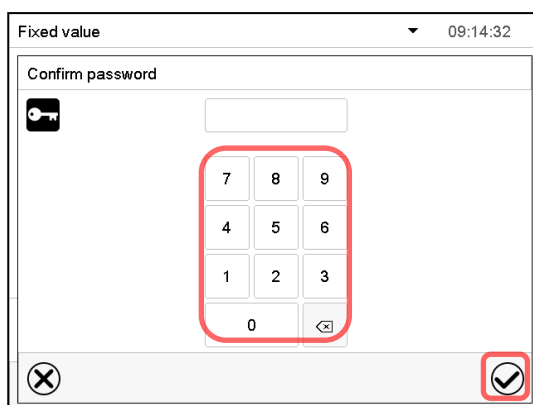

Repeat the password entry for confirmation (sample picture). For each character of the password, the required keyboard appears automatically.

Then press the **Confirm** icon.

### 13.5.2 Deleting the password for an individual authorization level

A user logged-in with “Service” or “Admin” authorization can delete the passwords of his current level and of the next lower level(s). To do this no password is entered during a password change.

Path: **Main menu > User > Password**



Controller with logged-in user (e.g. with “Admin” authorization)

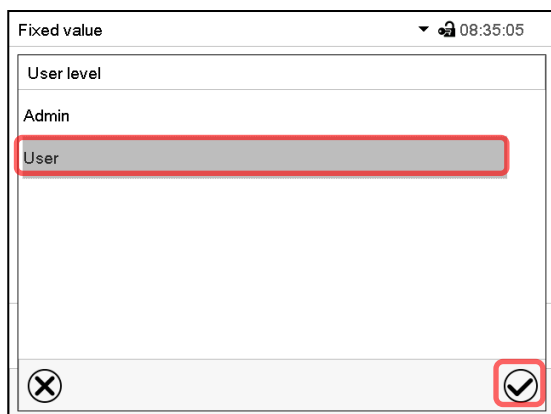
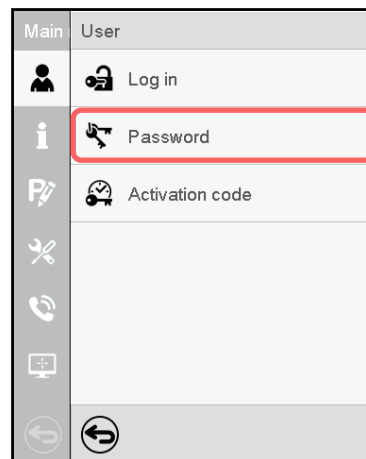
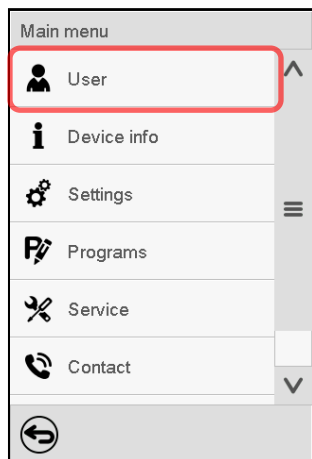

Select the authorization level for which the password shall be deleted.

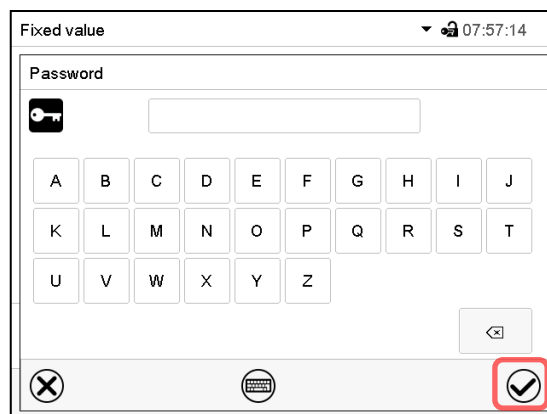

Do NOT enter anything in the “Password” screen. Press the **Confirm** icon.

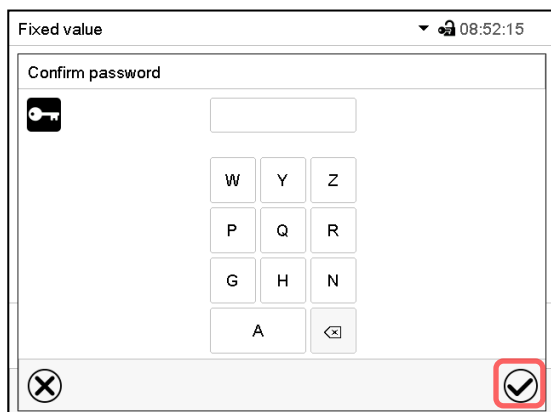

Do NOT enter anything in the “Confirm password” screen. Press the **Confirm** icon.

The password is deleted.

### 13.5.3 New password assignment for “service” or “admin” authorization level when the password function was deactivated

If the password protection for an authorization level has been deactivated, i.e., no password is assigned, no login for this level is possible. Therefore access to this authorization level is available without login.

If the password for the “Service” or “Admin” authorization has been deleted (chap. 13.5.2), a new password can be assigned for the current level and the next lower level(s) without user login.

**Example:** The password for the “Admin” authorization level was deleted, therefore every user without login has full access to the functions of the “Admin” authorization level. If access to this level shall become password protected again, the user can assign a new password for the “Admin” authorization level with the “Password” function.

Path: [Main menu](#) > [User](#) > [Password](#)

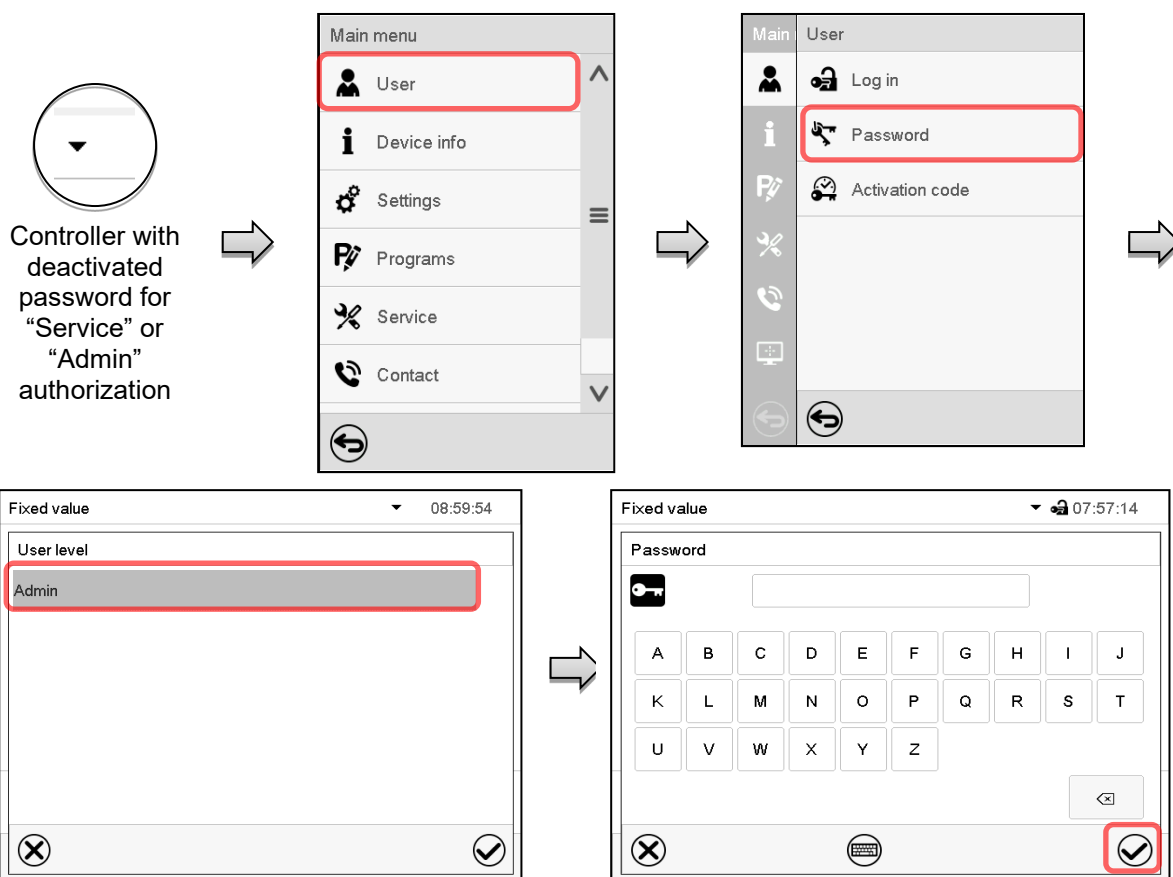

Select the authorization level, for which you want to assign a password.  
(Example: “Admin” authorization)

Enter the desired password. If desired, press the **Change keyboard** icon to access other entry windows.

To confirm the entry, press the **Confirm** icon.

Repeat the password entry for confirmation. For each character of the password, the required keyboard appears automatically. Then press the **Confirm** icon.

### 13.6 Activation code

Certain functions of the controller can be unlocked with a previously generated activation code.

The activation code enables access to functions available only in the “Service” authorization level by users without a “Service” authorization. Such functions include e.g., adjustment or extended configurations.

The activation code is available in authorization levels.

Path: **Main menu > User > Activation code**

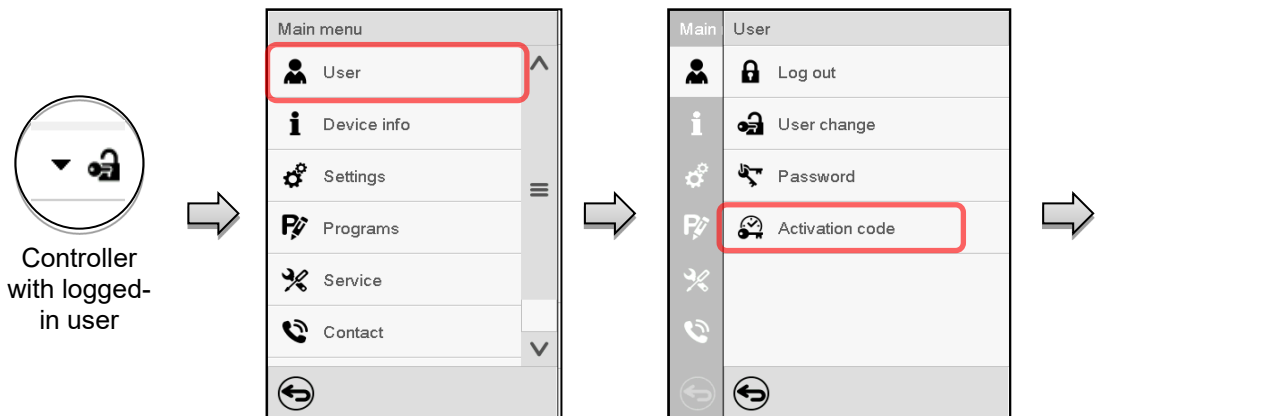

This screenshot shows the 'Activation code' menu. At the top, there is a field for the activation code with four empty entry fields, the first of which is highlighted with a red box. Below this, there is an 'Expiration date' field showing '01.01.1984 | 00:00:00'. To the right, there is a 'Rights' section with several checkboxes: 'Adjustment', 'Configuration', 'Parameterization', 'Service', and 'Parameter sets'. The 'Configuration' checkbox is checked. At the bottom, there is a 'User' field and a back arrow icon.

Activation code menu.  
Select the first of the four entry fields.

This screenshot shows the 'Activation code' entry window. It features a numeric keypad (0-9) and an alphanumeric keypad (A-F). The first four characters of the activation code have been entered. A 'Confirm' icon (a checkmark in a circle) is visible at the bottom right of the keypad area. There is also a back arrow icon at the bottom left.

Activation code entry window.  
Enter the first four characters of the activation code and press the **Confirm** icon.

Select the next of the four entry fields and proceed accordingly until the entire code has been entered.

This screenshot shows the 'Activation code' menu with the code 'AAAA-AAAA-AAAA-AAAA' entered into the four entry fields. The 'OK' button is highlighted with a red box. The 'Expiration date' is '01.01.1984 | 00:00:00'. The 'Rights' section shows 'Configuration' checked. The 'User' field is empty. A back arrow icon is at the bottom left.

“Activation code” menu with entered code (sample view).  
Press **OK** to take over the entry.

The available functions are indicated by marked checkboxes.

Example: Extended configurations available.

This is a close-up of the 'Rights' section from the previous screenshot. It shows a list of checkboxes: 'Adjustment', 'Configuration' (checked), 'Parameterization', 'Service', and 'Parameter sets'.

Under “Expiration date” the date of expiry of the code is displayed.



## 14. General controller settings

Most of the general settings can be accessed in the “Settings” submenu, which is available for users with “Service” or “Admin” authorization level. It serves to enter date and time, select the language for the controller menus and the desired temperature unit and to configure the controller’s communication functions.

### 14.1 Selecting the controller’s menu language

The MB2 program controller communicates by a menu guide using real words in German, English, French, Spanish, and Italian.

Path: [Main menu](#) > [Settings](#) > [Chamber](#)

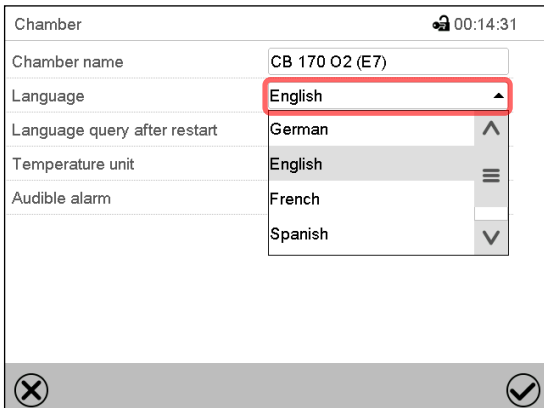

The screenshot shows the 'Chamber' submenu with a lock icon and the time 00:14:31. The 'Language' dropdown menu is open, showing options: German, English (highlighted with a red box), French, and Spanish. Other settings include Chamber name: CB 170 O2 (E7), Language query after restart: German, Temperature unit: English, and Audible alarm: French.

“Chamber” submenu.

Select the desired language.

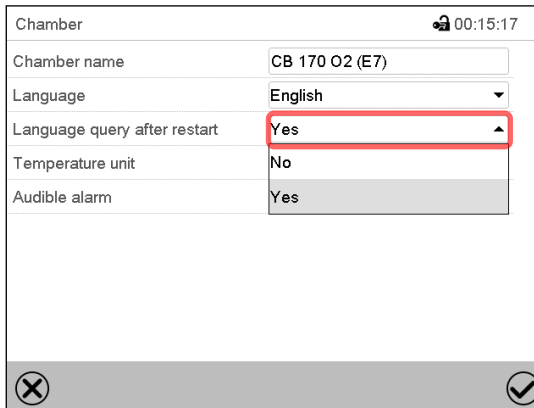

The screenshot shows the 'Chamber' submenu with a lock icon and the time 00:15:17. The 'Language query after restart' dropdown menu is open, showing options: Yes (highlighted with a red box) and No. Other settings include Chamber name: CB 170 O2 (E7), Language: English, Temperature unit: No, and Audible alarm: Yes.

“Chamber” submenu.

Select if there shall be a language query after restarting the chamber and press the **Confirm** icon.

Return to Normal display with the **Back** icon to take over the entries.

### 14.2 Setting date and time

Following start-up of the chamber after language selection:

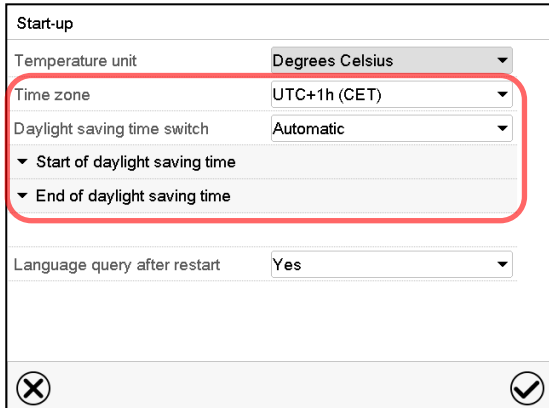

The screenshot shows the 'Start-up' submenu with a lock icon. The 'Time zone' dropdown menu is open, showing options: UTC+1h (CET) (highlighted with a red box) and Automatic. Other settings include Temperature unit: Degrees Celsius, Start of daylight saving time, End of daylight saving time, and Language query after restart: Yes.

Select the time zone and configure the daylight saving time switch.

Or later:

Path: **Main menu > Settings > Date and time**

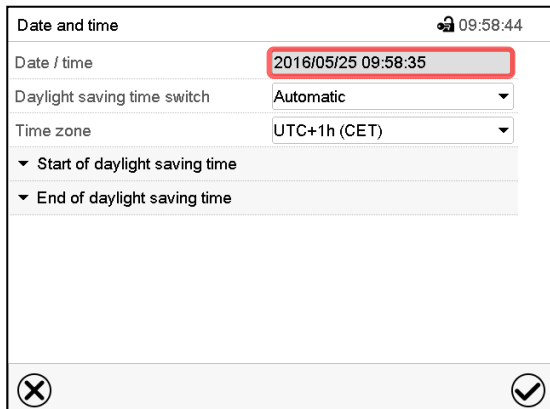

“Date and time” submenu.  
Select the field “Date / time”.

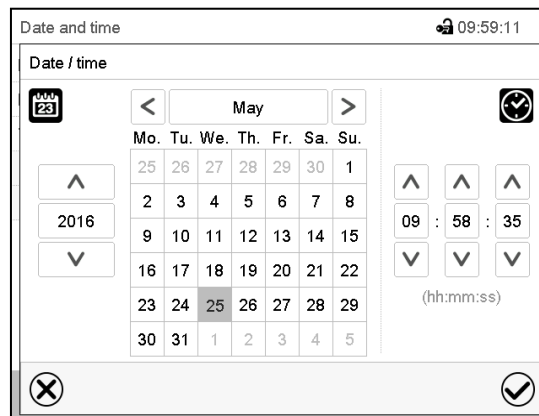

“Date / time” entry menu.  
Enter date and time and press the **Confirm** icon.

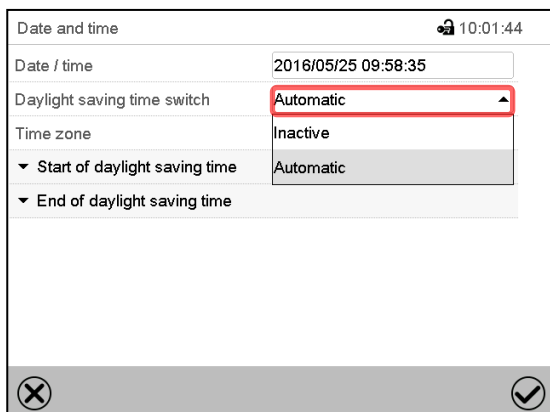

“Date and time” submenu.  
In the field “Daylight saving time switch” select the desired setting “Automatic” or “Inactive”.

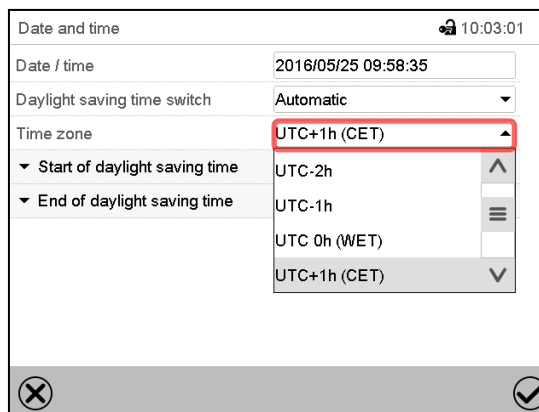

“Date and time” submenu.  
Select the desired time zone and press the **Confirm** icon.

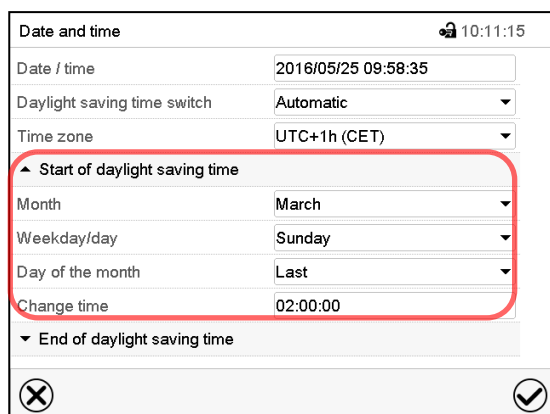

“Date and time” submenu.  
Select the desired start of the daylight saving time.

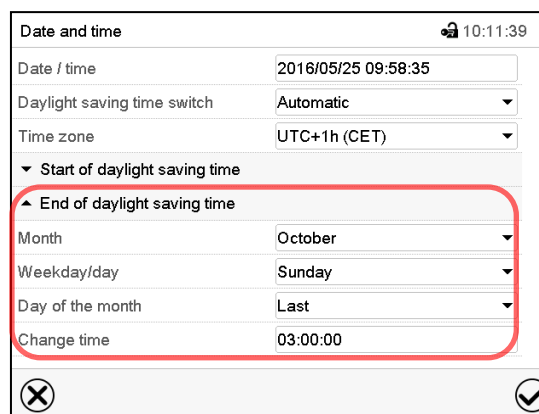

“Date and time” submenu.  
Select the desired end of the daylight saving time and press the **Confirm** icon.

After completing the settings, press the **Confirm** icon to take over the entries and exit the menu, **or** press the **Close** icon to exit the menu without taking over the entries.

## 14.3 Selecting the temperature unit

Following start-up of the chamber:

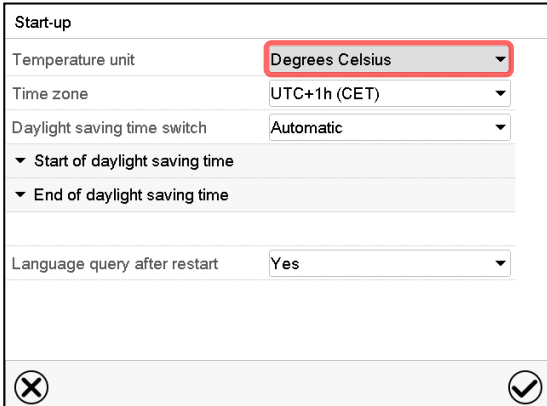

Start-up

Temperature unit: Degrees Celsius

Time zone: UTC+1h (CET)

Daylight saving time switch: Automatic

Start of daylight saving time

End of daylight saving time

Language query after restart: Yes

Or later:

Path: [Main menu](#) > [Settings](#) > [Chamber](#)

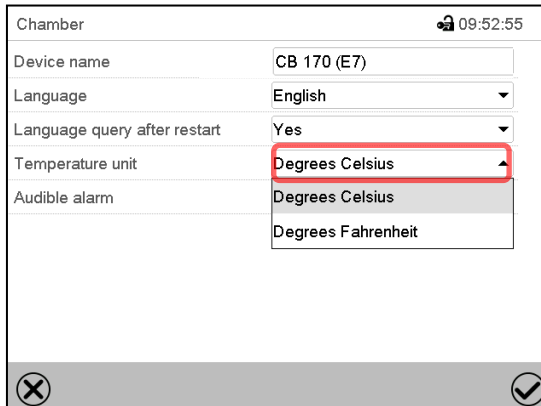

Chamber 09:52:55

Device name: CB 170 (E7)

Language: English

Language query after restart: Yes

Temperature unit: Degrees Celsius

Audible alarm: Degrees Celsius

Degrees Fahrenheit

Select the desired temperature unit and press the **Confirm** icon.

Change of the temperature unit between °C and °F.

If the unit is changed, all values are converted accordingly

	C = degree Celsius	0 °C = 31°F	Conversion: [value in °F] = [value in °C] * 1,8 + 32
	F= degree Fahrenheit	100 °C = 212°F	

## 14.4 Display configuration

### 14.4.1 Adapting the display parameters

This function serves to configure parameters like display brightness and operating times.

Path: [Main menu](#) > [Settings](#) > [Display](#) > [Display](#)

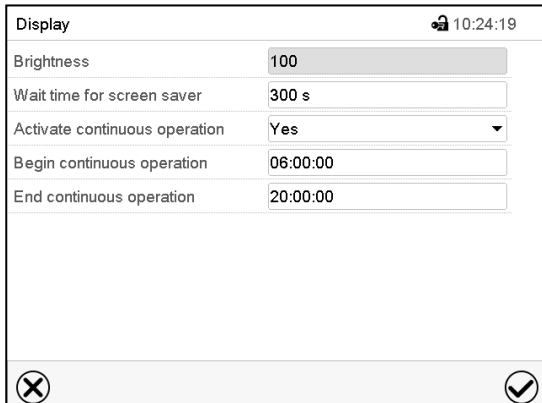

Display 10:24:19

Brightness: 100

Wait time for screen saver: 300 s

Activate continuous operation: Yes

Begin continuous operation: 06:00:00

End continuous operation: 20:00:00

“Display” submenu.

- Select the field “Brightness”.
- Move the grey slide to the left or right to define the brightness of the display
- left = darker (minimum value: 0)
  - right = brighter (maximum value: 100)
- Press the **Confirm** icon.

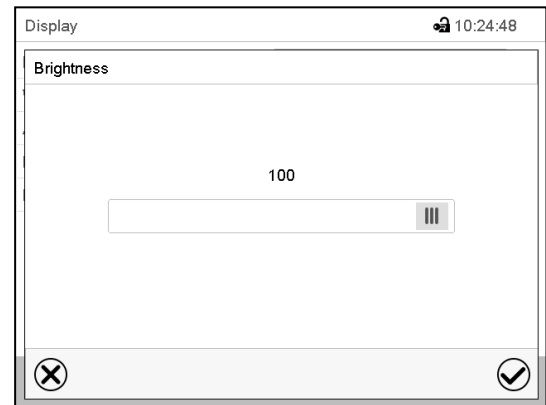

- Select the field “Wait time for screen saver” and enter the desired waiting time for the screen saver in seconds. Setting range: 10 sec up to 32767 sec. During the waiting time the display is off. Confirm entry with Confirm icon.
  - In the field “Activate continuous operation” select the desired setting “Yes” or “No”.
- 
- Select the field “Begin continuous operation” (possible only if continuous operation is activated) and enter the time with the arrow keys. Confirm entry with Confirm icon.
  - Select the field “End continuous operation. (only possible if continuous operation is activated) and enter the time with the arrow keys. Confirm entry with **Confirm** icon.

After completing the settings, press the **Confirm** icon to take over the entries and exit the menu, **or** press the **Close** icon to exit the menu without taking over the entries.

## 14.4.2 Touchscreen calibration

This function serves to optimize the display for the user’s individual angular perspective.

Path: [Main menu](#) > [Calibrate touchscreen](#)

Fixed value		22:37:16	
		Setpoint	Actual value
Temperature	°C	37.0	37.0
CO2	%	5.0	5.0
O2	%	21.0	21.0
Humidity	%RH	93.0	93.0

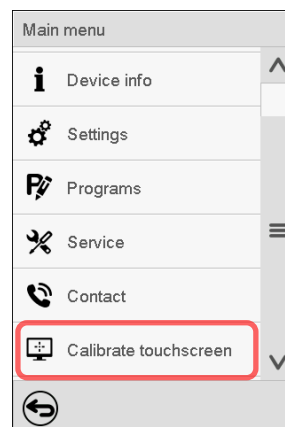

Normal display.

Select “Calibrate touchscreen” and follow the instructions on the display.

You need to touch all four corners of the touchscreen to calibrate it. Appropriate boxes appear successively in each corner.

	<p>The waiting icon shows how much time there is left to touch the currently activated box. If the box is not touched within this period, calibration is aborted and the display changes to Normal display.</p>
--	---

After completing the calibration, i.e., touching all four boxes, the display changes to Normal display.

## 14.5 Network and communication

For these settings at least the “Admin” authorization level is required.

### 14.5.1 Serial RS485 interface (available via BINDER INDIVIDUAL Customized Solutions)

This menu allows to configure the communication parameters of the RS485 interface.

The device address is required to recognize chambers with this interface type in a network, e.g. when connecting it to the optional BINDER APT-COM™ 4 Multi Management Software (chap. 18.1). In this case do not change the other parameters.

Path: [Main menu](#) > [Settings](#) > [Serial interfaces](#)

Serial interfaces	
Baud rate	9600
Data format	8 - N - 1
Minimum response time	40 ms
Device address	1

“Serial interfaces” submenu.

- Select the desired setting in the field “Baud rate”.

Baud rate	9600
Data format	9600
Minimum response time	19200
Device address	38400

- Select the desired setting in the field “Data format”.

Data format	8 - N - 1
Minimum response time	8 - N - 1
Device address	8 - O - 1
	8 - E - 1

- Select the field “Minimum response time” and enter the desired minimum response time. Confirm entry with Confirm icon.
- Select the field “Device address” and enter the device address. Factory setting is “1”. Confirm entry with **Confirm** icon.

After completing the settings, press the **Confirm** icon to take over the entries and exit the menu, **or** press the **Close** icon to exit the menu without taking over the entries.

## 14.5.2 Ethernet

### 14.5.2.1 Configuration

Path: [Main menu](#) > [Settings](#) > [Ethernet](#)

Ethernet <span style="float: right;">🔒 10:56:59</span>	
IP address assignment	Automatic (DHCP)
IP address	
Subnet mask	
Standard gateway	
DNS device name	MAC000CD809E33F-TYP7035€
DNS server address	Automatic
DNS server	
<span>⊗</span> <span style="float: right;">✔</span>	

“Ethernet” submenu.

- In the field “IP address assignment” select the desired setting “Automatic (DHCP)” or “Manual”.

With selection “Manual” you can enter the IP-address, the subnet mask and the standard gateway manually.

IP address assignment	Automatic (DHCP)
IP address	Manual
Subnet mask	Automatic (DHCP)

IP address assignment	Manual
IP address	223.223.223.1
Subnet mask	255.255.255.0
Standard gateway	0.0.0.0

- Select “DNS device name” and enter the DNS device name. Confirm entry with Confirm icon.
- In the field “DNS server address” select the desired setting “Automatic” or “Manual”.

With selection „Manual“ you can enter the DNS server address manually.

Standard gateway	Manual
DNS device name	Automatic
DNS server address	Automatic

DNS server address	Manual
DNS server	0.0.0.0

After completing the settings, press the **Confirm** icon to take over the entries and exit the menu, **or** press the **Close** icon to exit the menu without taking over the entries.

### 14.5.2.2 Display of MAC address

Path: [Main menu](#) > [Device info](#) > [Ethernet](#)

Ethernet		🔒 13:49:56
Ethernet	Yes	<span>⬆</span> <span>☰</span> <span>⬇</span>
MAC address	00-0C-D8-09-E3-3F	
IP address	192.168.14.87	
Subnet mask	255.255.255.0	
Standard gateway	192.168.14.1	
DNS server	192.168.10.5	
DNS device name	MAC00CD809E33F-TYP703596	

“Ethernet” submenu (example).

### 14.5.3 E-Mail

As soon as an alarm was triggered, an e-mail is sent to the configured e-mail address.

Path: [Main menu](#) > [Settings](#) > [Email](#)

E-mail address entry:

email		🔒 11:28:45
Email address	<input type="text"/>	<span>⬆</span> <span>☰</span> <span>⬇</span>
Email address	<input type="text"/>	
Email address	<input type="text"/>	
▼ Email server		

“Email” submenu.

Select the desired e-mail address field and enter the e-mail address. You can use the **Keyboard change** icon for entry. Confirm entry with **Confirm** icon.

E-mail server settings:

email		🔒 03:40:17
Email address 1	<input type="text"/>	<span>⬆</span> <span>☰</span> <span>⬇</span>
Email address 2	<input type="text"/>	
Email address 3	<input type="text"/>	
▲ Email server		
Authentication	None	
Email user name	Username	
Email password	Password	
SMTP mail server URL	smtp.example.net	
SMTP port number	25	
Email sender	chamber@example.net	

“Email” submenu.

Select the field “Email server” to access the settings

- In the field “Authentication” select the desired setting “None” or “SMTP” auth“.

With the setting “SMTP auth”, you can enter a password under “Email password”.

Authentication	None
Email user name	None
Email password	SMTP auth
SMTP mail server URL	192.168.10.45

- Select the field “Email user name” and enter the desired user name. Confirm entry with Confirm icon.
- Select the field “SMTP mail server URL” and enter the SMPT mail server URL. Confirm entry with **Confirm** icon.
- Select the field “SMTP port number” and enter the desired port number. Standard setting: “25”. Confirm entry with **Confirm** icon.
- Select the field “Email sender” and enter the desired Email sender. Confirm entry with **Confirm** icon.

After completing the settings, press the **Confirm** icon to take over the entries and exit the menu, **or** press the **Close** icon to exit the menu without taking over the entries.

## 14.6 USB menu: Data transfer via USB interface

The USB port is located in the instrument box.



CB/CB-UL: Before you begin a controller firmware update, note the humidity control value (chap. 14.6.1).

When you insert a USB-stick, the “USB” menu opens.



The USB stick must be formatted with FAT32 and have at least 8GB of memory.

Depending on the user’s authorization level, different functions (highlighted in black) are available for the logged-in user.

USB menu	
Log-out USB stick	▲
Export new chart recorder data (*.DAT)	
Export all chart recorder data (*.DAT)	
Export all chart recorder data (*.csv)	☰
Import configuration and programs	
Export configuration and programs	
Import programs	
Export service data	
Software update	▼
✔	

Available functions  
with “User” authorization level

USB menu	
Log-out USB stick	▲
Export new chart recorder data (*.DAT)	
Export all chart recorder data (*.DAT)	
Export all chart recorder data (*.csv)	☰
Import configuration and programs	
Export configuration and programs	☰
Import programs	
Export service data	
Software update	▼
✔	

Available functions  
with “Admin” authorization level



Function	Explanation
Log-out USB stick	Log-out USB stick bevor pulling it
Export new chart recorder data (*.DAT)	Export chart recorder data, which have been added since last export, in .dat format
Export all chart recorder data (*.DAT)	Export all chart recorder data in .dat format
Export all chart recorder data (*.csv)	Export all chart recorder data in .csv format
Import configuration and programs	Import configuration and timer / time / week programs
Export configuration and programs	Export configuration and timer / time / week programs
Import programs	Import timer / time / week programs
Export service data	Export service data
Software update	Controller firmware update

### 14.6.1 Controller firmware update

Required authorization: Admin or Service.

Before inserting the USB stick:

Enter the "Various" submenu. Path: [Main menu](#) > [Settings](#) > [Various](#)

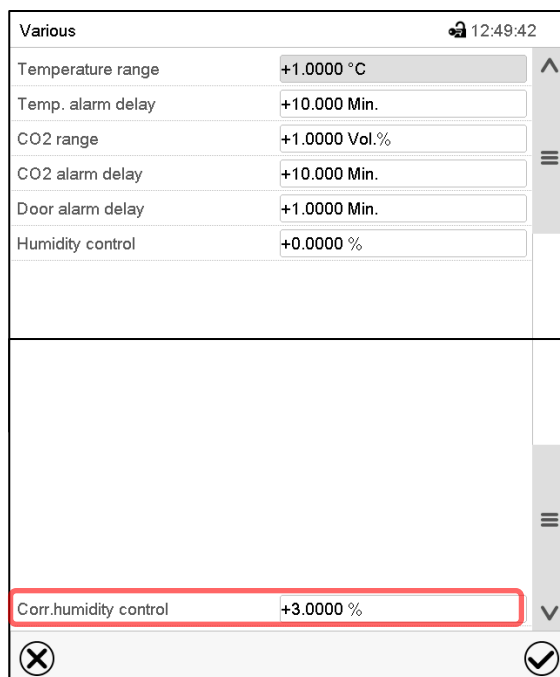

Submenu "Various".

Scroll all the way down and select the function "Corr.humidity control" (sample view).

Note down the displayed value.

Insert the USB stick and select "Software update". The new firmware will be installed.

Go to the "Various" menu again. Scroll all the way down and select the function "Corr.humidity control". Enter the previously noted value and confirm your entry with the **Confirm** icon.

## 15. General information

### 15.1 Service contact page

Path: [Main menu](#) > [Contact](#)

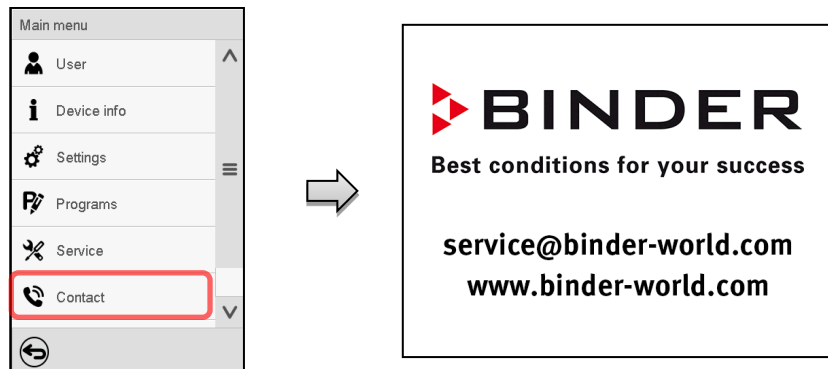

### 15.2 Current operating parameters

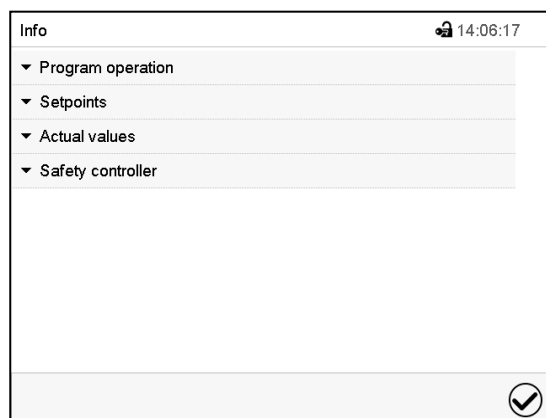
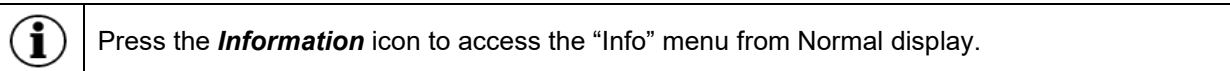





"Info" menu.  
Select the desired information.

- Select "Program operation" to see information on a currently running program.
- Select "Setpoints" to see information on the entered setpoints and operation lines.
- Select "Actual values" to see information on the current actual values.
- Select "Safety controller" to see information on the safety controller status.

### 15.3 Event list

The “Event list” displays status information and errors of the current day. It enables to view the last 100 events or defective conditions of the chamber.

	Press the <b>Event list</b> icon to access the event list from Normal display.
---	--

Event list			13:18:52
2016/06/07	09:09:53	Login Service (Touch)	^
2016/06/07	09:09:53	Automatic log out Admin	
2016/06/07	07:47:25	Login Admin (Touch)	
2016/06/07	07:46:15	Automatic log out Admin	
	2016/06/07	07:46:15	Power on
	2016/06/06	16:08:09	Power off
	2016/06/06	10:50:25	Login Admin (Touch)
	2016/06/06	10:49:44	Automatic log out Admin
	2016/06/06	10:49:44	Power on
			v













Event list

	Press the <b>Update</b> icon to update the event list.
--	--

	<b>Attention:</b> Following a modification of the language setting (chap. 14.1) or the storage interval of the chart recorder (chap. 16.2) the Event list is cleared.
---	---

### 15.4 Technical chamber information

Path: [Main menu > Device info](#)

Main	Device info		
	 General	Chamber name and setup	
	<b>v1.x</b> Versions	Versions of CPU, I/O module and safety controller	for BINDER Service
	 In-/Outputs	Information on digital and analog inputs and outputs and phase angle outputs	for BINDER Service
	 Modbus inputs	Information on modbus analog and digital inputs	for BINDER Service
	 Ethernet	Information on Ethernet connection, MAC address display	chap. 14.5.2
			
		Back to main menu	

## 16. Chart recorder display

This view offers graphic representation of the measurement course. Data representation imitates a chart recorder and allows recalling any set of measured data at any point of time taken from the recorded period.

### 16.1 Views

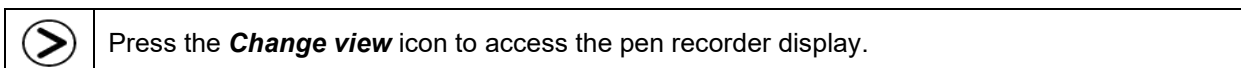

#### 16.1.1 Show and hide legend

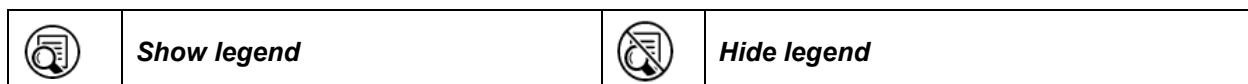

Press the **Show legend** icon to display the legend on the right side of the display

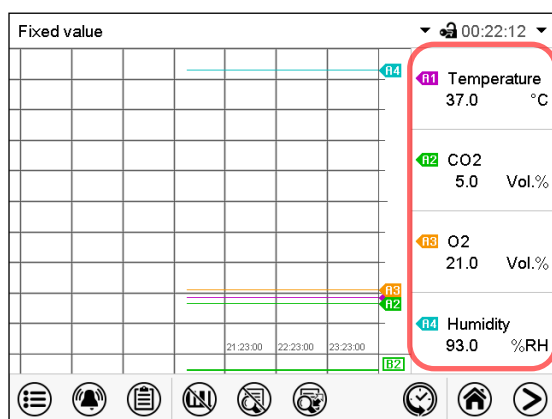

Legend shown on the right side of the display

#### 16.1.2 Switch between legend pages

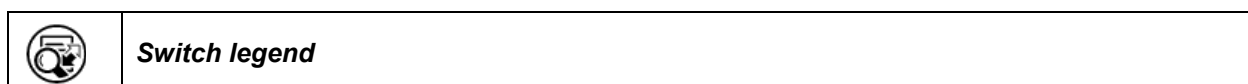

Press the **Switch legend** icon to switch between the legend pages

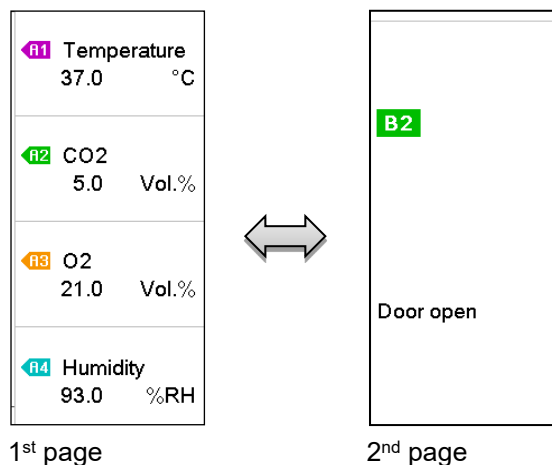

Switching between the legend pages

### 16.1.3 Show and hide specific indications

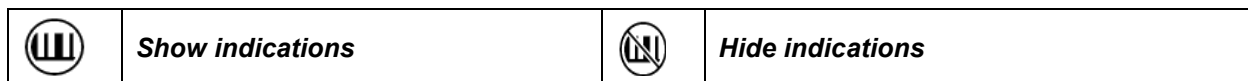

Press the **Show indications** icon to display the indication "Door open" (B2).

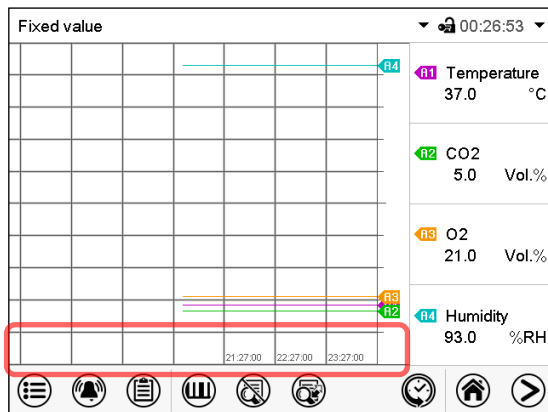

Indication "Door open" displayed (example: 1<sup>st</sup> page).

### 16.1.4 History display

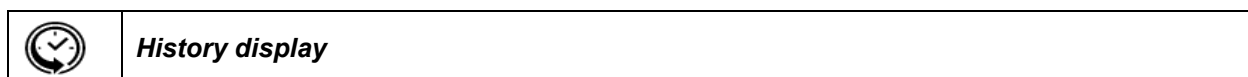

Press the **History display** icon to change to the history display.

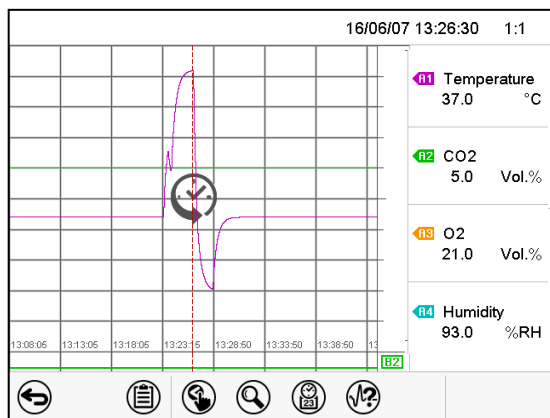

History display.

The chart recorder is paused. Data recording continues in the background.

Move the central red line by tapping and holding to the desired position.

The legend at the right side shows the values of the current line position.

Then further icons appear:

### History display: Curve selection



Press the **Curve selection** icon to access the “Curve selection” submenu.

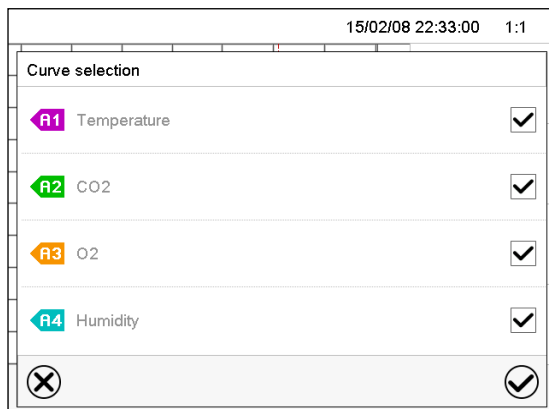

“Curve selection” submenu.

Select the curves to be displayed by checking the checkbox of the corresponding parameter. Press the **Confirm** icon

### History display: Search the required instant

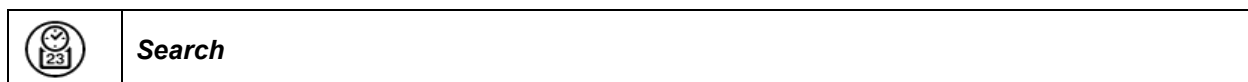

Press the **Search** icon to access the “Search” submenu.

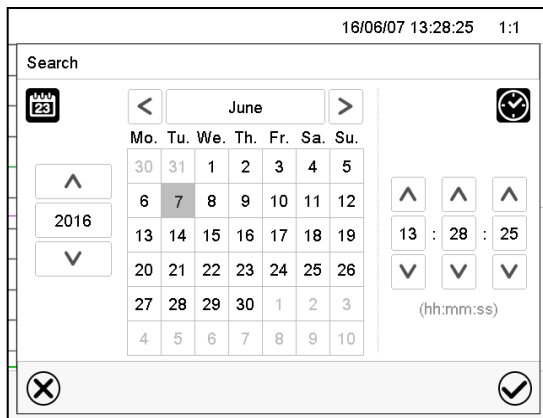

“Search” submenu.

Select the required instant by entering its date and time and press the **Confirm** icon

### History display: Zoom function



Press the **Zoom** icon to access the “Zoom” submenu.

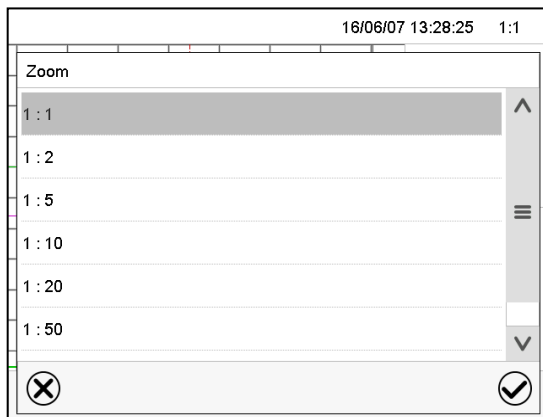

“Zoom” submenu.

Select the zoom factor and press the **Confirm** icon

### History display: Show and hide scroll buttons to scroll to an instant



Press the **Show scroll buttons** icon to access the “Page selection” submenu.

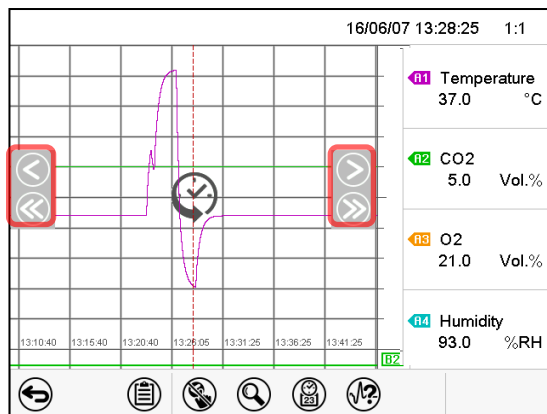

“Page selection” submenu.

Scroll buttons are shown on the left and on the right. Use them to move along the timeline.

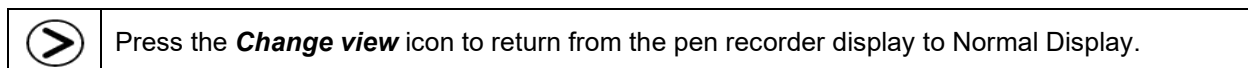

## 16.2 Setting the parameters

This menu allows setting the storage interval, the type of values to be shown and the scaling of the charts.

Path: [Main menu](#) > [Settings](#) > [Measurement chart](#)

Measurement chart		00:31:49
Storage interval	60 s	▲
Storage values	Mean values	▼
Min. temperature °C	+0.0000 °C	
Max. temperature °C	+200.00 °C	
CO2 Min. Vol.%	+0.0000 Vol.%	☰
CO2 Max. Vol.%	+30.000 Vol.%	
O2 Min. Vol.%	+0.0000 Vol.%	
O2 Max. Vol.%	+100.00 Vol.%	
Min. humidity %RH	+0.0000 %RH	
Max. humidity %RH	+100.00 %RH	▼
<input type="checkbox"/> <input type="checkbox"/>		

“Measurement chart” submenu.

- Select the field “Storage interval” and enter the desired storage interval. Confirm entry with Confirm icon.  
The available presentation depends on the pre-selected storage rate. Factory setting: 60 seconds. This means the higher the storage rate, the more precisely but shorter the data representation will be.

- In the field “Storage values” select the desired value type to be displayed.

Measurement chart		00:33:48
Storage values	Mean values	▲
Min. temperature °C	Mean values	
Max. temperature °C	Current values	
CO2 Min. Vol.%	Min. value	
CO2 Max. Vol.%	Max. value	

- For scaling the representation select the desired minimum and maximum temperature, CO<sub>2</sub> / O<sub>2</sub> or humidity value and enter the desired values. Confirm each entry with Confirm icon.

### Display ranges:

- Temperature: 0 °C up to 200 °C
- CO<sub>2</sub>: 0 Vol.-% up to 100% Vol.-%.
- O<sub>2</sub>: 0 Vol.-% up to 100% Vol.-%.
- Humidity: 0% r.h. up to 100% r.h.

Setting the storage rate or rescaling (minimum and/or maximum) will clear the measured-value memory and the event list.

NOTICE	
	<p><b>Danger of information loss when setting the storage rate or rescaling.</b></p> <p><b>Data loss of measured-value memory and event list.</b></p> <p>➤ Change the storage rate or scaling ONLY if the previously registered data is no longer needed.</p>

After completing the settings, press the **Confirm** icon to take over the entries and exit the menu, **or** press the **Close** icon to exit the menu without taking over the entries.



## 17. CBF / CBF-UL: Humidification system

The chamber is equipped with a capacitive humidity sensor. This results in a control accuracy of up to +/- 3 % r.h. of the set point.

You can turn humidity control on or off in the controller (chap. 6.7).

With humidity control turned off, the humidification module cools down. After activation it will take up to 10 minutes until the humidification function is fully available again.



Heat emission of electrical devices connected inside the chamber may modify the temperature and humidity range.

The chambers are equipped with a door heating system to avoid condensation in the door area.

### 17.1 Function of the humidifying system

The humidifying system is located in the humidity generation module. In a cylindrical container with a volume of approx. 0,07 liters an electrical resistance heating evaporates water. The water content is kept close to the boiling point, and thus steam can be immediately generated in sufficient quantity for rapid humidity increases or for compensation of humidity losses, e.g. by door openings.

Freshwater is supplied by manually filling a freshwater bag. A peristaltic pump transports the water to the humidification module via a silicone tube.



**In order to ensure accurate humidifying, observe the following points with regard to the freshwater supply:**

- Water type: deionized (demineralized) water
- To ensure humidification during 24 hours even at high humidity set-points, we recommend filling the freshwater bag at the end of each day.
- Water intake temperature NOT below +5 °C / 41 °F and not exceeding 40 °C / 104 °F.



BINDER GmbH is NOT responsible for the water quality provided by the customer. Any problems and malfunctions that might arise following use of water of deviating quality is excluded from liability by BINDER GmbH.

The humidity system is functional only if the freshwater bag is sufficiently filled. Check the filling level daily. The water reserve is sufficient for one up to two weeks, depending on the humidity demand (set humidity set-point, number of door openings).

For error indications concerning water supply and humidity system, see chap. 11 and 22.6.

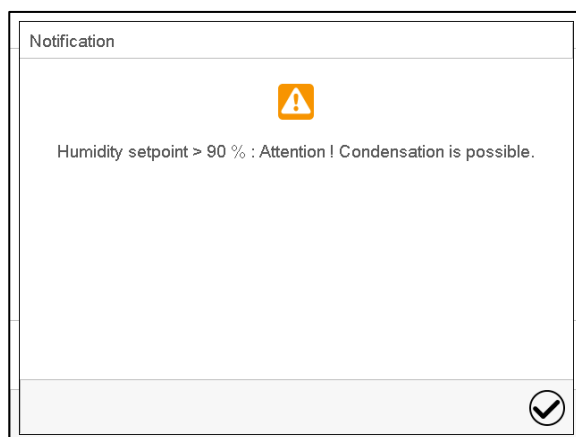

When entering a humidity setpoint value > 90 % r.h. a message window appears, indicating that condensation is possible.

Press the **Confirm** icon.

## 17.2 Function of the dehumidifying system

To reduce the humidity, ambient air is sucked in through a gas fine filter (sterile filter). As a result, the air in the interior is diluted with the air from outside. The air tube for inlet of the ambient air is located in the upper right corner in the recess for the freshwater bag. We recommend replacing the sterile filter on this tube about once a month. To replace the sterile filter, see chap. 22.2.3.

## 18. Options

### 18.1 APT-COM™ 4 Multi Management Software (option)

The chamber is regularly equipped with an Ethernet interface (5) that can connect the BINDER APT-COM™ 4 Multi Management Software. The MAC Address is indicated in the "Device info" controller menu (chap. 14.5.2.2). The actual values of temperature, CO<sub>2</sub>, O<sub>2</sub> (chamber with O<sub>2</sub> control) and humidity (CBF / CBF-UL) are given at adjustable intervals. Programming can be performed graphically via PC. Up to 100 chambers can be cross-linked. For further information on networking please refer to the operating manual of the BINDER communication software APT-COM™ 4.

### 18.2 Silicone access ports 30 mm / 1.18 in, closable from both sides with silicon plugs (option)

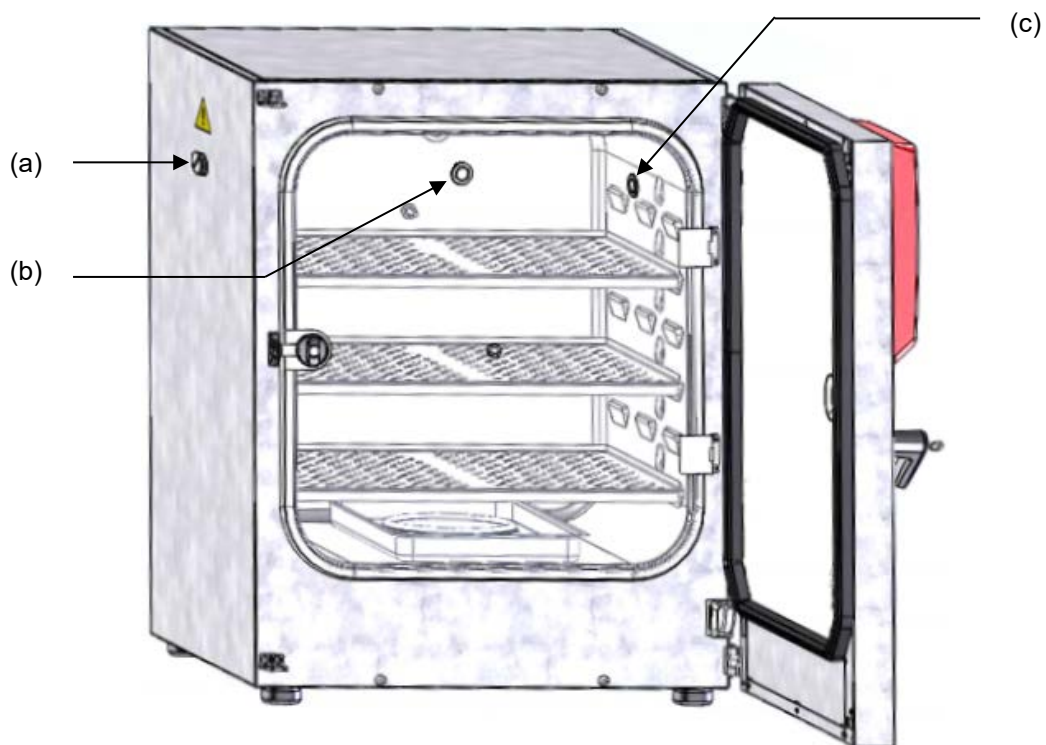





Figure 42: Positions of the optional silicon access ports left (a), rear (b), and right (c)

A warning sticker is located above each access port on the outside of the incubator.

When operating a chamber with silicon access ports, both silicon plugs must tightly close the access ports. If the plugs are inserted in a not-gastight manner, or if plugs are missing, CO<sub>2</sub> / O<sub>2</sub> / N<sub>2</sub> gas (chamber with O<sub>2</sub> control) may escape into the environment. The CO<sub>2</sub> control and the O<sub>2</sub> control (chamber with O<sub>2</sub> control) only turn off when the chamber door is opened.

	 <b>DANGER</b>
	<p><b>Danger of suffocation and poisoning by high concentration of CO<sub>2</sub> (&gt; 4 Vol.-%).</b>  <b>Death by suffocation.</b></p> <p>➤ Tightly close each access port with two plugs during operation.</p>

	 <b>DANGER</b>
	<p><b>Danger of fire and explosion through contact of combustible materials with O<sub>2</sub> with high concentration of O<sub>2</sub> (&gt; 21 % O<sub>2</sub>).</b>  <b>Serious injury or death from burns and / or explosion pressure.</b></p> <p>➤ Tightly close each access port with two plugs during operation.</p>

### 18.3 Quick sample access (option)



The quick sample access option provides easy access to the sample chamber through a small window in the glass inner door. This is a useful feature in applications with short incubation times. The window measures 13 x 25 cm and is located in the bottom corner of the glass inner door.

This quick method of accessing samples is available for both the standard door hinge on the right and the door hinge on the left.



Figure 43: Glass door (detail, example door hinge on the right) with Quick sample access option

## 18.4 Interior socket 230V (option, available via BINDER INDIVIDUAL Customized Solutions)

	<p>The interior socket is activated and deactivated in the controller via the switching state of an operation line (chap. 7.3, 9.7.3, 10.6.5). When the interior socket is activated, the notification “Interior socket” is shown highlighted in black next to the information icon in the screen header in Normal display (chap. 11.1.1)</p>	
---	---	---

The interior socket (H) is located at the upper left corner on the rear wall of the inner chamber. It is closed with a waterproof lid. The interior socket is suitable to supply electrical devices inside the chamber with 230V AC voltage.

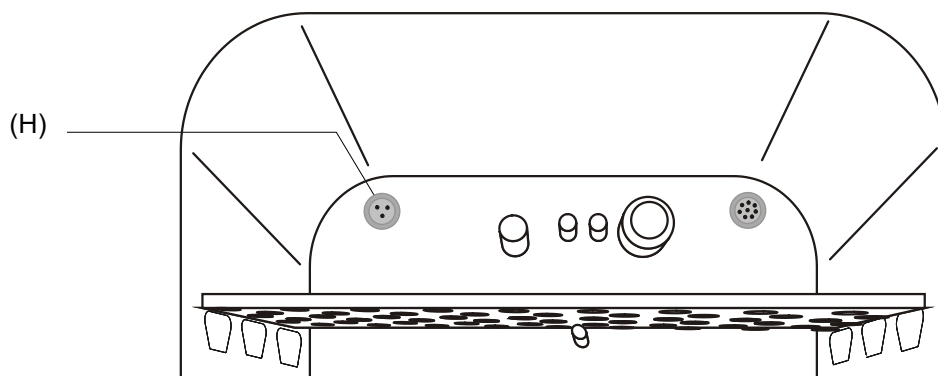



Figure 44: Position of the interior socket 230 V



(H) Interior socket

**The maximum head load must not exceed a capacity of 5 W.**

	<p style="text-align: center;"><b>NOTICE</b></p> <p><b>Danger of damage when exceeding the setpoint temperature.</b>  <b>Damage to the cultures.</b></p> <ul style="list-style-type: none"> <li>∅ Do NOT exceed the maximum head load of 5 W.</li> <li>∅ Do NOT connect equipment with a nominal capacity &gt; 5 W.</li> </ul>
---	--

	<p>Heat emission of electrical devices connected inside the CO<sub>2</sub> incubator may modify the temperature and humidity range. In general, any heat input leads to an increased tendency for condensation.</p>
---	---

**The maximum load must not exceed 3 Amp.**

	<p style="text-align: center;"> <b>DANGER</b></p> <p><b>Electrical hazard through overload of contacts.</b>  <b>Deadly electric shock. Damage to contacts and connection socket.</b></p> <ul style="list-style-type: none"> <li>∅ Do NOT exceed the maximum load of 3 A.</li> <li>∅ Do NOT connect any devices with a nominal current &gt; 3 A.</li> </ul>
---	---

The interior socket's voltage is turned off at the chamber controller via operation line (chap. 7.3, 9.7.3, 10.6.5).

Turning off the chamber at the main power switch also switches the interior socket voltage-free.

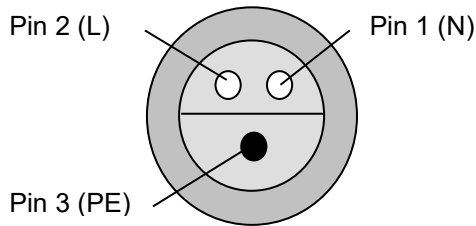

Figure 45: Interior socket (H) (front view)

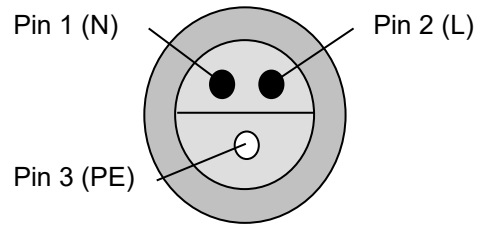



Figure 46: Supplied plug (front view)

Electrical data socket and plug: IP system of protection 65, 230 V 1N ~ 50-60 Hz

	<b>NOTICE</b>
	<p><b>Risk of short circuit caused by penetration of moisture into the socket.</b>  <b>Damage to the chamber.</b></p> <ul style="list-style-type: none"> <li>➤ Use the supplied plug only (IP protection type 65).</li> <li>➤ If the socket is not used, close it with the waterproof lid.</li> </ul>

When inserting a heat load into the inner chamber by introducing electrical devices such as shakers or rollers, the ambient temperature of the incubator must not exceed 25 °C / 77 °F. Otherwise, temperature control to 37 °C / 98.6 °F cannot be assured. When operating electrical devices inside the incubator, always check the desired incubation temperature **before** introducing any cells.

	<b>NOTICE</b>
	<p><b>Danger of excessive inner temperature &gt; 37 °C / 98.6 °F when operating electrical devices inside the incubator.</b>  <b>Damage to the cell cultures.</b></p> <ul style="list-style-type: none"> <li>➤ Make sure that the ambient temperature is ≤ 25 °C / 77 °F when operating electrical devices inside the incubator.</li> <li>➤ Check the temperature observation before introducing any cells.</li> </ul>

## 18.5 Analog outputs for temperature and CO<sub>2</sub> (option)

With this option, the chamber is equipped with analog outputs 4-20 mA for temperature and CO<sub>2</sub>. These outputs allow transmitting data to external data registration systems or devices.

The connection is realized as a DIN socket (4) on the chamber rear. A suitable DIN plug is enclosed.



### ANALOG OUTPUT 4-20 mA DC

PIN 1: Temperature +  
 PIN 2: Temperature -  
 PIN 3: CO<sub>2</sub> +  
 PIN 4: CO<sub>2</sub> -

CO<sub>2</sub> range: 0 vol.-% up to 20 vol.-%

Temperature range: 0 °C / 32 °F up to +200 °C / 392 °F

Figure 47: Pin configuration of the DIN socket (4) on the chamber rear

## 18.6 Access port for extra-low voltage (option)

The access port (B) (8-pin) for extra-low voltage (ELV) consists of a LEMO socket (which can be covered) and a LEMO connector. It is suitable to connect two electrical devices, one inside and one outside the incubator. You can use it e.g. for devices with a monitoring and control part remaining outside the incubator, whereas its mechanical component like roller or shaker systems is located inside the chamber.

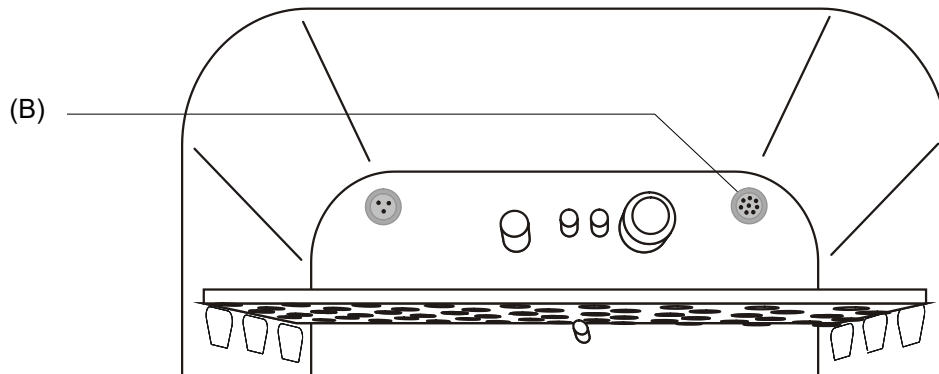

Figure 48: Position of the access port for extra-low voltage

### Maximum power rating 24V AC/DC 2Amp.

	<b>DANGER</b>
	<p><b>Electrical hazard through overload of contacts.</b>  <b>Deadly electric shock. Damage to contacts and connection socket.</b></p> <ul style="list-style-type: none"> <li>Ø Do NOT exceed the maximum load of 24V AC/DC 2Amp.</li> <li>Ø Do NOT connect any devices with a nominal current &gt; 2 Amp.</li> <li>Ø Do NOT connect any devices with a nominal voltage &gt; 24 V DC.</li> </ul>

<p>On chamber rear: Exterior Lemo socket (2) on the rear of the chamber</p>	<p>Interior: LEMO socket (B) located at the upper right corner of the rear wall of the inner chamber</p>	<p>Supplied LEMO connector: on external and internal side</p>

Figure 49: Pin allocation (front view) of the Lemo sockets and plug

When introducing a heat load into the inner chamber by inserting electrical devices like shakers or rollers, the ambient temperature of the incubator must not exceed 25 °C / 77°F. Otherwise, temperature control to 37 °C / 98.6°F cannot be assured. When operating electrical devices inside the incubator, always check the desired incubation temperature **before** introducing in any cells.

	<b>NOTICE</b>
	<p><b>Danger of excessive inner temperature &gt; 37 °C / 98.6 °F when operating electrical devices inside the incubator.</b></p> <p><b>Damage to the cell cultures.</b></p> <ul style="list-style-type: none"> <li>➤ Make sure that the ambient temperature is ≤ 25 °C / 77 °F when operating electrical devices inside the incubator:.</li> <li>➤ Check the temperature observation before introducing any cells.</li> </ul>

## 18.7 BINDER Gas Supply Service – External bottle changer for CO<sub>2</sub>, N<sub>2</sub> or O<sub>2</sub> (option)

The external bottle changer permits automatic switching to a second gas cylinder as soon as the first cylinder is empty. It can be used for a maximum of two CB chambers.

	<p>Instructions 7001-0196 delivered with the external bottle changer (Art. no. 8012-0408) describe its installation and operation.</p>
---	--

## 18.8 Stands

### 18.8.1 Flat stacking adapter for thermally decoupled stacking (option)

We recommend not stacking the incubators directly on top of one another in order to avoid transmission of shocks and vibrations from one chamber to the other. This could happen e.g. while opening or closing the door, cleaning, charging and discharging the chamber. BINDER offers a flat stacking adapter for the safe stacking of two BINDER CO<sub>2</sub>-incubators.

The stacking adapter ensures that the set incubation parameters are precisely maintained also during sterilization of the other chamber (chap. 21.3) by thermal decoupling.

Art. No. 9051-0038 for incubator size 56, Art. No. 9051-0035 for incubator size 170, Art. No. 9051-0039 for incubator size 260.

	<p>The mounting instructions 7001-0294 delivered with the stacking adapter describe its installation.</p>
---	---

### 18.8.2 Stacking stand on castors with castors lockable by breaks (option)

We recommend not stacking the incubators directly on top of one another in order to avoid transmission of shocks and vibrations from one chamber to the other. This could happen e.g. while opening or closing the door, cleaning, charging and discharging the chamber. BINDER offers stable, vibration-free stands with castors (2 lockable by brakes) for the safe stacking of two BINDER CO<sub>2</sub>-incubators.

The stacking stand ensures that the set incubation parameters are precisely maintained also during sterilization of the other chamber in the same stacking stand (chap. 21.3) by thermal decoupling.

Using the stacking stand offers more advantages: You can pull the lower chamber forward separately (e.g., for access to the rear), and not have to place it directly on the floor (important for sanitary purpose).

Art. No. 9051-0020 for incubator size 170, Art. No. 9051-0041 for incubator size 260.



The mounting instructions 7001-0194 delivered with the stacking stand describe its installation.

### 18.8.3 Base on castors (option)

In order to obtain easy access to the chamber, for safe placement and leveling of a BINDER CO<sub>2</sub> incubator, and to avoid contamination of the chamber caused by soil pollution, BINDER recommends using the base on castors.

Art. No. 9051-0043 for incubator size 56, Art. No. 9051-0028 for incubator size 170, Art. No. 9051-0044 for incubator size 260.



The mounting instructions 7001-0147 delivered with the base on castors describe its installation.

## 18.9 Water supply sets (optional for CBF / CBF-UL)

### 18.9.1 Tubular bag set (option)

For the water supply via freshwater bag (standard), a set with 12 tubular bags (annual demand) is available. The bag set includes all necessary connecting parts.

For details please refer to chap. 4.5.2.

### 18.9.2 Humidification water set (option)

For the optional water supply via prefilled water bottle, a humidification water set with 10 prefilled one-liter bottles (annual demand) is available. It includes all necessary connecting parts. For details please refer to chap. 4.5.3.

By using the humidification water set you will achieve unsurpassed contamination safety of your samples in the BINDER CO<sub>2</sub> incubator CBF / CBF-UL.

### 18.9.3 Water container set (option)

The fresh water can, which is placed in an included magnetic can holder on the left chamber side, serves to supply one or several chambers with freshwater for humidification.

The water container set includes all necessary connecting parts. For details please refer to chap. 4.5.4.

## 19. Reference measurements

Reference measurements of the temperature, CO<sub>2</sub>, O<sub>2</sub> (chamber with O<sub>2</sub> control), and humidity can be performed via the silicone measuring port (K) located on the inner glass door. Reference temperature measurements always take place under equilibrated conditions with both doors closed.



## 19.1 CO<sub>2</sub> reference measuring

There are three possibilities to perform CO<sub>2</sub> test measurements between the recommended annual maintenance procedures. To test the CO<sub>2</sub> concentration inside an incubator, see chapters 19.1.1 to 19.1.3.

### 19.1.1 Measuring CO<sub>2</sub> concentration indirectly via the pH of the cell medium

By using the indirect determination of CO<sub>2</sub> concentration via the pH-value of the nutrient, it is possible to check the CO<sub>2</sub> concentration inside the chamber. This is a simple method to test the correct CO<sub>2</sub> concentration without any special CO<sub>2</sub> measuring equipment. You need only use an accurate pH indicator or a pH-measuring electrode, which are standard equipment in cell culture laboratories.

This method is based on the acid base equilibrium of the buffer system in the culture media. NaHCO<sub>3</sub> buffers the common media. From the pH value of the medium, it is possible to conclude its CO<sub>2</sub> concentration. Figure 50 shows the relationship between CO<sub>2</sub> concentration in vol.-% and the pH of different NaHCO<sub>3</sub> buffered media.



These test systems are not suitable for calibrating the BINDER sensor system.

#### Recommended procedure:

- Incubate an empty sample with medium for 1/2 day under the same conditions as the cells. You can perform the incubation in a cell culture cylinder or in a 50 ml Falcon tube with open lid.
- After gassing, remove the empty sample from the incubator and within 5 minutes measure the pH-value with a glass electrode.

During the measurement, the medium should have the least possible surface contact with the ambient air, so that the CO<sub>2</sub> can evaporate only slightly. A significant downward movement will happen only after 5 minutes, permitting sufficient time for measurement.

- In addition, you can of course use pH-test strips (pH range 6 to 8, not bleeding).

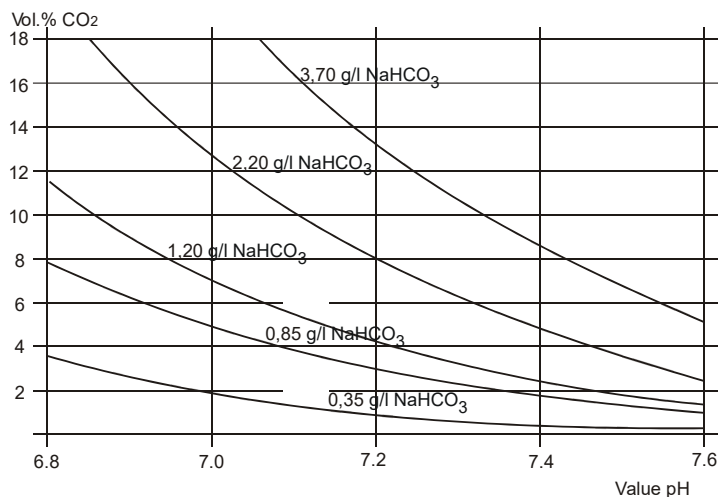

#### Trade names of common media:

	NaHCO <sub>3</sub> [g/l]
DMEM	3.70
BME	2.20
MEM	2.20
Medium 199	2.20
Mc Coy	2.20
F10	1.20
F12	1.20

Figure 50: Value pH of NaHCO<sub>3</sub> buffered media as a function of the CO<sub>2</sub> concentration:

Example: If a pH of 7.2 is measured in a medium buffered with 2.20 g NaHCO<sub>3</sub> per liter, there must be 8 vol.-% CO<sub>2</sub> surrounding this medium.

### 19.1.2 Measuring CO<sub>2</sub> directly via chemical indicator tubes

This is a common “do-it-yourself” test for many users. A chemical color reaction in a glass tube shows the CO<sub>2</sub> concentration. A standardized volume of air from inside the incubator has to be suctioned through this glass tube to get a quantitative test result. Therefore, use a special hand pump with a standardized suction volume.

#### Procedure (example):

All the necessary equipment must be supplied by one manufacturer only and in a defined test system.

Note: These test systems are not very accurate. A typical accuracy is around 10 % of the full-scale value.



These test systems are not suitable for calibrating the BINDER sensor system.

### 19.1.3 Measuring CO<sub>2</sub> directly with an electronic infrared measuring device

Another possible way of measuring the CO<sub>2</sub> concentration is by electronic sensor systems. Portable measuring devices are suitable for measuring temperature and CO<sub>2</sub> concentration and can be used both for reference measurements in certified laboratories, and for service purposes.

## 19.2 Temperature reference measurement

When performing a temperature reference measurement using an electronic measuring, and temperature display device, it is important to use a device traceable to an acknowledged standards/calibration institution (DKD, PTB for Germany) with a valid calibration certificate.

Note: The cable of the sensor must be thin enough to lay it over the door gasket of the incubator without causing any leakages.

## 20. Avoiding microbial contamination

The main types of microbial contaminants in cell and tissue culture are bacteria, fungi, yeast, mycoplasma, and viruses. This chapter gives an overview of potential sources of contamination and precautions and measures to eliminate them.

### 20.1 Cells and media

- Primary cultures from the original tissue
- Cells / cell lines from unknown sources or from cell banks: Use only cells of known and tested origin. Monitoring and routine screening of new cultures.
- Media and sera: Use only sera of known and tested origin (mycoplasma free, e.g., UV or  $\gamma$  radiated).
- Virus suspensions, antibody solutions etc. Use only reagents of known and tested origin.
- Laboratory instruments, media and reagents that were exposed to possible contaminated cultures must be sterilized / autoclaved / disposed.
- Antibiotics in the cell culture media may prevent bacteria detection: Use antibiotics selectively and economically.

---

## 20.2 Laboratory conditions / equipment around the incubator

Possible sources of contamination in the cell culture lab are airborne germs, lab equipment, building features, and the lab personnel.

- Keep pipettes and instruments sterile after autoclaving.
- Bio safety cabinets (laminar air flow) should have a minimum of items apart from aspirator tube and burner. Items shall be positioned within easy reach and separate from each other. Disinfect surfaces with an alcohol-based disinfectant before and after use, clean the space underneath the bench, and carry out regular sterility tests of the filters.
- Regular cleaning / disinfection of laboratory equipment such as a centrifuge, microscope, water bath, refrigerator, and telephone.
- No equipment should be placed on the floor.
- Rough or humid walls are not suitable.
- Identify leaking doors and windows and make them airtight.
- Use air conditioning with special filters.
- Reduce the number of personnel and their movements in the lab by careful positioning all relevant equipment. For practical reasons, install the chamber close to the laminar air flow bench.
- Regular microbiological monitoring of the cell culture laboratory.

## 20.3 Working and behavior in the lab

Sources of contamination are often the laboratory personnel themselves (surface germs, oral flora droplet transfer) and handling the equipment and cultures. We recommend staff training in aseptic techniques, laboratory safety and good laboratory practice (GLP).

### Examples of general rules to reduce the contamination risks

- Reduce hand germ count (wash hands with antimicrobial soap, dry with paper tissues, and rub dry hands with alcohol-based solution).
- Wear appropriate clothing (work coat, shoes, face mask)
- Keep as few personnel as possible in the cell culture lab.

### Examples of sterile working method

- Work "clean-to-dirty", i.e., handle confirmed uncontaminated cells first, unknown or untested cells next, and lastly, if necessary, cells suspected to be contaminated.
- Perform daily microscopic observations of cultures and specific tests for the bacteria and fungi as part of a controlled routine. Test cultures for sterility before starting work.
- Keep working surfaces clean. Immediately wipe spilled liquids with alcohol solutions.
- No mouth contact on pipettes.
- Never work on top of open sterile containers.

## 20.4 Chamber design and equipment of the CO<sub>2</sub> incubator

The design concepts behind the CO<sub>2</sub> incubator considerably reduce the risk of contamination. Among them are:

### Even surfaces for easy manual cleaning

- The inner surfaces are smooth and therefore easy to clean. The inner chamber is deep-drawn from a single piece, polished (suitable for pharmaceutical work) and has no welds or inaccessible corners. The hinges and the seal of the inner glass door are glued from the outside, which also aids cleaning of the inner chamber.

---

### **Removable parts for cleaning and autoclaving**

- The shelves are easily removed without screws. It is possible to autoclave the shelves. But this is generally not necessary because they can remain inside the chamber during sterilization.

### **Door gasket**

- The inner door gasket is removable and autoclavable.

### **Gas fine filter**

- The incoming gas used in the operation passes through a fine filter (aseptic filter, filtration efficiency 99.99 %, particle size 0.45 µm) with a high filtration efficiency, which can also filter the smallest particles.

### **CO<sub>2</sub> measuring system in the inner chamber**

- The CO<sub>2</sub> sensor can be hot-air sterilized inside the chamber.

### **O<sub>2</sub> measuring system in the inner chamber (chamber with O<sub>2</sub> control)**

- The O<sub>2</sub> sensor can be hot-air sterilized inside the chamber.

### **Humidity measuring system in the inner chamber (CBF / CBF-UL)**

- The humidity sensor can be hot-air sterilized inside the chamber.

### **Condensation prevention**

- Condensation in the inner chamber represents a particular risk of contamination. The Permadyr™ system (CB / CB-UL) developed by BINDER is an effective and easy way to ensure high humidity (≥95 % r.h.) inside the chamber without any condensation forming on the inner surfaces.

### **Hot air sterilization**

- The heating system of the CO<sub>2</sub> incubator permits hot-air auto-sterilization at a setpoint of 180 °C / 356 F. Thus, the effective sterilization temperature is maintained for at least two hours on all internal surfaces, resulting in sterilization of the entire inner chamber.

## **20.5 Handling the CO<sub>2</sub> incubator**

Any manipulation of the CO<sub>2</sub> incubator involves some contamination risks, from installation to opening the doors and regular cleaning.

### **Installation away from sources of contamination**

- Do not place the chamber on the floor or close to windows and doors. Use the optional stand, if appropriate.

### **Reduce the periods in which the door is open**

- Do not open the door too frequently.
- Placing items in order inside the chamber results in shorter door opening times.

### **Permadyr™ water pan (CB / CB-UL)**

- Fill the outer pan with distilled, sterilized water (chap. 4.2). Never use ion exchange water; ion exchangers are propagation sites for bacteria.
- Clean and refill the pans 2 to 3 times a week. For evacuation, remove the Permadyr™ water pan. It is autoclavable.
- If desired, you can add microbiologically inhibiting substances as copper chips, copper sulfate or ethylene diamine tetra-vinegar acid (EDTA) in a concentration of 1 to 5 mmol/l.

### **Avoiding condensation caused by ambient conditions**

Ambient room conditions have an effect on condensation inside the chamber, which can be caused by insufficient wall clearances, preventing even dissipation of heat, air movement or direct sunlight. If the temperature distribution inside the chamber becomes uneven, condensation may form on the cooler surfaces.

- Maintain distances from the wall: rear 100 mm / 3.94 in, sides 50 mm / 1.97 in
- Do not place the chamber in front of a window. No direct sunlight. No air movement.
- Permissible ambient temperature range for operation: +18 °C / 64.4°F to +30 °C / 86°F.  
Ideal ambient temperature: by at least 7 °C / 12.6 °F below the intended working temperature. E.g., working temperature 37 °C / 98.6 °F = ambient temperature 30 °C / 86 °F and less.
- The chamber should be calibrated / precisely adjusted.
- Let BINDER Service adjust the setting of the door heating in reaction to critical ambient conditions.

#### Regular cleaning, decontamination and sterilization

- Clean the shelves, glass door, gaskets, and inner chamber weekly (for cleaning see chap. 21.1, for decontamination see chap. 21.2. You can clean the shelves in a laboratory dishwasher and, if needed, individually autoclave them.
- Regularly use the hot air sterilization function (chap. 21.3) following cleaning. The shelves and the emptied water pan (CB / CB-UL) can remain inside the chamber during this operation.
- Have replaced the CO<sub>2</sub> sterile filter (gas fine filter) once or twice a year.





#### What to do in case of contamination?



- Throw away / autoclave contaminated cultures.
- Carefully inspect cultures that seem to be uncontaminated.
- Clean the chamber as described. Wipe the inner chamber and the doors with a disinfectant and allow drying. Autoclave the shelves. Empty the water pan and autoclave it (CB / CB-UL).
- Perform a hot air sterilization.

## 21. Cleaning, decontamination / disinfection, and sterilization

Clean the chamber after each use in order to prevent potential corrosion damage by ingredients of the charging material.

Prior to renewed startup, allow the chamber to completely dry after all cleaning and decontamination measures.

  	 <b>DANGER</b>
<p><b>Electrical hazard by water entering the chamber.</b>  <b>Deadly electric shock.</b></p> <ul style="list-style-type: none"> <li>Ø Do NOT spill water or cleaning agents over the inner and outer chamber surfaces.</li> <li>Ø Do NOT put ANY cleaning aids (cloth or brush) into slots or openings on the chamber.</li> <li>➤ Before cleaning, turn off the chamber at the main power switch and disconnect the power plug. Let the chamber cool down to ambient temperature.</li> <li>➤ Completely dry the chamber before turning it on again.</li> </ul>	

	 <b>DANGER</b>
	<p><b>Danger of explosion due to cleaning agents on hot surfaces.</b>  <b>Serious injury or death from burns and / or explosion pressure.</b></p> <ul style="list-style-type: none"> <li>➤ Before cleaning, turn off the chamber at the main power switch and disconnect the power plug.</li> <li>➤ Before cleaning, let the chamber cool down to ambient temperature.</li> <li>➤ Completely dry the chamber before turning it on again.</li> </ul>

## 21.1 Cleaning

Disconnect the chamber from the power supply before cleaning. Disconnect the power plug.

	<p>The interior of the chamber must be kept clean. Thoroughly remove any residues of the charging material.</p>
---	---

Wipe the surfaces with a moistened towel. In addition, you can use the following cleaning agents:

<p>Exterior surfaces, instrument panel</p>	<p>Standard commercial cleaning detergents free from acid or halides.          Alcohol-based solutions.          We recommend using the neutral cleaning agent Art. No. 1002-0016.</p>
<p>Inner chamber, shelves, fresh water can (option)</p>	<p>Standard commercial cleaning detergents free from acid or halides.          Copper sulfate solutions or alcohol-based solutions.          We recommend using the neutral cleaning agent Art. No. 1002-0016.</p>
<p>Silicone door gasket</p>	<p>Alcohol-based solutions or the neutral cleaning agent Art. No. 1002-0016.</p>
<p>Zinc coated hinge parts rear chamber wall</p>	<p>Standard commercial cleaning detergents free from acid or halides.          Do NOT use a neutral cleaning agent on zinc coated surfaces.</p>

Do not use cleaning agents that may cause a hazard due to reaction with components of the device or the charging material. If there is doubt regarding the suitability of cleaning products, please contact BINDER service.

	<p>We recommend using the neutral cleaning agent Art. No. 1002-0016 for thorough cleaning.          Any corrosive damage that may arise following use of other cleaning agents is excluded from liability by BINDER GmbH.          Any corrosive damage caused by a lack of cleaning, is excluded from liability by BINDER GmbH.</p>
---	--

	<b>NOTICE</b>
	<p><b>Danger of corrosion by using unsuitable cleaners.</b>  <b>Damage to the chamber.</b></p> <ul style="list-style-type: none"> <li>∅ Do NOT use acidic or chlorine cleaning detergents.</li> <li>∅ Do NOT use a neutral cleaning agent on other kind of surfaces e.g., the zinc coated hinge parts or the rear chamber wall.</li> </ul>

To maintain the proper function of the CO<sub>2</sub> sensor, never spray the sensor with any cleaning detergents or disinfectants.

	NOTICE
	<p><b>Damage to the CO<sub>2</sub> sensor due to unsuitable cleaning procedures.</b></p> <p><b>Damage to the chamber.</b></p> <ul style="list-style-type: none"> <li>⊘ NEVER spray any cleaning detergents directly on the CO<sub>2</sub> sensor.</li> <li>➤ Wipe the sensor with a lint-free cloth soaked with cleaning agent.</li> </ul>

Use only the detergents or disinfectants recommended by BINDER. Other products are not approved, since they could in particular damage the CO<sub>2</sub> sensor.

	<p>For surface protection, perform cleaning as quickly as possible.</p> <p>After cleaning completely remove any cleaning agents from the surfaces by using a moistened towel. Let the chamber dry.</p>
---	--



	<p>Soapsuds may contain chlorides and must therefore NOT be used for cleaning.</p>
---	--

	<p>With every decontamination method, always use adequate personal safety controls.</p>
---	---

Following cleaning, leave the chamber door open or remove the access port plugs.

	<p>The neutral cleaning agent may cause health problems in contact with skin and if ingested. Follow the operating instructions and safety hints labeled on the bottle of the neutral cleaning agent.</p>
--	---

Recommended precautions: To protect the eyes use sealed protective goggles. Wear gloves. Suitable protective gloves in full contact with media: butyl or nitrile rubber, penetration time >480 minutes.

	 <b>CAUTION</b>
<p><b>Danger of chemical burns through contact with skin or ingestion of the neutral cleaning agent.</b></p> <p><b>Skin and eye damage. Environmental damage.</b></p> <ul style="list-style-type: none"> <li>⊘ Do not ingest the neutral cleaning agent. Keep it away from food and beverages.</li> <li>⊘ Do NOT empty the neutral cleaning agent into drains.</li> <li>➤ Wear protective gloves and goggles.</li> <li>➤ Avoid skin contact with the neutral cleaning agent.</li> </ul>	

	<p>Following use of the neutral cleaning agent and prior to hot-air sterilization, remove any agent residues by using a moistened towel in order to avoid formation of permanent residues.</p>
---	--

## 21.2 Decontamination / chemical disinfection of the chamber

The operator must ensure that proper decontamination is performed in case a contamination of the chamber by hazardous substances has occurred.

Disconnect the chamber from the power supply prior to chemical decontamination. Disconnect the power plug.

Do not use decontamination agents that may cause a hazard due to reaction with components of the device or the charging material. If there is doubt regarding the suitability of cleaning products, please contact BINDER service.

You can use the following disinfectants:

Inner chamber	Standard commercial surface disinfectants free from acid or halides. Alcohol based solutions. We recommend using the disinfectant spray Art. No. 1002-0022.
Fresh water can (option)	Rinse with 70° Ethanol



For chemical disinfection, we recommend using the disinfectant spray Art. No. 1002-0022. Any corrosive damage that may arise following use of other disinfectants is excluded from liability by BINDER GmbH.



With every decontamination method, always use adequate personal safety controls.





In case of contamination of the interior by biologically or chemically hazardous material, there are two possible procedures depending on the type of contamination and charging material.

- Spray the inner chamber with an appropriate disinfectant.  
Before start-up, the chamber must be absolutely dry and ventilated, as explosive gases may form during the decontamination process.
- If necessary, have strongly contaminated inner chamber parts removed by an engineer for cleaning, or have them exchanged. Sterilize the inner chamber parts in a sterilizer or autoclave.



In case of eye contact, the disinfectant spray may cause eye damage due to chemical burns. Follow the operating instructions and safety hints labeled on the bottle of the disinfectant spray.

Recommended precautions: To protect the eyes use sealed protective goggles.

   	 <b>CAUTION</b>
<p><b>Danger of chemical burns through eye contact with the disinfectant spray.</b></p> <p><b>Eye damage. Environmental damage.</b></p> <ul style="list-style-type: none"> <li>⊘ Do NOT empty the disinfectant spray into drains.</li> <li>➤ Wear protective goggles.</li> </ul>	



Following frequent use of the disinfectant spray and prior to hot-air sterilization, remove any agent remainder by using the neutral cleaning agent and then a moistened towel to avoid formation of permanent residues.



After using the disinfectant spray, allow the chamber to dry thoroughly, and aerate it sufficiently.



### 21.2.1 Disinfection of the CO<sub>2</sub> sensor

To ensure proper disinfection and function of the CO<sub>2</sub> sensor, BINDER recommends wiping the sensor head with pure alcohol or a non-corrosive, acid and chlorine-free alcohol based surface disinfectant. We recommend using the disinfectant spray Art. No. 1002-0022.

Important: To maintain the proper function of the CO<sub>2</sub> sensor, never spray the sensor with any cleaning detergents or disinfectants. Generally perform any disinfection only when the chamber is turned off. The sensor may be only superficially disinfected with a damp cloth. The hot air sterilization routine is intended for a thorough sterilization of the entire chamber.

	<b>NOTICE</b>
	<p><b>Danger of damage to the CO<sub>2</sub> sensor due to unsuitable disinfection procedures.</b></p> <p><b>Damage to the CO<sub>2</sub> sensor.</b></p> <ul style="list-style-type: none"> <li>⊘ NEVER spray the disinfectant directly on the CO<sub>2</sub> sensor.</li> <li>➤ Wipe the sensor with a lint-free cloth soaked with the disinfectant.</li> </ul>

Use only the detergents or disinfectants recommended by BINDER. Other products are not approved, since they could in particular damage the CO<sub>2</sub> sensor.

### 21.2.2 CBF / CBF-UL: Disinfection of components of the fresh water supply system

Freshwater is supplied by manually filling a freshwater bag (tubular bag set, standard, can be reordered) or a freshwater can (optional water container set). It is also possible to connect prefilled water bottles (optional humidification water set).

The freshwater bag can be refilled several times, but should be replaced from time to time for hygienic reasons.

The silicone tubes and tube connectors can be autoclaved. They can also be replaced for hygienic reasons.

For the fresh water can we recommend thorough cleaning using a recommended cleaning agent (chap. 21.1) followed by rinsing with 70 % ethanol.

## 21.3 Hot-air sterilization

	<p>The very first sterilization after operation may cause an odor. This is not a quality defect. We recommend ventilating well the room during sterilization.</p>
---	---

### 21.3.1 Overview

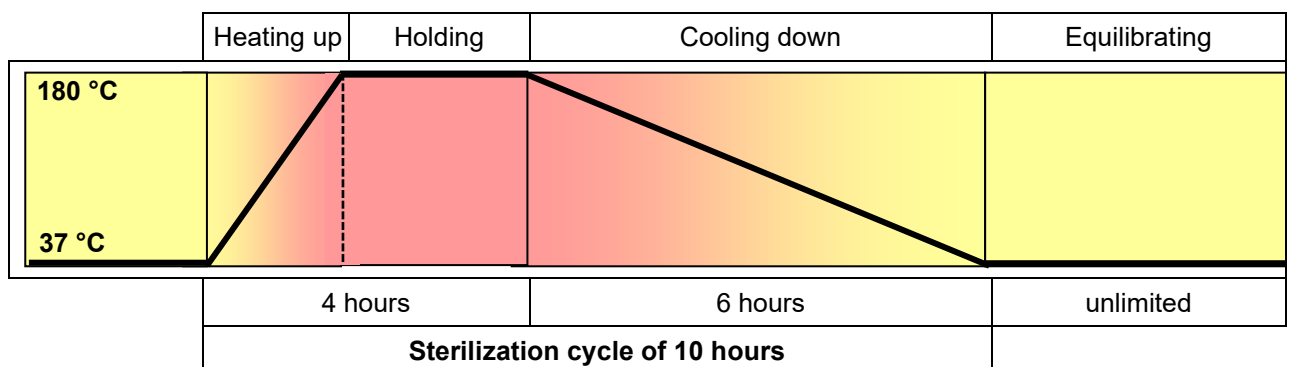

Figure 51: Setpoint profile during the sterilization cycle

The chamber can perform an automatically controlled hot-air sterilization cycle. This procedure of 10 hours consists of the following steps:

- **Heating up phase:** The chamber heats up the inner chamber as fast as possible to the sterilization setpoint temperature
- **Holding phase:** Constant sterilization setpoint temperature  
The sterilization setpoint temperature is pre-set in factory to 180 °C / 356 °F. The duration of the heating up and holding phase is in total 4 hours. This ensures that the effective sterilization temperature is maintained on all internal surfaces for at least 2 hours. The effectiveness of the sterilization has also been confirmed by an independent research institute.
- **Cooling down phase:** Programmed duration of 6 hours until 37 °C / 98.6°F is reached
- Then follows an **equilibration phase:** After the 10-hour sterilization cycle the controller changes to fixed value operation mode and equilibrates to the set-point which has been entered there (e.g., 37 °C / 98.6 °F).

Note: in the case when two chambers are directly stacked on top of each other **without** using the original BINDER stacking stand or the BINDER stacking adapter, the exact maintenance of the incubation set parameters in one of the chambers while carrying out sterilization in the other one cannot be assured. Therefore, without using the stacking stand or the stacking adapter, safe incubation is not possible during sterilization of the other chamber. We recommend using a stacking stand (chap. 18.8.2).

CO<sub>2</sub> / O<sub>2</sub> control is deactivated during the sterilization cycle. To activate gas control, the following conditions are required:

- Completing or prematurely terminating the sterilization cycle and confirming the corresponding information message
- Inner chamber temperature below 80 °C

	If the temperature exceeds < 80 °C, gas control will remain deactivated even after completing or prematurely terminating the sterilization cycle. Only after the temperature has decreased below 80 °C, gas control will turn on again.
---	--

### 21.3.2 Preparation for a hot-air sterilization



	Before carrying out the first hot-air sterilization, remove any protective lamination sheet from the inner metal surfaces.
---	--

	When starting a hot-air sterilization, all gas controls automatically deactivate.
---	---

	The safety controller settings are inactive during sterilization. They become functional again following completing or prematurely terminating of the sterilization cycle and/or restart of the chamber at the main power switch.
---	---

	The O <sub>2</sub> sensor must be plugged in during a hot-air sterilization.
---	--

- Empty the Permadyr™ water pan (CB / CB-UL).

	 <b>WARNING</b>
	<b>Danger of implosion caused by a filled water pan during sterilization. Destruction of the chamber.</b> ➤ Empty the Permadyr™ water pan before starting the hot-air sterilization.

- Water pans (CB / CB-UL) and shelves must be inside the chamber.
- Close the inner glass door and the outer chamber door.



Before starting a hot-air sterilization, the entire interior must be clean and dry. No residue of e.g., water, medium or plastic must remain inside the chamber.

### 21.3.3 Starting the sterilization cycle and running the hot-air sterilization



In Normal display press the **Program start** icon to access the “Program start” menu.

Program start		20:40:01
Program type	Time program	▼
Program	Sterilisation	▼
Start section	1	
Program duration		
Program start	2015/02/08 20:39:51	
Program end	2015/02/08 20:40:07	
Program info		
<input type="checkbox"/> <input checked="" type="checkbox"/>		

“Program start” menu

- In the field “Program type” select the setting “Time program”.
- In the field “Program” select the program “Sterilization”.
- Select the field “Program start” and enter the desired program start time in the “Program start” entry menu. Press the **Confirm** icon.

A confirmation prompt is displayed.

Fixed value		09:01:15
Program start		
<p>Samples and water removed? Start sterilization?</p>		
<input type="checkbox"/> <input checked="" type="checkbox"/>		

Make sure that the water pan was emptied (CB / CB-UL) and all samples were removed from the chamber and press the **Confirm** icon to confirm the message.



The controller returns to the initial view and the program delay time until program start begins.

When the program delay time is over, the hot-air sterilization cycle begins.

Confirmation prompt.

Sterilisation			
		Setpoint	Actual value
Temperature	°C	180.0	180.0
CO2	%	0.0	-----
O2	%	21.0	-----
Humidity	%RH	50.0	-----
Program		Sterilization	
Program runtime		00:13:41	

Normal display with alarm message "Sterilization".  
The sterilization is running.  
The zero-voltage relay alarm output and the buzzer are not activated.

Opening the outer door leads to prematurely terminating the running sterilization cycle. If this happens during the heating up or holding phase (during 4 hours after starting the sterilization cycle), sterilization will be ineffective (chap. 21.3.4.1).

	NOTICE
	<p><b>Danger of interrupting the temperature reaction time by opening the outer door during the heating up or holding phase.</b> <b>Ineffective sterilization.</b></p> <p>⊘ Do NOT open the chamber doors during the heating up or holding phase of the sterilization cycle</p>

Glass door and inner chamber become hot during sterilization.

	CAUTION
	<p><b>Danger of burning by touching hot chamber parts during a sterilization.</b> <b>Burns.</b></p> <p>⊘ Do NOT touch the inner surfaces, inner doors, inner door handles, and door gaskets during a sterilization.</p>

Note: Since the stored sterilization program cannot be changed, it is not accessible via the program path [Main menu > Programs > Time program](#).

The sterilization program must not be interrupted using the **Program pause** icon.

	NOTICE
	<p><b>Danger of interrupting the temperature reaction time by pausing the sterilization program during the heating up or holding phase.</b> <b>Ineffective sterilization.</b></p> <p>⊘ DO NOT interrupt a running sterilization program during the heating up or holding phase of the sterilization cycle.</p> <p>➤ If necessary, repeat the sterilization.</p>

### 21.3.4 Prematurely terminating the sterilization cycle

Three events lead to terminating the sterilization cycle prematurely:

- Cancelling the program via the controller menu  
To prematurely terminate the sterilization cycle via the controller menu, press the **Program cancelling** icon and confirm the confirmation prompt with the **Confirm** icon (chap. 9.2.2).
- Opening the outer door
- Turning off the chamber at the main power switch, or a power failure

Prematurely terminating the sterilization cycle means terminating it before the entire 10-hour duration is completed. Whether effective sterilization has occurred depends on the time that has elapsed before.

#### 21.3.4.1 Prematurely terminating the sterilization cycle after less than 4 hours: Ineffective sterilization

After prematurely terminating the sterilization cycle after less than 4 hours, the information "Sterilization failed" is shown on the controller display.

The interior may still be hot. Do not touch the glass door and inner surfaces!

Confirm the message with the **Confirm** icon.

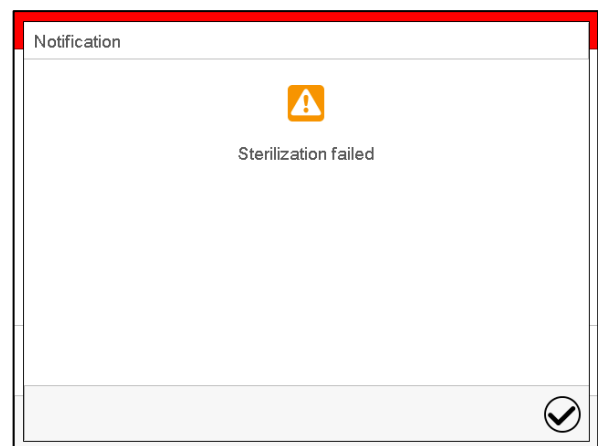

After confirming the message the controller changes to Fixed value operation mode. The setpoints of Fixed value operation mode are then equilibrated.



CO<sub>2</sub> / O<sub>2</sub> control is deactivated and will only be activated after confirming the information message "Sterilization failed" and when the temperature has cooled down to a value below < 80 °C.

When prematurely terminating the sterilization cycle, it may be that the cells/pathogens inside the chamber have not all been killed. If necessary, you should repeat the sterilization.



#### NOTICE

**Danger of interrupting the temperature reaction time by prematurely terminating the sterilization.**

**Ineffective sterilization.**

- If necessary, repeat the sterilization.

The glass door and inner chamber become hot during sterilization.



#### CAUTION

**Danger of burning by touching hot chamber parts during or after a sterilization. Burns.**

- ⊘ Do NOT touch the glass door and inner surfaces for approx. 7 hours after prematurely terminating the sterilization cycle.

### 21.3.4.2 Prematurely terminating the sterilization cycle after more than 4 hours, i.e., during the cooling-down phase: successful sterilization

The duration of the entire sterilization is 10 hours. If you want to shorten the sterilization procedure in order to save time, you can prematurely terminate it during the cooling-down phase, i.e. no sooner than after 4 hours. At this point, the inner temperature is still approx. 140 °C / 284 °F.

The effective sterilization phase (heating up and holding phase) is automatically finished after 4 hours. The chamber is in the cooling-down phase, meaning that the necessary duration for the proper sterilization has occurred.

The information "Successful sterilization" on the controller display indicates a successful hot-air sterilization.

The interior may still be hot. Do not touch the glass door and inner surfaces!

Confirm the message with the **Confirm** icon.

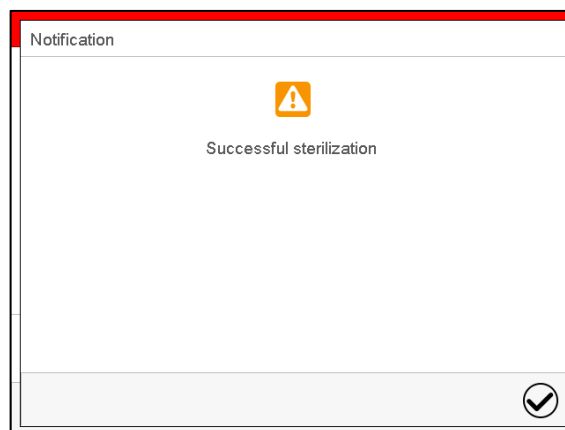

After confirming the message the controller changes to Fixed value operation mode. The setpoints of Fixed value operation mode are then equilibrated.



CO<sub>2</sub> / O<sub>2</sub> control is deactivated and will only be activated after confirming the information message "Successful sterilization" and when the temperature has cooled down to a value below < 80 °C.

If you prefer accelerating cooling-down, proceed as follows:

- If required, open the outer door.
- Cooling-down time:
  - Front door open: at least 1 hour
  - Front door closed: at least 4 hours
- If required, open the glass door.

Glass door and inner chamber become hot during sterilization. The glass door handle reaches a temperature of approx. 150 °C / 302 °F.



#### CAUTION

**Danger of burning through touching the glass door and inner chamber during or after a sterilization.**

#### Burns.

- ⊘ Do NOT touch the glass door and inner surfaces.
- Use gloves or a tool (e.g. pincers) to open the glass door.

### 21.3.5 Completing the entire sterilization cycle

The effective sterilization phase (heating up and holding phase) is automatically finished after 4 hours.

Now the information “Successful sterilization” on the controller display indicates a successful hot-air sterilization.

Confirm the message with the **Confirm** icon.

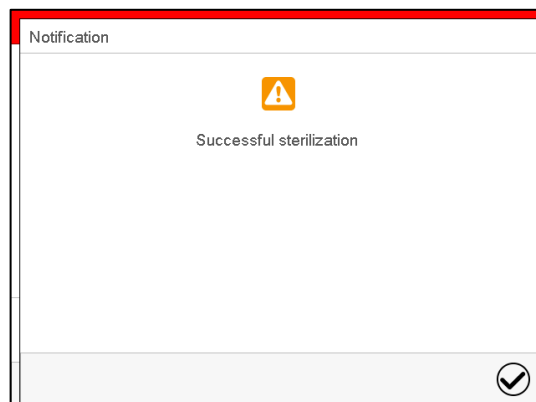

It is followed by a defined 6-hours cooling down phase until 37 °C / 98.6 °F is reached. After this sterilization cycle of 10 hours in total, the controller changes to fixed value operation mode and equilibrates to the set-point which has been entered there (e.g., 37 °C / 98.6 °F).

	<p>CO<sub>2</sub> / O<sub>2</sub> control is deactivated and will only be activated after confirming the information message “Successful sterilization” and when the temperature has cooled down to a value below &lt; 80 °C.</p>
---	---

## 22. Maintenance and service, troubleshooting, repair, testing

### 22.1 General information, personnel qualification

- **Maintenance**

See chap. 22.5.

- **Simple troubleshooting**

Chap. 22.6 describes troubleshooting by operating personnel. It does not require technical intervention into the chamber, nor disassembly of chamber parts.

For personnel requirements please refer to chap. 1.1.

- **Detailed troubleshooting**

If errors cannot be identified with simple troubleshooting, further troubleshooting must be performed by BINDER Service or by BINDER qualified service partners or technicians, in accordance with the description in the Service Manual.

For personnel requirements please refer to the Service Manual.

- **Repair**

Repair of the chamber can be performed by BINDER Service or by BINDER qualified service partners or technicians, in accordance with the description in the Service Manual.

After maintenance, the chamber must be tested prior to resuming operation.

- **Electrical testing**

To prevent the risk of electrical shock from the electrical equipment of the chamber, an annual repeat inspection as well as a test prior to initial startup and prior to resuming operation after maintenance or repair, are required. This test must meet the requirements of the competent public authorities. We recommend testing under EN 50678/VDE 0701 and EN 50699/VDE 0702 in accordance with the details in the Service Manual.

For personnel requirements please refer to the Service Manual.

## 22.2 CBF / CBF-UL: Replacing components of the humidifying / dehumidifying system

### 22.2.1 Replacing the silicone tube of the fresh water supply system

The silicone tube (DN 3mm) (art. no. 6008-0267) is included with the following humidifying sets:

- Tubular bag set with 3 tubular bags (Art. No. 8009-1083, included): 6 m (chap. 4.5.2)
- Tubular bag set with 12 tubular bags (Art. No. 8009-1058, option): 6 m (chap. 4.5.2)
- Humidification water set (Art. No. 8009-1104, option): 2 m (chap. 4.5.3)
- Water container set (Art. No. 8009-1128, option): 10 m (chap. 4.5.4)

It is also available by the meter from BINDER.

To operate the freshwater supply via tubular bags (standard), a total length of 32 cm is required.

To replace the DN 3mm silicone tube, proceed as described in chap. 4.5.

### 22.2.2 Replacing the pump head of the fresh water supply system

A pump head for the tube pump for freshwater supply is available under art.no. 5013-0204. To replace the pump head, proceed as described in chap. 4.5.

### 22.2.3 Replacing the gas fine filter (sterile filter) for ambient air

The air tube for inlet of the ambient air is located in the upper right corner in the recess for the freshwater bag. We recommend replacing the gas fine filter (sterile filter) on this tube about once a month. To do this, hold the sterile filter and pull out a bit the air tube connected to it. Unscrew the filter and screw on a new filter. Then push the tube back in.



Figure 52: Location of the gas fine filter (sterile filter) in the recess for the freshwater bag





## 22.3 Replacing the CO<sub>2</sub> und O<sub>2</sub>/N<sub>2</sub> gas inlet fine filters (sterile filters)

When the chamber is in operation, the incoming gas passes through a fine gas filter (aseptic filter, filtration efficiency 99.99 %, particle size 0.45 µm). This fine filter prevents dirt accumulating in the gas inlet valves and the tubes leading into the inner chamber, which could be in the gas cylinder or in the supply tubes.

When using gas with a technical grade of 99.5 %, we recommend changing the fine gas filter once a year. Please consult BINDER Service. When using gases with less pureness, the changing intervals should be shorter.

- Pull the power plug.

	 <b>CAUTION</b>
<p><b>Risk of injuries by sharp edges on the rear panel.</b>  <b>Cuts.</b>          ➤ Wear protective gloves when removing or installing the cover on the chamber rear</p>	

Remove the cover on the chamber rear

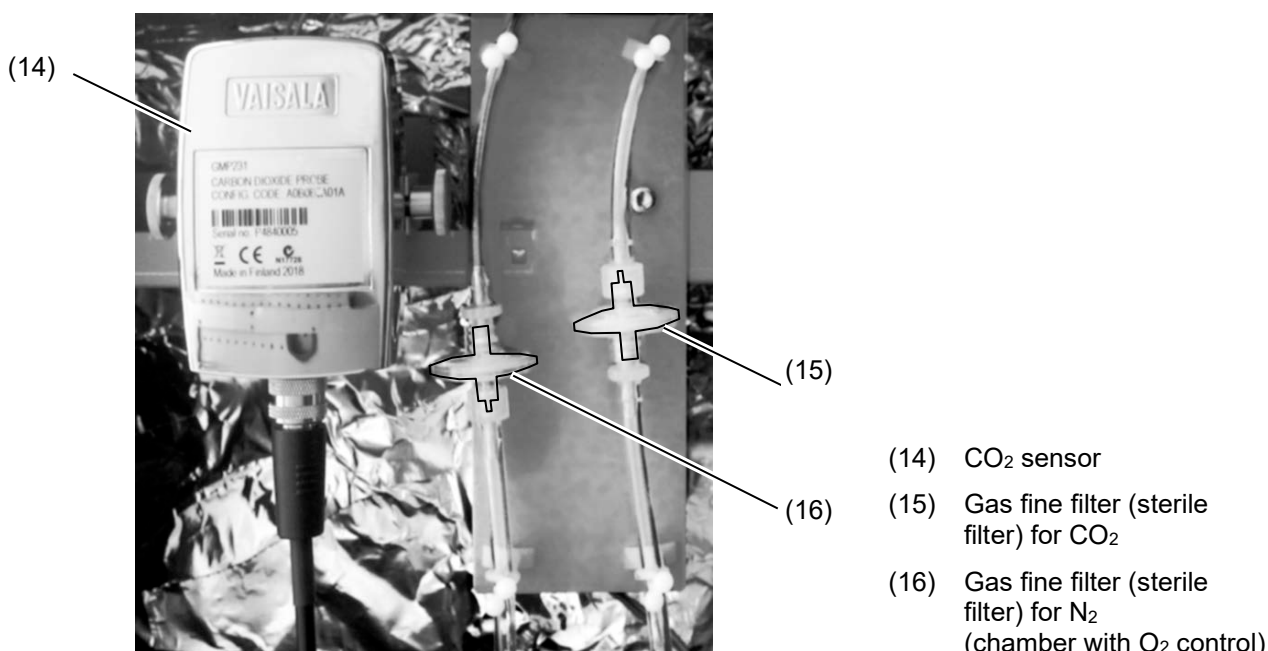
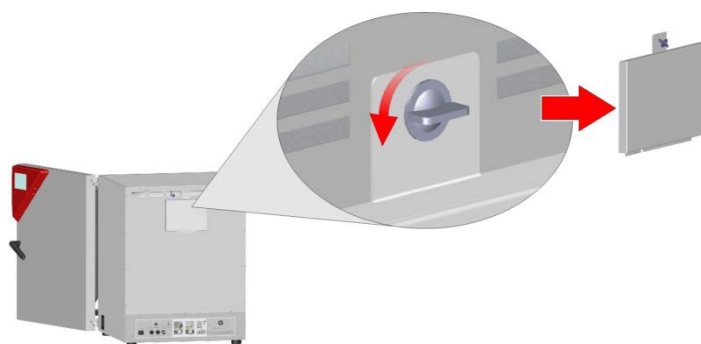



Figure 53: Position of the CO<sub>2</sub> sensor and the gas fine filters behind the cover

- Unscrew the desired gas fine filter on both sides from the gas tubes and then screw on a new filter.
- Reinstall the cover on the chamber rear.

## 22.4 Replacing the CO<sub>2</sub> sensor

- Pull the power plug.

	 <b>CAUTION</b>
<p><b>Risk of injuries by sharp edges on the rear panel.</b>  <b>Cuts.</b>          ➤ Wear protective gloves when removing or installing the cover on the chamber rear</p>	

- Remove the cover on the chamber rear

The position of the CO<sub>2</sub> sensor behind the cover is shown in Figure 53.

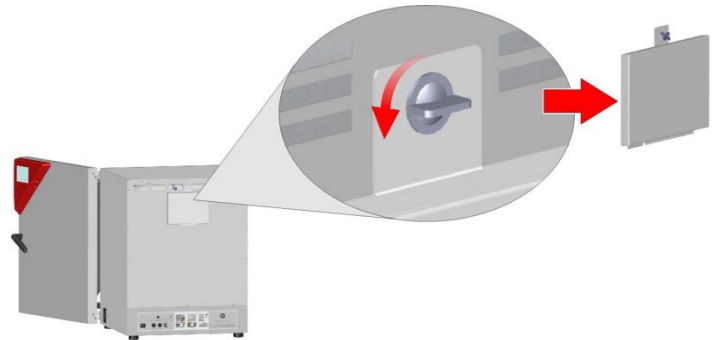

- Unscrew the cable from the sensor.

Make sure that the sensor cable does not fall into the inner chamber.

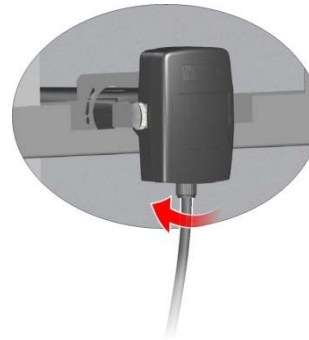

- Remove the fixing screws on both sides of the sensor.

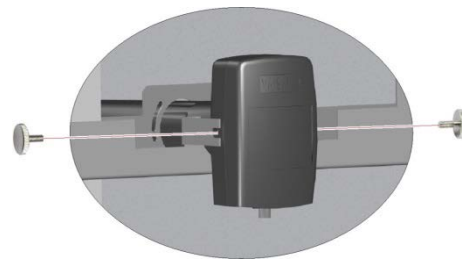

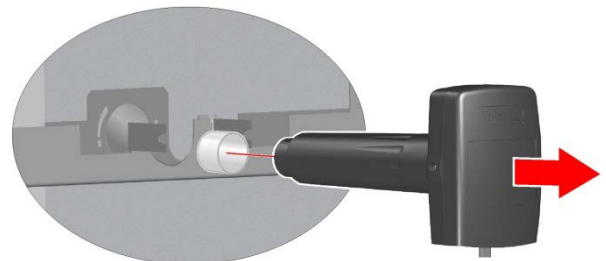

- Pull the sensor backwards out of the holder. The filter (white) attached to the sensor is pulled out together with the sensor.



- Then mount the new sensor proceeding in reverse order
- Reinstall the cover on the chamber rear.

	<p>The sensor may only be used with the attached filter.          After replacing the CO<sub>2</sub> sensor repeat the CO<sub>2</sub> calibration.</p>
---	--

## 22.5 Maintenance intervals, service

 	 <b>DANGER</b>
	<p><b>Electrical hazard during live maintenance work.</b>  <b>Deadly electric shock.</b></p> <ul style="list-style-type: none"> <li>∅ The chamber must NOT become wet during operation or maintenance works.</li> <li>∅ Do NOT remove the rear panel of the chamber.</li> <li>➤ Before conducting maintenance work, turn off the chamber at the main power switch and disconnect the power plug.</li> <li>➤ Make sure that any maintenance work will be conducted by licensed electricians or experts authorized by BINDER.</li> </ul>

Ensure regular maintenance work is performed at least once a year and that the legal requirements are met regarding the qualifications of service personnel, scope of testing and documentation.

	The warranty becomes void if maintenance work is conducted by non-authorized personnel.
---	---

**CBF / CBF-UL:** Have conducted regular maintenance work on the steam humidifier at least once a year. The operating behavior and the maintenance intervals of the humidifier essentially depend on the available water quality and the amount of steam produced in the meantime.

	Replace the door gasket only when cold. Otherwise, the door gasket may become damaged.
--	--

We recommend taking out a maintenance agreement. Please consult BINDER Service.

BINDER telephone hotline:	+49 (0) 7462 2005 555
BINDER fax hotline:	+49 (0) 7462 2005 93555
BINDER service hotline USA:	+1 866 885 9794 or +1 631 224 4340 x3 (toll-free in the USA)
BINDER service hotline Asia Pacific:	+852 390 705 04 or +852 390 705 03
BINDER Internet website	<a href="http://www.binder-world.com">http://www.binder-world.com</a>
BINDER address	BINDER GmbH, post office box 102, 78502 Tuttlingen, Germany

International customers, please contact your local BINDER distributor.

	The gas sensors are especially adjusted for the individual incubator. When exchanging a sensor, you must repeat control adjustment for CO <sub>2</sub> and O <sub>2</sub> (chamber with O <sub>2</sub> control).
---	--

After 8760 operating hours or two years the following message appears:

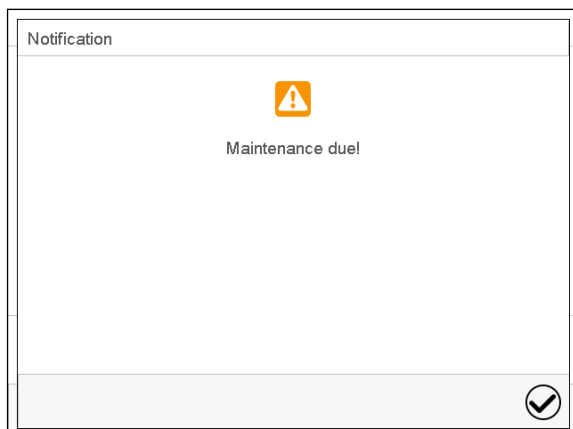

After confirmation with the **Confirm** icon, the message window will pop up again every two weeks until it is reset by BINDER Service.

## 22.6 Simple troubleshooting

Defects and shortcomings can compromise the operational safety of the chamber and can lead to risks and damage to equipment and persons. If there are is a technical fault or shortcoming, take the chamber out of operation and inform BINDER Service. If you are not sure whether there is a technical fault, proceed according to the following list. If you cannot clearly identify an error or there is a technical fault, please contact BINDER Service.



Only qualified service personnel authorized by BINDER must perform repair.  
Repaired chambers must comply with the BINDER quality standards.

### 22.6.1 General

Fault description	Possible cause	Required measures
Chamber without function.	No power supply.	Check connection to power supply. Check whether the chamber is turned on at the main power switch.
	Wrong voltage.	Check power supply for voltage of 100-120V or 200-240V.
	Chamber fuse has responded.	Check chamber fuse and replace it if appropriate. If it responds again, contact BINDER service.
	Controller defective.	Contact BINDER service.
	Nominal temperature exceeded by 10 °C due to chamber failure. Over temperature protective device (class 1) responds.	

## 22.6.2 Heating

Fault description	Possible cause	Required measures
<b>Excess temperature.</b> Having reached the setpoint, the temperature exceeds the setpoint by more than the set tolerance range value (more than 10 min.) Alarm message "Temp. range"	Site of installation too warm. Difference between the set temperature and the ambient temperature too low.	Acknowledge the alarm on the controller. Observe the difference between the set temperature and the ambient temperature, see technical data chap. 24.4.
	Controller defective.	Acknowledge the alarm on the controller. Contact BINDER service.
	Semiconductor relay defective	
<b>Excess temperature.</b> Overtemperature safety controller class 3.1 responds. Alarm message "Safety controller"	Temperature controller not adjusted.	Acknowledge the alarm on the controller. Calibrate and adjust the temperature controller.
	Safety controller setpoint value exceeded.	Acknowledge the alarm on the controller. Check setting of temperature setpoint and of the safety controller class 3.1 setpoint. If appropriate, select suitable value.
	Too much external heat load.	Acknowledge the alarm on the controller. Reduce heat load.
	Controller defective. Semiconductor relay defective Safety controller defective.	Acknowledge the alarm on the controller. Contact BINDER service.
<b>Too low temperature.</b> Having reached the setpoint, the temperature falls below the setpoint by more than the set tolerance range value (more than 10 min.) <b>or</b> the temperature doesn't reach the tolerance range within 3 hours from turning on the chamber or closing the door. Alarm message "Temp. range"	Chamber door not properly closed.	Acknowledge the alarm on the controller. Completely close chamber door.
	Door gaskets defective.	Acknowledge the alarm on the controller. Replace door gasket.
	Controller defective.	Acknowledge the alarm on the controller. Check the function of the temperature controller.
	Door gasket defective.	Replace door gasket.
	Temperature controller not adjusted.	Calibrate and adjust the temperature controller.
Chamber doesn't heat up. Alarm message "Safety controller"	Inner chamber temperature has reached the safety controller setpoint. Safety controller set too low.	Acknowledge the alarm on the controller. Check temperature setpoint setting. If appropriate, select suitable safety controller setpoint (chap. 12.2).
	Safety controller defective.	Acknowledge the alarm on the controller. Contact BINDER service.
Chamber doesn't heat up.	Pt 100 sensor defective.	Contact BINDER service.
	Heating element defective.	
	Semiconductor relay defective.	
	Controller defective.	

Fault description	Possible cause	Required measures
Very long heating-up times.	Chamber fully loaded.	Load the chamber less or consider longer heating-up times.
The displayed actual temperature value deviates largely compared with a reference method..	Temperature control not adjusted.	Calibrate and adjust the temperature control.
	Temperature sensor defective.	Transfer the cultures to another incubator and contact BINDER Service.

### 22.6.3 Gas cylinder pressure too low

The alarm messages indicate that the pressure in the supply lines of CO<sub>2</sub>, O<sub>2</sub> (chamber with O<sub>2</sub> control) and N<sub>2</sub> (chamber with O<sub>2</sub> control) has dropped below 0.3 bar. If no gas cylinder changer is installed, the gas cylinder must be replaced. Observe the safety instructions and the maximum outlet pressure (chap. 4.4).



Prerequisite for pressure alarm messages for O<sub>2</sub> and N<sub>2</sub> (chamber with O<sub>2</sub> control) is that the O<sub>2</sub> / N<sub>2</sub> control with the respective alarms are activated (chap. 6.7, 7.3).

**Note:** The recovery times of the gas concentrations inside the chamber following door opening, which are indicated in the technical data (chap. 24.4), refer to a connection pressure of 2.0 bar / 29 *psi*. Decreasing supply pressure down to the shift point (alarm point) of 0.3 bar / 4.4 *psi* results in longer recovery times. Check the pressure displays of your gas supply. If very short recovery times are required or the door is opened frequently, replace the gas cylinders promptly when the pressure decreases below 2.0 bar / 29 *psi*.

Fault description	Possible cause	Required measures
Low CO <sub>2</sub> outlet pressure (< 0.3 bar) Alarm message "CO2 pressure"	CO <sub>2</sub> cylinder is not connected correctly.	Acknowledge the alarm on the controller. Correctly connect the gas cylinder.
	Connected gas cylinder is closed.	Acknowledge the alarm on the controller. Open the gas cylinder.
	Connected gas cylinder is empty.	Acknowledge the alarm on the controller. Replace the gas cylinder. Observe the safety instructions and the maximum outlet pressure (chap. 4.4).
	Gas hose is dirty or obstructed.	Acknowledge the alarm on the controller. Turn off the gas supply and remove the gas connections. Check the tube system for dirt accumulation or obstruction, clean or replace it.
	Controller malfunction.	Acknowledge the alarm on the controller. If necessary, contact BINDER Service.
	Pressure sensor system defective.	Acknowledge the alarm on the controller. Contact BINDER Service.

Fault description	Possible cause	Required measures
<b>Chamber with O<sub>2</sub> control:</b> Low O <sub>2</sub> outlet pressure (< 0.3 bar). Alarm message "O <sub>2</sub> pressure"	O <sub>2</sub> cylinder is not connected correctly.	Acknowledge the alarm on the controller. Correctly connect the gas cylinder.
	Connected gas cylinder is closed.	Acknowledge the alarm on the controller. Open the gas cylinder.
	Connected gas cylinder is empty.	Acknowledge the alarm on the controller. Replace the gas cylinder. Observe the safety instructions and the maximum outlet pressure (chap. 4.4).
	Gas hose is dirty or obstructed.	Acknowledge the alarm on the controller. Turn off the gas supply and remove the gas connections. Check the tube system for dirt accumulation or obstruction, clean or replace it.
	Controller malfunction	Acknowledge the alarm on the controller. If necessary, contact BINDER Service.
	Pressure sensor system defective.	Acknowledge the alarm on the controller. Contact BINDER Service.
<b>Chamber with O<sub>2</sub> control:</b> Low N <sub>2</sub> outlet pressure (< 0.3 bar). Alarm message "N <sub>2</sub> pressure"	N <sub>2</sub> cylinder is not connected correctly.	Acknowledge the alarm on the controller. Correctly connect the gas cylinder.
	Connected gas cylinder is closed.	Acknowledge the alarm on the controller. Open the gas cylinder.
	Connected gas cylinder is empty.	Acknowledge the alarm on the controller. Replace the gas cylinder. Observe the safety instructions and the maximum outlet pressure (chap. 4.4).
	Gas hose is dirty or obstructed.	Acknowledge the alarm on the controller. Turn off the gas supply and remove the gas connections. Check the tube system for dirt accumulation or obstruction, clean or replace it.
	Controller malfunction	Acknowledge the alarm on the controller. If necessary, contact BINDER Service.
	Pressure sensor system defective.	Acknowledge the alarm on the controller. Contact BINDER Service.

#### 22.6.4 Gas control

Fault description	Possible cause	Required measures
<b>Excess CO<sub>2</sub> concentration.</b> Having reached the setpoint, CO <sub>2</sub> exceeds the setpoint by more than the set tolerance range value (more than 10 min.) Alarm message "CO <sub>2</sub> range"	Temporary disturbance of the CO <sub>2</sub> control.	Acknowledge the alarm on the controller. Turn off the chamber. Open the chamber doors for approx. 5 minutes. Observe the general information for safe handling of CO <sub>2</sub> (chap. 1.9). Turn on the chamber again. Upon renewed alarm, contact BINDER service.
	CO <sub>2</sub> sensor defective.	Acknowledge the alarm on the controller. Contact BINDER Service. To replace the sensor proceed as described in chap. 22.4.

Fault description	Possible cause	Required measures
<p><i>Chamber with O<sub>2</sub> control:</i>  <b>Excess O<sub>2</sub> concentration.</b>            Having reached the setpoint, O<sub>2</sub> exceeds the setpoint by more than the set tolerance range value (more than 10 min.) (O<sub>2</sub> control option)            Alarm message "O<sub>2</sub> range"</p>	Temporary disturbance of the O <sub>2</sub> control.	Acknowledge the alarm on the controller. Turn off the chamber. Open the chamber doors for approx. 5 minutes. Observe the general information for safe handling of oxygen (chap. 1.9).. Prevent oxygen enrichment in the ambience of the chamber. Turn on the chamber again. Upon renewed alarm, contact BINDER service.
	O <sub>2</sub> sensor defective.	Acknowledge the alarm on the controller. Contact BINDER Service.
Recovery time (up to 5 vol.-% CO <sub>2</sub> ) after doors were open for 2 minutes is < 2 minutes	CO <sub>2</sub> sensor system defective.	Contact BINDER Service.
<p><b>Too low CO<sub>2</sub> concentration.</b>            Having reached the setpoint, CO<sub>2</sub> falls below the setpoint by more than the set tolerance range value (more than 10 min.) <b>or</b> CO<sub>2</sub> doesn't reach the tolerance range within 3 hours from turning on the chamber or closing the door.            Alarm message "CO<sub>2</sub> range"</p>	Temporary disturbance of the CO <sub>2</sub> control.	Acknowledge the alarm on the controller. Turn off the chamber. After approx. 5 minutes turn on the chamber again. Upon renewed alarm, contact BINDER service.
	CO <sub>2</sub> sensor defective.	Acknowledge the alarm on the controller. Contact BINDER Service. To replace the sensor proceed as described in chap. 22.4.
<p><i>Chamber with O<sub>2</sub> control:</i>  <b>Too low O<sub>2</sub> concentration.</b>            Having reached the setpoint, O<sub>2</sub> falls below the setpoint by more than the set tolerance range value (more than 10 min.) <b>or</b> O<sub>2</sub> doesn't reach the tolerance range within 3 hours from turning on the chamber or closing the door.            Alarm message "O<sub>2</sub> range".</p>	Temporary disturbance of the O <sub>2</sub> control.	Acknowledge the alarm on the controller. Turn off the chamber. After approx. 5 minutes turn on the chamber again. Upon renewed alarm, contact BINDER service.
	O <sub>2</sub> sensor defective.	Acknowledge the alarm on the controller. Contact BINDER Service.
<p><b>Too low gas concentration.</b>            The concentration of CO<sub>2</sub> or O<sub>2</sub> (chamber with O<sub>2</sub> control) does not reach the adjusted set value.</p>	Door gaskets defective.	Replace door gaskets
	Doors not closed properly.	Close door properly.
	Connected gas cylinder is empty or not opened.	Open or replace gas cylinder.
	Gas cylinder is not connected correctly.	Correctly connect the gas cylinder.
	Gas hose is dirty or obstructed.	Check the tube system for dirt accumulation or obstruction, clean or replace it.
Recovery time (up to 5 vol.-% CO <sub>2</sub> ) after doors were open for 2 minutes is > 10 minutes.	Obstructed gas supply.	Check gas supply (cylinder, connections, hose system).
	Insufficient CO <sub>2</sub> input pressure	
Unusually high gas consumption.	Door gaskets defective.	Replace door gaskets
	Gas sensor not adjusted.	Calibrate the sensor.
	Gas sensor defective.	Contact BINDER Service
	Gas fine filter not connected correctly.	



Fault description	Possible cause	Required measures
The displayed actual value of CO <sub>2</sub> deviates largely compared with a reference method.. The pH indicator of the cell culture medium changes its normal color.	CO <sub>2</sub> control not adjusted.	Calibrate and adjust CO <sub>2</sub> control.
	CO <sub>2</sub> sensor defective.	Transfer the cultures to another incubator and contact BINDER Service. To replace the sensor proceed as described in chap. 22.4.
<i>Chamber with O<sub>2</sub> control:</i> The displayed actual value of O <sub>2</sub> (option) deviates largely compared with a reference method.	O <sub>2</sub> control not adjusted.	Calibrate and adjust O <sub>2</sub> control.
	O <sub>2</sub> sensor defective.	Transfer the cultures to another incubator and contact BINDER Service.
No gas control after hot-air sterilization.	Sterilization cycle still running.	Terminate hot-air sterilization.
	Information message not confirmed.	Confirm the information message with "Ok".
	Inner chamber temperature above 80 °C	Let the inner chamber temperature decrease below 80 °C.
Condensation on the glass door and on the CO <sub>2</sub> sensor head under the filter cap. Alarm message: "CO <sub>2</sub> sensor not ready". After 6 hours with no user reaction, this message is replaced by the alarm message: "CO <sub>2</sub> sensor fault".	Outer door open and inner glass door closed for more than 5 minutes	Acknowledge the alarm on the controller. Remove the filter cap and let it dry until there is no visible condensation. Plug on the filter cap. <i>If after drying the alarm message reappears</i> , contact BINDER Service.
	Power failure for more than 5 minutes	
	CO <sub>2</sub> sensor defective	Acknowledge the alarm on the controller. Contact BINDER Service. To replace the sensor proceed as described in chap. 22.4.

### 22.6.5 Sterilization

Indication	Possible cause	Required measures
The sterilization is running. Alarm message "Sterilization".	Sterilization cycle is running	Acknowledge the alarm on the controller. Do not open the door.

### 22.6.6 Humidity (CB / CB-UL)

Fault description	Possible cause	Required measures
Condensations inside the chamber.	Permadry™ pan filled with water when the chamber is not operating.	Empty Permadry™ pan when the chamber is not operating.
	Door gaskets defective.	Replace door gaskets
	Doors not closed properly.	Close door properly.
	Humidity set too high.	Reduce humidity (chap. 6.8)
Condensation on the doors or on the optional divided inner door.	Chamber placed on very cold floor.	Place the chamber on a BINDER stand to increase the distance to the floor.
	Door gaskets defective.	Replace door gaskets
	Doors not closed properly.	Close door properly.
	Humidity set too high.	Reduce humidity (chap. 6.8)
	Door heating set too low.	Contact BINDER Service to adjust the door heating

Fault description	Possible cause	Required measures
Too low humidity inside.	Humidity set too low.	Increase humidity (chap. 6.8)
	Chamber door not properly closed.	Completely close chamber door.
	Door gasket defective.	Replace door gasket.
	Permadyr™ pan empty.	Fill the outer Permadyr™ pan with water up to the marking on the inner pan with distilled, sterile water. The pan must have thorough contact to the bottom of the inner chamber, see chap. 4.2.

### 22.6.7 Humidity (CBF / CBF-UL)

Fault description	Possible cause	Required measures
Humidity fluctuation: Control accuracy of +/- 3 % r.h. is not reached.	Door gasket defective.	Replace door gasket.
	Door opened very frequently.	Open doors less frequently.
Humidity fluctuation, together with temperature fluctuation > 1 °C with a set-point approx. 3 °C above ambient temperature.	Place of installation too hot.	Select cooler place of installation or contact BINDER service.
Alarm message "Humidity system".	Humidity module defective.	Acknowledge the alarm on the controller. Contact BINDER service.
Alarm message "Freshwater supply".	Freshwater bag is empty or contains air.	Acknowledge the alarm on the controller. Fill the freshwater bag correctly.
	The silicon tube is not correctly inserted into the pump.	Acknowledge the alarm on the controller.
	Silicon tube kinked.	Place the silicon tube correctly (chap. 4.5.2).
Too high humidity inside the chamber (exceeding the set-point)	Ambient humidity too high at site of installation	Possible dehumidification depends on ambient humidity. Select installation site with lower humidity.

### 22.6.8 Controller

Fault description	Possible cause	Required measures
No chamber function (dark display).	Display in standby mode.	Press on touchscreen.
	Main power switch turned off.	Turn on the main power switch.
Menu functions not available.	Menu functions not available with current authorization level.	Log in with the required higher authorization. or contact BINDER service to obtain an activation code (chap. 13.6).
No access to controller	Password incorrect.	Contact BINDER service.
Chart recorder function: measured-value memory cleared; information lost.	New setting of storage rate or scaling (minimum and/or maximum) (chap. 16.2).	Change the storage rate or scaling ONLY if the previously registered data are no longer required.

Fault description	Possible cause	Required measures
Controller does not equilibrate to setpoints entered in Fixed value operation mode	Controller is not in Fixed value operation mode.	Change to Fixed value operation mode.
	CO <sub>2</sub> control is deactivated.	Activate CO <sub>2</sub> control (chap. 6.7).
	<i>Chamber with O<sub>2</sub> control:</i> O <sub>2</sub> control is deactivated.	Activate O <sub>2</sub> control (chap. 6.7).
	CBF / CBF-UL: Humidity control is deactivated.	Activate humidity control (chap. 6.7).
Controller does not equilibrate to program set-points.	Controller is not in program operation mode, or program delay time is running.	Start the program again. If appropriate, wait for the program delay time.
Program duration longer than programmed.	Tolerances have been programmed.	For rapid transition phases, do NOT program tolerance limits in order to permit maximum speed for heating, gas control or humidification.
Program keeps the last program setpoint constant while in setting "ramp".	Program line with setting "ramp" is incomplete.	When programming with setting "ramp", define the end value of the desired cycle by adding an additional section with a section time of at least one second.
Ramp temperature transitions are only realized as steps.	Setting "step" has been selected.	Select setting "ramp".
CBF / CBF-UL: Humidity alarm when operating without water supply.	Humidity control is activated.	Deactivate humidity control (chap. 6.7).
Acknowledging the alarm does not cancel the alarm state.	Cause of alarm persists.	Remove cause of alarm. If the alarm state continues, contact BINDER service.
Alarm message: - - - - or <-<-< or >->->	Sensor rupture between sensor and controller or Pt 100 sensor defective.	Contact BINDER service.

### 22.6.9 Open door

Indication	Possible cause	Required measures
Outer door open (longer than the selected alarm delay time) Alarm message "Door open".	Outer door open or not properly closed.	Acknowledge the alarm on the controller. Close the door. The triggered zero-voltage relay alarm contact switches back.

## 22.7 Sending the chamber back to BINDER GmbH

If you return a BINDER product to us for repair or any other reason, we will only accept the product upon presentation of an **authorization number** (RMA number) that has previously been issued to you. An authorization number will be issued after receiving your complaint either in writing or by telephone **prior** to your sending the BINDER product back to us. The authorization number will be issued following receipt of the information below:

- BINDER product type and serial number
- Date of purchase
- Name and address of the dealer from which you bought the BINDER product
- Exact description of the defect or fault
- Complete address, contact person and availability of that person
- Exact location of the BINDER product in your facility
- A contamination clearance certificate (chap. 26) must be faxed in advance

The authorization number must be applied to the packaging in such a way that it can be easily recognized or be recorded clearly in the delivery documents.



For security reasons we cannot accept a chamber delivery if it does not carry an authorization number.

**Return address:** BINDER GmbH Gänsäcker 16  
Abteilung Service 78502 Tuttlingen, Germany

## 23. Disposal

### 23.1 Disposal of the transport packing

#### 23.1.1 Outer chamber packing

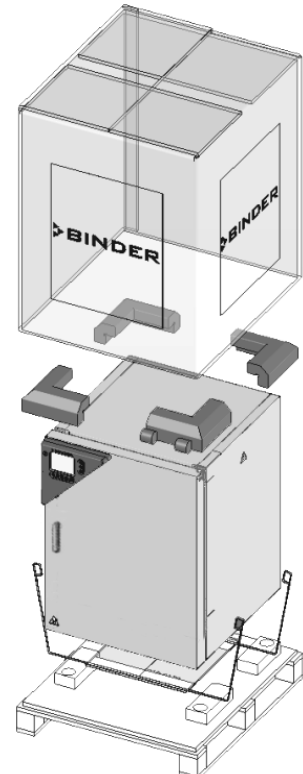
Packing element	Material	Disposal	
	Straps to fix packing on pallet (no image)	Plastic recycling	
	Shipping box	Paper recycling	
	Edge stuffing, top	Plastic recycling	
	Pallet with foamed plastic stuffing	PE foam	Plastic recycling
		Solid wood (IPPC standard)	Wood recycling

#### 23.1.2 Packing inside the chamber and equipment

Packing element	Material	Disposal
Door protection	PE foam	Plastic recycling
Packing box equipment	Cardboard	Paper recycling
Insulating air cushion foil	PE foil	Plastic recycling
Bag for operating manuals	PE foil	Plastic recycling



If recycling is not possible, all packing parts can also be disposed of with normal waste.

## 23.2 Decommissioning

- Turn off the chamber at the main power switch and disconnect it from the power supply (pull the power plug).



When switching off the main power switch, the stored parameters remain saved.

- Turn off the CO<sub>2</sub> supply and the O<sub>2</sub> / N<sub>2</sub> supplies (chamber with O<sub>2</sub> control). Remove the gas connections.
- CBF / CBF-UL: Empty the freshwater bag.
- Let the inner chamber sufficiently cool down after a hot-air sterilization before removing any parts.
- CB/CB-UL: The Permadyr™ water pan must not remain filled while the chamber is out of operation. Otherwise condensation on the inner surfaces and the CO<sub>2</sub> sensor head may occur. In this case, clean and dry the chamber with doors open for at least one hour before restarting the chamber. BINDER recommends performing a hot air sterilization of the chamber before commissioning.
- Temporal decommissioning: See indications for appropriate storage, chap. 3.3.
- Final decommissioning: Dispose of the chamber as described in chap. 23.3 to 23.5.
- When restarting the chamber, please pay attention to the corresponding safety information.

## 23.3 Disposal of the chamber in the Federal Republic of Germany

According to Annex I of Directive 2012/19/EU of the European Parliament and of the Council on waste electrical and electronic equipment (WEEE), BINDER devices are classified as “monitoring and control instruments” (category 9) only intended for professional use“. They must not be disposed of at public collecting points.

The chambers bear the symbol for the marking of electrical and electronic equipment manufactured / placed on the market in the EU after 13 August 2005 and be disposed of in separate collection according to Directive 2012/19/EU on waste electrical and electronic equipment (WEEE) and German national law for electrical and electronic equipment (Elektro- und Elektronikgerätegesetz, ElektroG). WEEE marking: crossed-out wheeled bin. A significant part of the materials must be recycled in order to protect the environment.

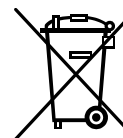

At the end of the device's service life, have the chamber disposed of according to the German national law for electrical and electronic equipment (Elektro- und Elektronikgerätegesetz, ElektroG from 20 October 2015, BGBl. I p. 1739) or contact BINDER service who will organize taking back and disposal of the chamber according to the German national law for electrical and electronic equipment (Elektro- und Elektronikgerätegesetz, ElektroG from 20 October 2015, BGBl. I p. 1739).



### NOTICE



**Danger of violation against existing law if not disposed of properly.**

**Failure to comply with applicable law.**

- ⊘ Do NOT dispose of BINDER devices at public collecting points.
- Have the device disposed of professionally at a recycling company which is certified according to the German national law for electrical and electronic equipment (Elektro- und Elektronikgerätegesetz, ElektroG from 20 October 2015, BGBl. I p. 1739).
- or
- Instruct BINDER Service to dispose of the device. The general terms of payment and delivery of BINDER GmbH apply, which were valid at the time of purchasing the chamber.

Certified companies disassemble waste (used) BINDER equipment in primary substances for recycling according to Directive 2012/19/EU. The devices must be free from toxic, infectious or radioactive substances in order to eliminate any health hazards to the employees of the recycling companies.

	<ul style="list-style-type: none"> <li>• Prior to handing the chamber over to a recycling company, it is the user's responsibility that it is free from toxic, infectious or radioactive substances.</li> <li>• Prior to disposal, clean all introduced or residual toxic substances from the chamber.</li> <li>• Prior to disposal, disinfect the chamber from all sources of infection. Be aware that sources of infection may also be located outside the inner chamber.</li> <li>• If you cannot safely remove all toxic substances and sources of infection from the chamber, dispose of it as special waste according to national law.</li> <li>• Fill out the contamination clearance certificate (chap. 26) and enclose it with the chamber.</li> </ul>
---	---

	 <b>WARNING</b>
	<p><b>Danger of intoxication and infection through contamination of the chamber with toxic, infectious or radioactive substances.</b></p> <p><b>Damages to health.</b></p> <ul style="list-style-type: none"> <li>Ø NEVER take a chamber contaminated with toxic substances or sources of infection for recycling according to Directive 2012/19/EU.</li> <li>➤ Prior to disposal, remove all toxic substances and sources of infection from the chamber.</li> <li>➤ A chamber from which all toxic substances or sources of infection cannot be safely removed must be considered as "special" waste according to national law. Dispose of it accordingly.</li> </ul>

The main board of the chamber includes a lithium cell. As the end user, you are legally obliged to return used batteries. Old batteries and rechargeable batteries must not be disposed of with household waste. They can be handed in free of charge at the community's public collection points and wherever batteries and accumulators of the type in question are sold.

### 23.4 Disposal of the chamber in the member states of the EU except for the Federal Republic of Germany

According to Annex I of Directive 2012/19/EU of the European Parliament and of the Council on waste electrical and electronic equipment (WEEE), BINDER devices are classified as "monitoring and control instruments" (category 9) only intended for professional use". They must not be disposed of at public collecting points.

The chambers bear the symbol for the marking of electrical and electronic equipment manufactured / placed on the market in the EC after 13 August 2005 and be disposed of in separate collection according to the Directive 2012/19/EU on waste electrical and electronic equipment (WEEE). WEEE marking: crossed-out wheeled bin.

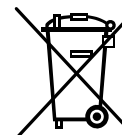



At the end of the device's service life, notify the distributor who sold you the device, who will take back and dispose of the chamber according to the Directive 2012/19/EU on waste electrical and electronic equipment (WEEE).

	NOTICE
	<p><b>Danger of violation against existing law if not disposed of properly.</b></p> <p><b>Failure to comply with applicable law.</b></p> <ul style="list-style-type: none"> <li>⊘ Do NOT dispose of BINDER devices at public collecting points.</li> <li>➤ Have the device disposed of professionally at a recycling company that is certified according to conversion of the Directive 2012/19/EU into national law.</li> <li style="padding-left: 20px;"><i>or</i></li> <li>➤ Instruct the distributor who sold you the device to dispose of it. The agreements apply that were agreed with the distributor when purchasing the chamber (e.g. his general terms of payment and delivery).</li> <li>➤ If your distributor is not able to take back and dispose of the chamber, please contact BINDER service.</li> </ul>



Certified companies disassemble waste (used) BINDER equipment in primary substances for recycling according to Directive 2012/19/EU. The devices must be free from toxic, infectious or radioactive substances in order to eliminate any health hazards to the employees of the recycling companies.

	<ul style="list-style-type: none"> <li>• Prior to handing the chamber over to a recycling company, it is the user's responsibility that it is free from toxic, infectious or radioactive substances.</li> <li>• Prior to disposal, clean all introduced or residual toxic substances from the chamber.</li> <li>• Prior to disposal, disinfect the chamber from all sources of infection. Be aware that sources of infection may also be located outside the inner chamber.</li> <li>• If you cannot safely remove all sources of infection and toxic substances from the chamber, dispose of it as special waste according to national law.</li> <li>• Fill out the contamination clearance certificate (chap. 26) and enclose it with the chamber.</li> </ul>
---	---

 	 <b>WARNING</b>
	<p><b>Danger of intoxication and infection through contamination of the chamber with toxic, infectious or radioactive substances.</b></p> <p><b>Damages to health.</b></p> <ul style="list-style-type: none"> <li>⊘ NEVER take a chamber contaminated with toxic substances or sources of infection for recycling according to Directive 2012/19/EU.</li> <li>➤ Prior to disposal, remove all toxic substances and sources of infection from the chamber.</li> <li>➤ A chamber from which all toxic substances or sources of infection cannot be safely removed must be considered as "special" waste according to national law. Dispose of it accordingly.</li> </ul>

The main board of the chamber includes a lithium cell. The disposal of batteries within the EU must be carried out in accordance with the current EU directives as well as national, regional and local environmental protection regulations.

## 23.5 Disposal of the chamber in non-member states of the EU

 	<p style="text-align: center;"><b>NOTICE</b></p> <p><b>Danger of violation against existing law if not disposed of properly.</b>  <b>Failure to comply with applicable law. Alteration of the environment.</b></p> <ul style="list-style-type: none"> <li>➤ For final decommissioning and disposal of the chamber, please contact BINDER service.</li> <li>➤ Follow the statutory regulations for appropriate, environmentally friendly disposal.</li> </ul>
--	--

The main board of the chamber includes a lithium cell. Used batteries must be disposed of properly. Please ensure that you dispose of the battery in accordance with the regulations in force in your country.

## 24. Technical description

### 24.1 Factory calibration and adjustment

This chamber was calibrated and adjusted in the factory. Calibration and adjustment were performed using standardized test instructions, according to the QM DIN EN ISO 9001 system applied by BINDER (certified since December 1996 by TÜV CERT). All test equipment used is subject to the administration of measurement and test equipment that is also a constituent part of the BINDER QM DIN EN ISO 9001 systems. They are controlled and calibrated to a DKD-Standard at regular intervals.

A record of this calibration and adjustment is part of the BINDER test certificate of the chamber.

#### Adjustment in factory:

- **Temperature:** 37 °C / 98.6°F measured in the center of the usable volume
- **CO<sub>2</sub>:** 0 vol.-% CO<sub>2</sub> (100 vol.-% N<sub>2</sub>) and 5 vol.-% CO<sub>2</sub> (analyzed test gas directly exposed to the sensor head)
- **O<sub>2</sub>** (chamber with O<sub>2</sub> control): 0 vol.-% O<sub>2</sub> (100 vol.-% N<sub>2</sub>, analyzed test gas directly exposed to the sensor head) and 20.9 vol.-% O<sub>2</sub> (ambient air).
- **Humidity** (CBF / CBF-UL): 93 % r.h.



Repeated calibrations are recommended in periods of 12 months.

For temperature and humidity calibration and adjustment, BINDER service uses electronic measuring and display devices traceable to an acknowledged standards/calibration institution (DKD or PTB for Germany) with a valid calibration certificate.

Test gases with an analyzed concentration serve to calibrate the sensor systems for CO<sub>2</sub> and O<sub>2</sub> (chamber with O<sub>2</sub> control). The sensor heads are exposed directly to the test gas.

### 24.2 Over current protection

The chamber is protected by a chamber-protection against over current, accessible from the outside. It is located at the rear of the chamber below the strain relief of the power cord. The fuse holder is equipped with a fuse clip 5mm x 20 mm (CB) or 6.3 x32 mm (CB-UL). Replace this fuse only with a substitute of the same ratings. Refer to the technical data of the respective device type. If this fuse is blown, please inform an electronic engineer or BINDER service.



### 24.3 Definition of usable volume

The usable volume illustrated below is calculated as follows:

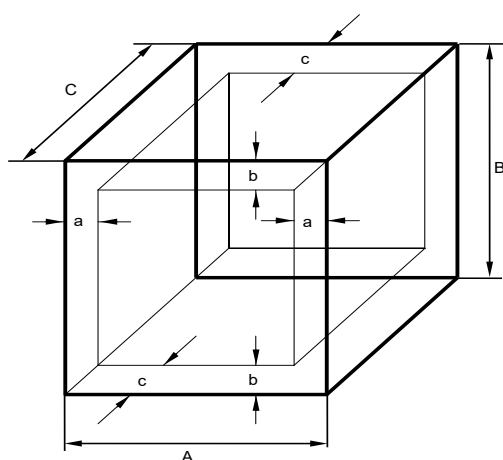

A, B, C = internal dimensions (W, H, D)

a, b, c = wall separation

$$a = 0.1 \cdot A$$

$$b = 0.1 \cdot B$$

$$c = 0.1 \cdot C$$

$$V_{USE} = (A - 2 \cdot a) \cdot (B - 2 \cdot b) \cdot (C - 2 \cdot c)$$

Figure 54: Determination of the usable volume

The technical data refers to the defined usable volume.



Do NOT place samples outside this usable volume.

Do NOT load this volume by more than half to enable sufficient airflow inside the chamber.

Do NOT divide the usable volume into separate parts with large area samples.

Do NOT place samples too close to each other in order to permit circulation between them and thus obtain a homogenous distribution of temperature, CO<sub>2</sub>, O<sub>2</sub> (chamber with O<sub>2</sub> control), and humidity.

### 24.4 Technical data

Chamber size		56	170	260
<b>Exterior dimensions</b>				
Width, net	mm / inch	520 / 20.47	680 / 26.77	740 / 29.13
Height including feet	mm / inch	675 / 26.57	870 / 34.25	1025 / 40.35
Depth, net	mm / inch	550 / 21.65	715 / 28.15	775 / 30.51
Depth plus door handle, I-triangle	mm / inch	55 / 2.16	55 / 2.16	55 / 2.16
Depth plus power connection and gas connection	mm / inch	10 / 0.39	10 / 0.39	10 / 0.39
Wall clearance rear (minimum)	mm / inch	100 / 3.94	100 / 3.94	100 / 3.94
Wall clearance side (minimum)	mm / inch	50 / 1.97	50 / 1.97	50 / 1.97
<b>Doors</b>				
Quantity of outer doors		1	1	1
Quantity of inner doors (inner glass door or divided inner door)		1	1	1
Quantity of individual inner glass doors (with divided inner door)		4	6	8
<b>Interior dimensions</b>				
Width	mm / inch	400 / 15.75	560 / 22.05	620 / 24.41
Height	mm / inch	400 / 15.75	600 / 23.62	750 / 29.53
Depth	mm / inch	330 / 12.99	500 / 19.69	560 / 22.05
Interior volume	L / cu.ft.	53 / 1.9	170 / 6.0	260 / 9.2

Chamber size		56	170	260	
<b>Shelves</b>					
Number of shelves, regular		2	3	4	
Number of shelves, max.		3	6	8	
Size of shelf (external) Width x Depth	mm x mm <i>inch x inch</i>	396 x 289 <i>15.59 x 11.38</i>	551 x 442 <i>21.69 x 17.40</i>	614 x 502 <i>24.17 x 19.76</i>	
Maximum load per shelf	Kg / lbs.	10 / 22	10 / 22	10 / 22	
Permitted total load	Kg / lbs	30 / 66	30 / 66	40 / 88	
<b>Weight</b>					
Weight (empty) CB / CB-UL	Kg / lbs	53 / 116.9	95 / 209.4	121 / 266.8	
Weight (empty) CBF / CBF-UL	Kg / lbs	---	97 / 213.8	122 / 268.9	
<b>CB / CB-UL temperature data</b>					
Temperature range	from ... degree above ambient	°C / °F	4 / 7.2	4 / 7.2	5 / 9.0
	up to	°C / °F	60 / 140	60 / 140	60 / 140
Temperature range, chamber with O <sub>2</sub> control	from ... degree above ambient	°C / °F	6 / 10.8	6 / 10.8	6 / 10.8
	up to	°C / °F	60 / 140	60 / 140	60 / 140
Temperature fluctuation at 37 °C / 98.6 °F	± K	0.1	0.1	0.1	
Temperature uniformity (variation) at 37 °C / 98.6 °F	± K	0.4	0.3	0.4	
Recovery time after door was opened for 30 sec at 37 °C / 98.6 °F	minutes	5	6	6	
<b>CBF / CBF-UL temperature data</b>					
Temperature range	from ... degree above ambient	°C / °F	---	5 / 9	6 / 10.8
	up to	°C / °F	---	60 / 140	60 / 140
Temperature range, chamber with O <sub>2</sub> control	from ... degree above ambient	°C / °F	---	7 / 12.6	6 / 10.8
	up to	°C / °F	---	60 / 140	60 / 140
Temperature fluctuation at 37 °C / 98.6 °F	± K	---	0.1	0.1	
Temperature uniformity (variation) at 37 °C / 98.6 °F	± K	---	0.4	0.4	
Recovery time after door was opened for 30 sec at 37 °C / 98.6 °F	minutes	---	6	6	
<b>CO<sub>2</sub> data</b>					
CO <sub>2</sub> range	vol.-% CO <sub>2</sub>	0 to 20	0 to 20	0 to 20	
Setting accuracy	vol.-% CO <sub>2</sub>	0.1	0.1	0.1	
CO <sub>2</sub> fluctuation	vol.-% CO <sub>2</sub>	0.1	0.1	0.1	
Recovery time after door was opened for 30 sec at 5 vol.-% CO <sub>2</sub>	minutes	5	5	5	
CO <sub>2</sub> measurement		IR	IR	IR	
Connection hose nozzle DN6 for CO <sub>2</sub> connection to the chamber for hose with internal diameter	mm / inch	6 / 0.24	6 / 0.24	6 / 0.24	
<b>Humidity data</b>					
CB / CB-UL humidity range	% r.h.	90 to 95	90 to 95	90 to 95	
CBF / CBF-UL humidity range	% r.h.	---	50 to 95	50 to 95	

Chamber size		56	170	260	
<b>Humidity data (continued)</b>					
Recovery time after door was opened for 30 sec at 90 % r.h. (CBF / CBF-UL)	minutes	---	12	15	
<b>O<sub>2</sub> Data (chamber with O<sub>2</sub> control)</b>					
O <sub>2</sub> range (regular hypoxic control range)	vol.-% O <sub>2</sub>	0.2 to 20	0.2 to 20	0.2 to 20	
O <sub>2</sub> range (optional alternative control range)	vol.-% O <sub>2</sub>	10 to 90	10 to 90	10 to 90	
Setting accuracy with inlet pressure 2 bar	vol.-% O <sub>2</sub>	0.1	0.1	0.1	
O <sub>2</sub> fluctuation	vol.-% O <sub>2</sub>	0.1	0.1	0.1	
Recovery time after door was opened for 30 sec at 5 vol.-% O <sub>2</sub>	minutes	5	10	15	
O <sub>2</sub> measurement		ZrO <sub>2</sub>	ZrO <sub>2</sub>	ZrO <sub>2</sub>	
Connection hose nozzle DN6 for O <sub>2</sub> /N <sub>2</sub> connection to the chamber for hose with internal diameter	mm / inch	6 / 0.24	6 / 0.24	6 / 0.24	
<b>Electrical data</b>					
IP system of protection acc. to EN 60529	IP	20	20	20	
Nominal voltage (+/-10 %)	at 50 Hz power frequency	V	200-230	200-230	200-230
	at 60 Hz power frequency	V	200-230	200-230	200-230
Current type		1N~	1N~	1N~	
CB / CB-UL nominal power	kW	0.80	1.30	1.50	
CBF / CBF-UL nominal power	kW	---	1.60	1.60	
Power plug (IEC connector plug)		Grounded plug IEC 7/7			
Installation category acc. to IEC 61010-1		II	II	II	
Pollution degree acc. to IEC 61010-1		2	2	2	
Chamber fuse 4x20mm / 250V / time-lag (T), external	Amp	10	10	10	
Additional temperature fuse class 1 (DIN 12880), internal	°C	240	240	240	
<b>Different electrical data for CB-UL / CBF-UL constructed for the USA and Canada</b>					
Nominal voltage (+/-10 %)	at 50 Hz power frequency	V	100-120	100-120	100-120
	at 60 Hz power frequency	V	100-120	100-120	100-120
Current type		1N~	1N~	1N~	
Power plug	NEMA	5-20P	5-20P	5-20P	
Chamber fuse 5x20mm / 250V / time-lag (T), external	Amp	12.5	16	16	
<b>Environment-specific data</b>					
Noise level (mean value)	dB (A)	41	41	41	
Energy consumption at 37 °C/ 98.6 °F	Wh/h	45	55	65	

**Notes:**

- The recovery times of the gas concentrations inside the chamber after the door is opened coincide with a connection pressure of 2.0 bar / 29 psi. Decreasing supply pressure results in longer recovery times.
- The specified recovery times can be observed with a door opening of up to 60s. If the outer door is left open for more than 3 minutes, all heaters are deactivated. It is then necessary to let the chamber equilibrate again.

All technical data is specified for unloaded chambers with standard equipment at an ambient temperature of 22 +/- 3 °C / 71.6 +/- 5.4 °F and a power supply voltage fluctuation of +/-10%. Technical data is determined in accordance to BINDER Factory Standard Part 2:2015 and DIN 12880:2007.

**All indications are average values, typical for chambers produced in series. We reserve the right to change technical specifications at any time.**



CBF / CBF-UL: Bringing a source of humidity into the inner chamber will affect the minimum humidity specification

## 24.5 Equipment and Options (extract)



To operate the chamber, use only original BINDER accessories or accessories / components from third-party suppliers authorized by BINDER. The user is responsible for any risk arising from using unauthorized accessories.

Regular equipment
Multifunction touchscreen controller MB2 for temperature, CO <sub>2</sub> , O <sub>2</sub> (chamber with O <sub>2</sub> control) and humidity (CBF / CBF-UL)
CO <sub>2</sub> infra-red absorption measuring system
Silicone jacket heating
Hot-air auto sterilization
Gas mixing head
Permadyry™ humidity system (CB / CB-UL)
Weldless deep-drawn polished inner chamber made of stainless steel 1.4301/V2A, polished
FailSafe – Electronic error auto-diagnosis system
Zero-voltage relay alarm output with DIN socket (6 poles), DIN plug included
Lockable door
Tightly closing inner glass door
3 perforated shelves, stainless steel 1.4301/V2A
Overtemperature safety controller class 3.1 acc. to DIN 12880:2007
CBF / CBF-UL: Microprocessor controlled humidifying system
<i>Chamber with O<sub>2</sub> control: O<sub>2</sub> control in the hypoxic control range 0.2 to 20 vol. % O<sub>2</sub>.</i>
Ethernet interface for computer communication

Options / accessories
Perforated shelf, stainless steel
Perforated shelf, full copper
<i>Chamber with O<sub>2</sub> control: Alternative control range 10 to 90 vol. % O<sub>2</sub></i>
Divided inner door with cell therapy compartmentation, stainless steel, 4 times (size 56), 6 times incubator (size 170), 8 times (incubator size 260)
Shelves for divided inner door, stainless steel
Partition wall for cell therapy compartmentation
Quick sample access
Stacking stand with castors lockable by breaks (incubator size 170 / 210)
Stacking adapter for direct, thermally decoupled stacking
Base with castors
Stacking adapter for combination C / C-UL 150 on top of CB / CB-UL / CBF / CBF-UL 170
Silicone access ports closable with 2 silicone plugs
BINDER Gas Supply Service: External CO <sub>2</sub> bottle changer for CO <sub>2</sub> , O <sub>2</sub> , or N <sub>2</sub>
Connection kit for CO <sub>2</sub> , O <sub>2</sub> or N <sub>2</sub> cylinder
Water tight internal socket 230 V (max. 3 A), with turn-off switch (available via BINDER INDIVIDUAL Customized Solutions)
Analog output temperature and CO <sub>2</sub> 4-20 mA 4-20mA with DIN socket (6 poles), DIN plug included
BINDER Pure Aqua Service
Cartridge for BINDER Pure Aqua Service

Options / accessories
Cleaning kit (neutral cleaning agent, disinfection spray and lint-free disposable wipes, gloves and goggles)
CELLROLL roller system with set of connection cables for extra-low voltage access port
Access port (8-pin) for extra-low voltage (ELV) with LEMO socket (can be covered) and LEMO connector, maximum power rating 24VAC/DC – 2.5 Amp
Gas fine filter with two connection pieces
CBF / CBF-UL: Freshwater bag (0.9 liters / 0.32 cu.ft.)
CBF / CBF-UL: Tubular bag set incl. accessories. Set with 3 or 12 tubular bags (annual demand)
CBF / CBF-UL: Humidification water set incl. accessories
CBF / CBF-UL: Water container set incl. accessories
Qualification folder
Calibration of temperature including certificate
Calibration of CO <sub>2</sub> including certificate
Spatial temperature measurement including certificate
Spatial temperature measurement acc. to DIN 12880 including certificate
<i>Chamber with O<sub>2</sub> control</i> : Calibration of O <sub>2</sub> including certificate
CBF / CBF-UL: Calibration of humidity including certificate
CBF / CBF-UL: Spatial temperature and humidity measurement including certificate

## 24.6 Accessories and spare parts (extract)

	BINDER GmbH is responsible for the safety features of the chamber only, provided skilled electricians or qualified personnel authorized by BINDER perform all maintenance and repair, and if components relating to chamber safety are replaced in the event of failure with original spare parts. The user is responsible for any risks arising from using unauthorized accessories/components.
---	--

Chamber size	56	170	260
Description	Art. no.		
Perforated shelf, stainless steel	6004-0136	6004-0137	6004-0197
Perforated shelf, full copper	---	6004-0233	---
Divided inner door with cell therapy compartmentation Variant 8612-0029 <ul style="list-style-type: none"> <li>• 4 inner doors</li> <li>• 2 shelf levels with one partition wall each</li> </ul>	Door hinged right: 8012-2023 Door hinged left: 8012-2026	---	---
Divided inner door with cell therapy compartmentation Variant 8612-0030 <ul style="list-style-type: none"> <li>• 6 inner doors</li> <li>• 3 shelf levels with one partition wall each</li> </ul>	---	Door hinged right: 8012-2024 Door hinged left: 8012-2027	---
Divided inner door with cell therapy compartmentation Variant 8612-0031 <ul style="list-style-type: none"> <li>• 8 inner doors</li> <li>• 4 shelf levels with one partition wall each</li> </ul>	---	---	Door hinged right: 8012-2025 Door hinged left: 8012-2028

Chamber size	56	170	260
Description	Art. no.		
Partition wall for cell therapy compartmentation	4020-1218	4020-1219	4020-1220
Divided shelves (1 level) for divided inner door, stainless steel	---	6004-0226	6004-0227
Extra-deep shelf for divided inner door, stainless steel	6004-0120	---	---
Door gasket for outer chamber door	6005-0294	6005-0275	6005-0296
Door gasket for inner glass door or for divided inner door	6005-0312	6005-0508	6005-0314
Door gasket for individual glass door of divided inner door	6005-0311	6005-0293	6005-0305
Individual glass door of divided inner door, complete	6005-0135	8010-0110	8010-0116
Flat stacking adapter for direct, thermally decoupled stacking	9051-0038	9051-0035	9051-0039
Stacking stand with castors lockable by breaks	---	9051-0040	9051-0041
Base with castors	9051-0043	9051-0028	9051-0044
Stacking adapter for combination C / C-UL 150/160/170 on top of CB / CB-UL / CBF / CBF-UL 170	---	9051-0027	---
CELLROLL roller system with set of connection cables and extra-low voltage access port	---	8012-0571	8012-0572
Permadyr™ water pan, stainless steel (CB / CB-UL)	6006-0626	4022-0081	6006-0441
Permadyr™ water pan, stainless steel, with divided inner door option (CB / CB-UL)	6006-0666	---	---
Permadyr™ water pan, full copper (CB / CB-UL)	---	4022-0086	---

Description	Art. no.
Plug for optional silicon access port d30	6016-0035
Gas cylinder connection kit for CO <sub>2</sub>	8012-0014
Gas cylinder connection kit for O <sub>2</sub>	8012-0015
Gas cylinder connection kit for N <sub>2</sub>	8012-0016
Chamber fuse 5x20mm 250 V 10 A time-lag (T)	5006-0088
Chamber fuse 6.3x32mm 250V 12.5 A time-lag (T) for cUL version only	5006-0096
CO <sub>2</sub> sensor	5002-0078
O <sub>2</sub> sensor for chamber with regular equipment: hypoxic control range 0.2 up to 20 vol.-% O <sub>2</sub>	5002-0084
O <sub>2</sub> sensor for chamber with O <sub>2</sub> control with optional alternative control range 10 up to 90 vol.-% O <sub>2</sub>	5002-0085
CBF / CBF-UL : Humidity sensor	5002-0077
Gas fine filter with two connection pieces	8009-0369
CBF / CBF-UL : Fresh water bag (0.9 liters / 0.32 cu.ft.)	6002-0626

Description	Art. no.
CBF / CBF-UL : Bag set incl. accessories with 3 empty tubular bags (included with delivery): <ul style="list-style-type: none"> <li>• 3 empty tubular bags (art.no. 6002-0626. 6002-0626)</li> <li>• 3 two-piece tube connectors with 3-5mm nozzles (art.no. 6009-0322)</li> <li>• 3 two-piece tube connectors with 5-7mm nozzles (art.no. 6009-0323)</li> <li>• 3 gas fine filters (sterile filter) (art.no. 6014-0012)</li> <li>• 6 m silicone tube (DN 3mm) (art.no. 6008-0267)</li> <li>• 1m filling tube (DN 10 mm) (art.no. 6008-0268)</li> </ul>	8009-1083
CBF / CBF-UL : Bag set incl. accessories (annual demand): <ul style="list-style-type: none"> <li>• 12 empty tubular bags (art.no. 6002-0626. 6002-0626)</li> <li>• 3 two-piece tube connectors with 3-5mm nozzles (art.no. 6009-0322)</li> <li>• 3 two-piece tube connectors with 5-7mm nozzles (art.no. 6009-0323)</li> <li>• 12 gas fine filters (sterile filter) (art.no. 6014-0012)</li> <li>• 6 m silicone tube (DN 3mm) (art.no. 6008-0267)</li> <li>• 1m filling tube (DN 10 mm) (art.no. 6008-0268)</li> </ul>	8009-1058
CBF / CBF-UL : Humidification water set incl. accessories (annual demand): <ul style="list-style-type: none"> <li>• 10 one-liter bottles, prefilled with sterile, deionized water (art.no. 1007-0314)</li> <li>• 3 spike connectors (transfer sets) for sterile liquids (art.no. 6007-0131)</li> <li>• 3 two-piece tube connectors with 3-5mm nozzles (art.no. 6009-0322)</li> <li>• 2 m silicone tube (DN 3mm) (art.no. 6008-0267)</li> <li>• 3 gas fine filters (sterile filter) (art.no. 6014-0012)</li> <li>• 20 cm silicone tube (DN 6 mm) (art.no. 6008-0009)</li> </ul>	8009-1104
CBF / CBF-UL : Water container set incl. accessories (annual demand): <ul style="list-style-type: none"> <li>• Magnetic can holder adjustable in height, consisting of magnetic holder (art.no. 8022-0009) and water can support (art.no. 4021-0724)</li> <li>• Water can, 10 l (art.no. 6011-0192)</li> <li>• Hose coupling with aqua stop (art.no. 6002-0637)</li> <li>• Angular coupling plug with aqua stop (art.no. 6002-0638)</li> <li>• 12 gas fine filters (sterile filter) (art.no. 6014-0012)</li> <li>• 10 m silicone tube (DN 3mm) (art.no. 6008-0267) to the pump or via T-type tube connectors to further chambers</li> <li>• 50 cm silicone tube, d10 x 2 (art.no. 6008-0268)</li> <li>• Reducing connector (tube connector 4/9 mm) (art.no. 6009-0308)</li> <li>• 4 wire tension clamps (art.no. 6009-0281) (2 spare parts)</li> <li>• 3 T-type tube connectors (T-Pieces), 4mm (art.no. 6009-0318)</li> </ul>	8009-1128
CBF / CBF-UL : 1m silicone tube (DN 3mm)	6008-0267
CBF / CBF-UL : Pump head	5013-0204
CBF / CBF-UL : BINDER Pure Aqua Service	8012-0759
CBF / CBF-UL : Cartridge for BINDER Pure Aqua Service	6011-0165
Cleaning kit (neutral cleaning agent, disinfection spray and lint-free disposable wipes, protective gloves and goggles)	8012-0503
Neutral cleaning agent, 1 kg	1002-0016

Validation service	Art. no.
Qualification folder IQ-OQ (printed version)	7007-0001
Qualification folder IQ-OQ (digital version)	7057-0001
Qualification folder IQ-OQ-PQ (printed version)	7007-0005
Qualification folder IQ-OQ-PQ (digital version)	7057-0005
Execution of IQ-OQ	DL410200
Execution of IQ-OQ-PQ	DL440500

Calibration service	Art. no.
Calibration of temperature including certificate	8012-1132
Calibration of temperature and CO <sub>2</sub> including certificate	8012-1235
Calibration of O <sub>2</sub> including certificate (chamber with O <sub>2</sub> control)	8012-0229
Spatial temperature measurement including certificate (15-18 measuring points)	8012-1571
Spatial temperature measurement including certificate (9 measuring points)	8012-1550
Spatial temperature measurement including certificate (27 measuring points)	8012-1592
Spatial temperature and humidity measurement including certificate (27 measuring points for temperature, 1 measuring point for humidity)	8012-0924

For information on components not listed here, please contact BINDER Service.

## 24.7 Important conversion data for non-SI units

1 ft = 0.305 m

1 m = 100 cm = 3.28 ft = 39.37 inch

1 mbar = 0.0145 psi

## 24.8 Conversion table for gas inlet pressures, bar – psi

bar	psi	bar	psi	bar	psi
1	14.5	3	43.5	5	72.5
1.5	21.7	3.5	50.7	5.5	79.7
2	29.0	4	58.0	6	87.0
2.5	36.3	4.5	65.2		



## 24.9 Dimensions

### 24.9.1 Chamber size 56

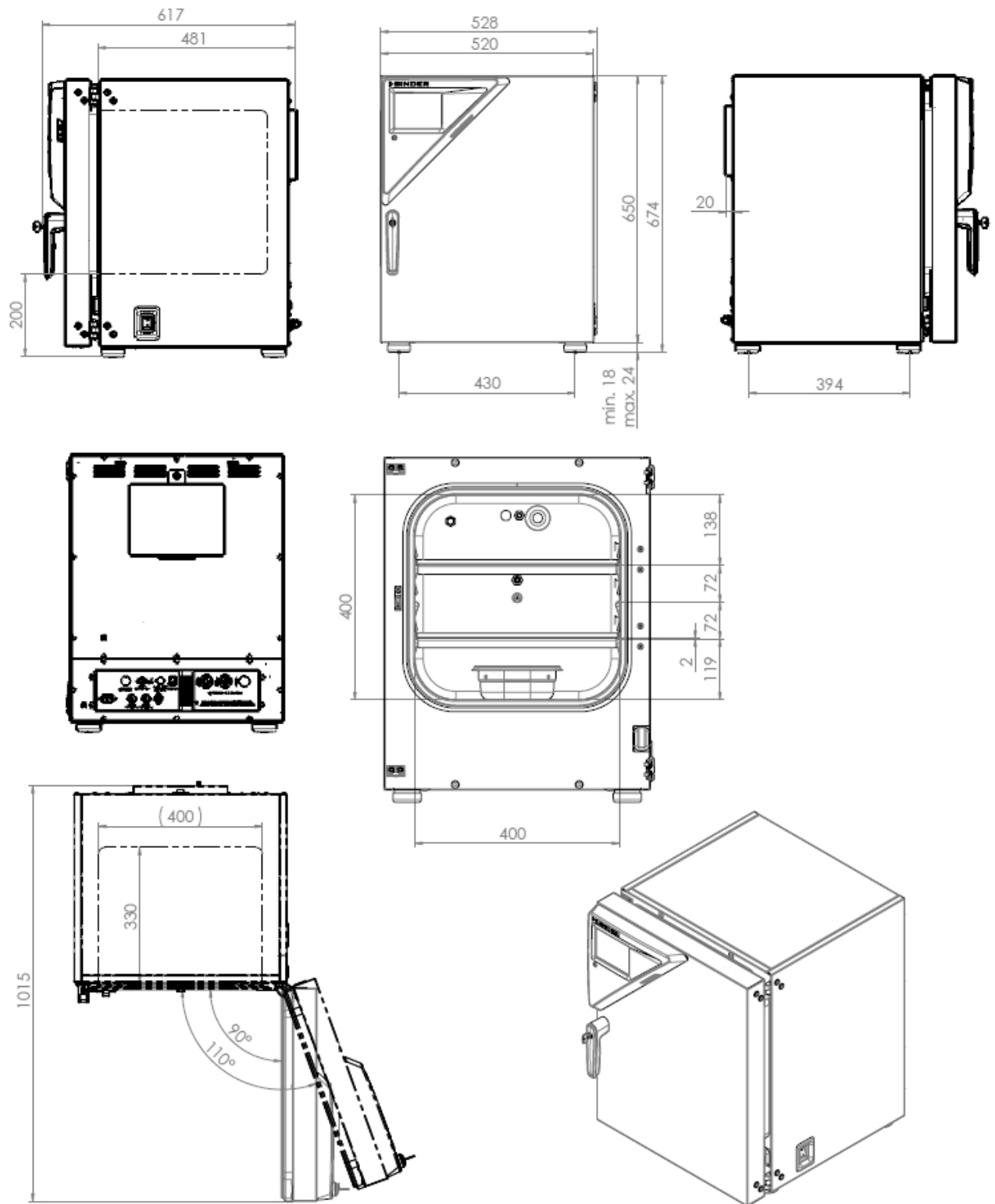

(Dimensions in mm)

## 24.9.2 Chamber size 170

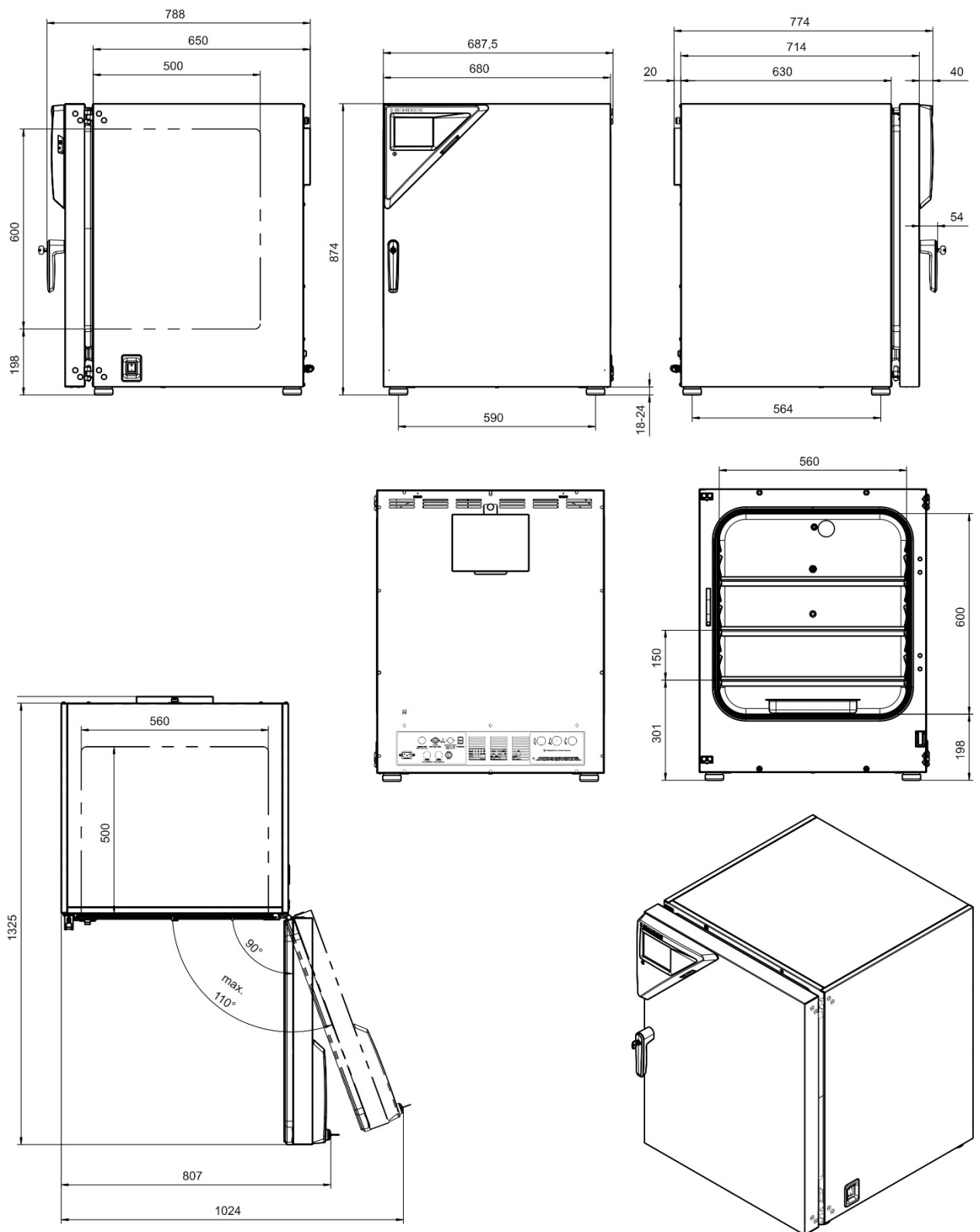

(Dimensions in mm)

### 24.9.3 Chamber size 260

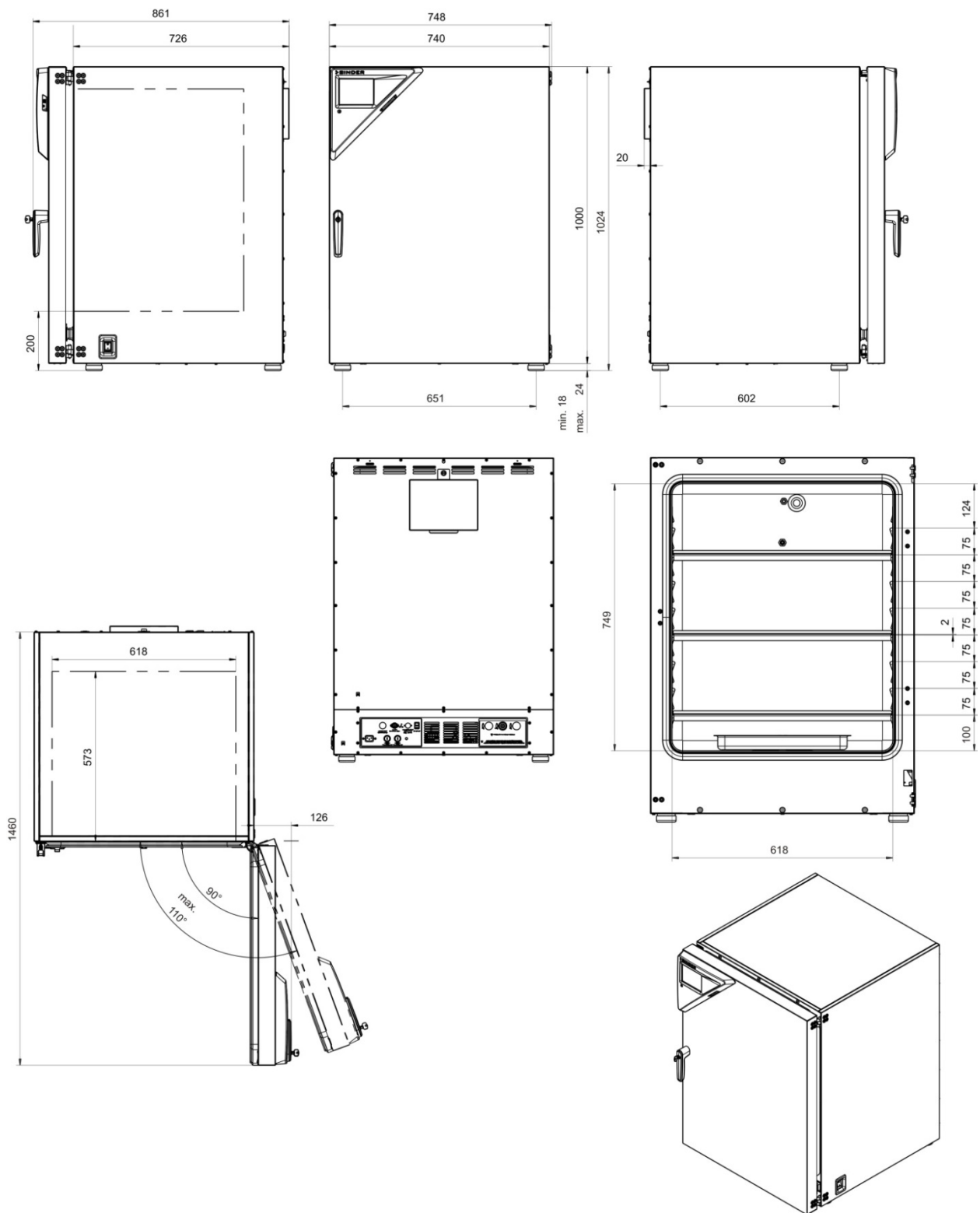

(Dimensions in mm)

## 25. Certificates and declarations of conformity

### 25.1 EU Declaration of conformity for CB

**CE** EU-Konformitätserklärung / EU Declaration of Conformity / Déclaration de conformité UE / Declaración de conformidad UE / Dichiarazione di conformità UE / Декларация соответствия EU

Hersteller / Manufacturer / Fabricant / Fabricante / Fabbicante / Производитель	BINDER GmbH
Anschrift / Address / Adresse / Dirección / Indirizzo / Адрес	Im Mittleren Ösch 5, 78532 Tuttlingen, Germany
Produkt / Product / Produit / Producto / Prodotto / Продукт	CO <sub>2</sub> -Inkubatoren CO <sub>2</sub> Incubators Incubateurs à CO <sub>2</sub> Incubadoras de CO <sub>2</sub> Incubatori a CO <sub>2</sub> CO <sub>2</sub> инкубаторы
Typenbezeichnung / Type / Type / Tipo / Tipo / Тип	CB 56, CB 170, CB 260 (E7)
Art. No. / Art. no. / Réf. / Art. N° / Art. n. / № арт.	9640-0005, 9640-0006, 9640-0007, 9640-0008, 9640-0009, 9640-0010, 9640-0011, 9640-0012, 9640-0013, 9640-0014, 9640-0015, 9640-0016, 9640-0027, 9640-0028

Die oben beschriebenen Produkte sind konform mit folgenden EU-Richtlinien:

The products described above are in conformity with the following EU Directives:

Les produits décrits ci-dessus sont conformes aux directives UE suivantes:

Los productos descritos arriba cumplen con las siguientes directivas de la UE:

I prodotti sopra descritti sono conformi alle seguenti direttive UE:

Продукты, указанные выше, полностью соответствуют следующим EU руководствам:

- **2014/35/EU**  
Niederspannungsrichtlinie 2014/35/EU / Low voltage directive 2014/35/EU / Directive basse tension 2014/35/UE / Directiva sobre baja tensión 2014/35/UE / Direttiva Bassa tensione 2014/35/UE / Директива по низкому напряжению 2014/35/EU
- **2014/30/EU**  
EMV-Richtlinie 2014/30/EU / EMC Directive 2014/30/EU / Directive CEM 2014/30/UE / Directiva CEM 2014/30/UE / Direttiva EMC 2014/30/UE / Директива ЭМС 2014/30/EU
- **2011/65/EU, (EU) 2015/863**  
RoHS-Richtlinien 2011/65/EU und (EU) 2015/863 / RoHS Directives 2011/65/EU and (EU) 2015/863 / Directives RoHS 2011/65/UE et (UE) 2015/863 / Direttivas RoHS 2011/65/UE y (UE) 2015/863 / Direttive RoHS 2011/65/UE et (UE) 2015/863 / Директивы RoHS 2011/65/EU и (EU) 2015/863

1 / 2

Die oben beschriebenen Produkte tragen entsprechend die Kennzeichnung CE.  
The products described above, corresponding to this, bear the CE-mark.  
Les produits décrits ci-dessus, en correspondance, portent l'indication CE.  
Los productos descritos arriba, en conformidad, llevan la indicación CE.  
I prodotti sopra descritti, conformi a quanto sopra, portano il marchio CE.  
Данные продукты в соответствии с изложенным выше маркированы знаком CE.

Die oben beschriebenen Produkte sind konform mit folgenden harmonisierten Normen:  
The products described above are in conformity with the following harmonized standards:  
Les produits décrits ci-dessus sont conformes aux normes harmonisées suivantes:  
Los productos descritos arriba cumplen con las siguientes normas:  
I prodotti sopra descritti sono conformi alle seguenti normative armonizzate:  
Продукты, указанные выше, полностью соответствуют следующим стандартам:

Sicherheit / Safety / Sécurité / Seguridad / Sicurezza / Нормативы по безопасности
<ul style="list-style-type: none"><li>• EN 61010-1:2010+A1:2019+A1:2019/AC:2019</li><li>• EN 61010-2-010:2014</li><li>• EN 60204-1:2018</li></ul>
EMV / EMC / CEM / CEM / EMC / ЭМС
<ul style="list-style-type: none"><li>• EN 61326-1:2013</li></ul>
RoHS
<ul style="list-style-type: none"><li>• EN IEC 63000:2018</li></ul>

78532 Tuttlingen, 11.07.2022

BINDER GmbH



**P. Wimmer**  
Vice President  
Vice President  
Vice président  
Vicepresidente  
vicepresidente  
Вице-президент



**J. Bollaender**  
Leiter F & E  
Director R & D  
Chef de service R&D  
Responsable I & D  
Direttore R & D  
Глава департамента R&D

2 / 2

BINDER GmbH  
Im Mittleren Osch 5  
78502 Tuttlingen  
Deutschland

Tel: +49 (0) 74 62 / 20 05 - 0  
Fax: +49 (0) 74 62 / 20 05 - 100  
info@binder-world.com  
www.binder-world.com

Geschäftsführung:  
Dipl.-Ing. Peter M. Binder  
Amtsgericht Stuttgart, HRB 727150  
Sitz der Gesellschaft: Tuttlingen  
Ust.-ID.-Nr.: DE815021304

Kreissparkasse Tuttlingen  
IBAN: DE05 6435 0070 0000 0022 66  
SWIFT: SOLA DE 31TUT  
Deutsche Bank Tuttlingen  
IBAN: DE56 6537 0075 0213 8709 00  
SWIFT: DEUT DE 33653

## 25.2 EU Declaration of conformity for CBF



**CE** EU-Konformitätserklärung / EU Declaration of Conformity / Déclaration de conformité UE / Declaración de conformidad UE / Dichiarazione di conformità UE / Декларация соответствия EU

Hersteller / Manufacturer / Fabricant / Fabricante / Fabbicante / Производитель	BINDER GmbH
Anschrift / Address / Adresse / Dirección / Indirizzo / Адрес	Im Mittleren Ösch 5, 78532 Tuttlingen, Germany
Produkt / Product / Produit / Producto / Prodotto / Продукт	CO <sub>2</sub> -Inkubatoren CO <sub>2</sub> Incubators Incubateurs à CO <sub>2</sub> Incubadoras de CO <sub>2</sub> Incubatori a CO <sub>2</sub> CO <sub>2</sub> инкубаторы
Typenbezeichnung / Type / Type / Tipo / Tipo / Тип	CBF 170, CBF 260 (E7)
Art. No. / Art. no. / Réf. / Art. N° / Art. n. / № арт.	9640-0017, 9640-0018, 9640-0019, 9640-0020, 9640-0021, 9640-0022, 9640-0023, 9640-0024

Die oben beschriebenen Produkte sind konform mit folgenden EU-Richtlinien:

The products described above are in conformity with the following EU Directives:

Les produits décrits ci-dessus sont conformes aux directives UE suivantes:

Los productos descritos arriba cumplen con las siguientes directivas de la UE:

I prodotti sopra descritti sono conformi alle seguenti direttive UE:

Продукты, указанные выше, полностью соответствуют следующим EU руководствам:

- **2014/35/EU**  
Niederspannungsrichtlinie 2014/35/EU / Low voltage directive 2014/35/EU / Directive basse tension 2014/35/UE / Directiva sobre baja tensión 2014/35/UE / Direttiva Bassa tensione 2014/35/UE / Директива по низкому напряжению 2014/35/EU
- **2014/30/EU**  
EMV-Richtlinie 2014/30/EU / EMC Directive 2014/30/EU / Directive CEM 2014/30/UE / Directiva CEM 2014/30/UE / Direttiva EMC 2014/30/UE / Директива ЭМС 2014/30/EU
- **2011/65/EU, (EU) 2015/863**  
RoHS-Richtlinien 2011/65/EU und (EU) 2015/863 / RoHS Directives 2011/65/EU and (EU) 2015/863 / Directives RoHS 2011/65/UE et (UE) 2015/863 / Directivas RoHS 2011/65/UE y (UE) 2015/863 / Direttive RoHS 2011/65/UE et (UE) 2015/863 / Директивы RoHS 2011/65/EU и (EU) 2015/863

1 / 2

BINDER GmbH Postfach 102 D-78502 Tuttlingen **Anschrift:** BINDER GmbH Im Mittleren Ösch 5 D-78532 Tuttlingen  
**Kontakt:** Telefon: +49 (0) 74 62 / 20 05 – 0 | Telefax: +49 (0) 74 62 / 20 05 – 100 | info@binder-world.com | www.binder-world.com  
**Geschäftsführung:** Dipl.-Ing. Peter M. Binder | Amtsgericht Stuttgart, HRB 727150 | Sitz der Gesellschaft: Tuttlingen  
**Bankverbindung:** Kreissparkasse Tuttlingen | IBAN-Code: DE05 6435 0070 0000 0022 66 | SWIFT-Code: SOLA DE 51TUT  
 \$-IBAN-Code: DE90 6435 0070 0220 2639 71 | SWIFT-Code: SOLA DE 51TUT  
 Deutsche Bank Tuttlingen | IBAN-Code: DE56 6537 0075 0213 8709 00 | SWIFT-Code: DEUT DE 55653  
 Altgeräte-Entsorgung gemäß WEEE-Reg.-Nr. DE 37004983

Die oben beschriebenen Produkte tragen entsprechend die Kennzeichnung CE.

The products described above, corresponding to this, bear the CE-mark.

Les produits décrits ci-dessus, en correspondance, portent l'indication CE.

Los productos descritos arriba, en conformidad, llevan la indicación CE.

I prodotti sopra descritti, conformi a quanto sopra, portano il marchio CE.

Данные продукты в соответствии с изложенным выше маркированы знаком CE.

Die oben beschriebenen Produkte sind konform mit folgenden harmonisierten Normen:

The products described above are in conformity with the following harmonized standards:

Les produits décrits ci-dessus sont conformes aux normes harmonisées suivantes:

Los productos descritos arriba cumplen con las siguientes normas:

I prodotti sopra descritti sono conformi alle seguenti normative armonizzate:

Продукты, указанные выше, полностью соответствуют следующим стандартам:

Sicherheit / Safety / Sécurité / Seguridad / Sicurezza / Нормативы по безопасности
<ul style="list-style-type: none"><li>• EN 61010-1:2010</li><li>• EN 61010-2-010:2014</li></ul>
EMV / EMC / CEM / CEM / EMC / ЭМС
<ul style="list-style-type: none"><li>• EN 61326-1:2013</li></ul>
RoHS
<ul style="list-style-type: none"><li>• EN IEC 63000:2018</li></ul>

78532 Tuttlingen, 29.06.2021

BINDER GmbH



P. Wimmer

Vice President

Vice President

Vice président

Vicepresidente

vicepresidente

Вице-президент



J. Bollaender

Leiter F & E

Director R & D

Chef de service R&D

Responsable I & D

Direttore R & D

Глава департамента R&D

2 / 2

BINDER GmbH Postfach 102 D-78502 Tuttlingen **Anschrift:** BINDER GmbH Im Mittleren Ösch 5 D-78532 Tuttlingen  
Kontakt: Telefon: +49 (0) 74 62 / 20 05 – 0 | Telefax: +49 (0) 74 62 / 20 05 – 100 | info@binder-world.com | www.binder-world.com  
Geschäftsführung: Dipl.-Ing. Peter M. Binder | Amtsgericht Stuttgart, HRB 727150 | Sitz der Gesellschaft: Tuttlingen  
Bankverbindung: Kreissparkasse Tuttlingen | IBAN-Code: DE05 6435 0070 0000 0022 66 | SWIFT-Code: SOLA DE 51TUT  
\$-IBAN-Code: DE90 6435 0070 0220 2639 71 | SWIFT-Code: SOLA DE 51TUT  
Deutsche Bank Tuttlingen | IBAN-Code: DE56 6537 0075 0213 8709 00 | SWIFT-Code: DEUT DE 55653  
Altgeräte-Entsorgung gemäß WEEE-Reg.-Nr. DE 37004983

## 25.3 UKCA Declaration of Conformity for CB



	<h3>UKCA Declaration of Conformity</h3>
---	---

Name and address of manufacturer	BINDER GmbH Im Mittleren Ösch 5, 78532 Tuttlingen, Germany
Name and address of UK Authorised Representative	Comply Express Ltd Unit C2, Coalport House, Stafford Park 1, Telford TF3 3BD
Object of the Declaration	CO <sub>2</sub> Incubators
Type Designation	CB 56, CB 170, CB 260 (E7)
BINDER Art. No.	9640-0005, 9640-0006, 9640-0009, 9640-0010, 9640-0013, 9640-0014, 9640-0027, 9640-0028

The Objects of the Declaration described above are in conformity with the relevant UK Regulations and UK Guidelines:

- **Electrical Equipment (Safety) Regulations 2016**  
Statutory Instruments 2016 No. 1101 – Consumer Protection Health and safety
- **Electromagnetic Compatibility Regulations 2016**  
Statutory Instruments 2016 No. 1091 – Electromagnetic Compatibility
- **The Restriction of the Use of Certain Hazardous Substances in Electrical and Electronic Equipment Regulations 2012**  
Statutory Instruments 2012 No. 3032 – Environmental Protection

References of standards and/or technical specifications applied for this Declaration of Conformity, or parts thereof:

<b>S.I. 2016 No. 1101:</b>	EN 61010-1:2010 EN 61010-2-10 EN 60204-1:2018
<b>S.I. 2016 No. 1091:</b>	EN 61326-1:2013
<b>S.I. 2012 No. 3032:</b>	EN IEC 63000:2018

This Declaration is issued under the sole responsibility of the manufacturer.

	Tuttlingen	11.07.2022	 		
Place	Date		P. Wimmer Vice President	J. Bollaender Director R & D	BINDER GmbH

BINDER GmbH  
Im Mittleren Ösch 5  
78502 Tuttlingen  
Deutschland

Tel: +49 (0) 74 62 / 20 05 - 0  
Fax: +49 (0) 74 62 / 20 05 - 100  
info@binder-world.com  
www.binder-world.com

Geschäftsführung:  
Dipl.-Ing. Peter M. Binder  
Amtsgericht Stuttgart, HRB 727150  
Sitz der Gesellschaft: Tuttlingen  
Ust.-ID.-Nr.: DE815021304

Kreissparkasse Tuttlingen  
IBAN: DE05 6435 0070 0000 0022 66  
SWIFT: SOLA DE 31TUT  
Deutsche Bank Tuttlingen  
IBAN: DE56 6537 0075 0213 8709 00  
SWIFT: DEUT DE 33853



## 25.4 UKCA Declaration of Conformity for CBF



<b>UK CA</b>	<b>UKCA Declaration of Conformity</b>
------------------	---------------------------------------

Name and address of manufacturer	BINDER GmbH Im Mittleren Ösch 5, 78532 Tuttlingen, Germany
Name and address of UK Authorised Representative	Comply Express Ltd Unit C2, Coalport House, Stafford Park 1, Telford TF3 3BD
Object of the Declaration	CO <sub>2</sub> Incubators
Type Designation	CBF 170, CBF 260 (E7)
BINDER Art. No.	9640-0017, 9640-0018, 9640-0021, 9640-0022



The Objects of the Declaration described above are in conformity with the relevant UK Regulations and UK Guidelines:

- **Electrical Equipment (Safety) Regulations 2016**  
Statutory Instruments 2016 No. 1101 – Consumer Protection Health and safety
- **Electromagnetic Compatibility Regulations 2016**  
Statutory Instruments 2016 No. 1091 – Electromagnetic Compatibility
- **The Restriction of the Use of Certain Hazardous Substances in Electrical and Electronic Equipment Regulations 2012**  
Statutory Instruments 2012 No. 3032 – Environmental Protection

References of standards and/or technical specifications applied for this Declaration of Conformity, or parts thereof:

<b>S.I. 2016 No. 1101:</b>	EN 61010-1:2010 EN 61010-2-10 EN 60204-1:2018
<b>S.I. 2016 No. 1091:</b>	EN 61326-1:2013
<b>S.I. 2012 No. 3032:</b>	EN IEC 63000:2018

This Declaration is issued under the sole responsibility of the manufacturer.

Tuttlingen	01.06.2022			
Place	Date	P. Wimmer Vice President	J. Bollaender Director R & D	BINDER GmbH

BINDER GmbH  
Im Mittleren Ösch 5  
78502 Tuttlingen  
Deutschland

Tel: +49 (0) 74 62 / 20 05 - 0  
Fax: +49 (0) 74 62 / 20 05 - 100  
info@binder-world.com  
www.binder-world.com

Geschäftsführung:  
Dipl.-Ing. Peter M. Binder  
Amtsgericht Stuttgart, HRB 727150  
Sitz der Gesellschaft: Tuttlingen  
Ust.-ID.-Nr.: DE815021304

Kreissparkasse Tuttlingen  
IBAN: DE05 6435 0070 0000 0022 66  
SWIFT: SOLA DE 31TUT  
Deutsche Bank Tuttlingen  
IBAN: DE56 6537 0075 0213 8709 00  
SWIFT: DEUT DE 33653

## 26. Contamination clearance certificate

### 26.1 For chambers located outside the USA and Canada

#### Declaration regarding safety and health

Erklärung zur Sicherheit and gesundheitlichen Unbedenklichkeit

The German Ordinance on Hazardous Substances (GefStofV), and the regulations regarding safety at the workplace, require that this form be filled out for all products that are returned to us, so that the safety and the health of our employees can be guaranteed.

Die Sicherheit und Gesundheit unserer Mitarbeiter, die Gefahrstoffverordnung GefStofV und die Vorschriften zur Sicherheit am Arbeitsplatz machen es erforderlich, dass dieses Formblatt für alle Produkte, die an uns zurückgeschickt wird.



Note: A repair is not possible without a completely filled out form.  
Ohne Vorliegen des vollständig ausgefüllten Formblattes ist eine Reparatur nicht möglich.

- A completely filled out form must be transmitted via Fax (+49 (0) 7462 2005 93555) or by letter in advance, so that this information is available before the equipment/component part arrives. A second copy of this form must accompany the equipment/component part. In addition, the carrier should be informed.

Eine vollständig ausgefüllte Kopie dieses Formblattes soll per Telefax (Nr. +49 (0) 7462 2005 93555) oder Brief vorab an uns gesandt werden, so dass die Information vorliegt, bevor das Gerät/Bauteil eintrifft. Eine weitere Kopie soll dem Gerät/Bauteil beigefügt sein. Ggf. ist auch die Spedition zu informieren.

- Incomplete information or non-conformity with this procedure will inevitably lead to substantial delays in processing. Please understand the reason for this measure, which lies outside our area of influence and will help us to speed up this procedure.

Unvollständige Angaben oder Nichteinhalten dieses Ablaufs führen zwangsläufig zu beträchtlichen Verzögerungen in der Abwicklung. Bitte haben Sie Verständnis für Maßnahmen, die außerhalb unserer Einflussmöglichkeiten liegen und helfen Sie mit, den Ablauf beschleunigen.

- **Please print and fill out this form completely.**

Bitte unbedingt vollständig ausfüllen!

<b>1.</b>	<b>Chamber/ component part / type: / Gerät / Bauteil / Typ:</b>
<b>2.</b>	<b>Serial No./ Serien-Nr.:</b>
<b>3.</b>	<b>Details about utilized substances / biological substances / Einzelheiten über die eingesetzten Substanzen/biologische Materialien:</b>
<b>3.1</b>	<b>Designations / Bezeichnungen:</b>
a)	_____
b)	_____
c)	_____
<b>3.2</b>	<b>Safety measures required for handling these substances / Vorsichtsmaßnahmen beim Umgang mit diesen Stoffen:</b>
a)	_____
b)	_____
c)	_____

<b>3.3</b>	<b>Measures to be taken in case of skin contact or release into the atmosphere / Maßnahmen bei Personenkontakt oder Freisetzung:</b>
	a) _____
	b) _____
	c) _____
	d) _____
<b>3.4</b>	<b>Other important information that must be taken into account / Weitere zu beachtende und wichtige Informationen:</b>
	a) _____
	b) _____
	c) _____
<b>4.</b>	<b>Declaration on the risk of these substances (please checkmark the applicable items) / Erklärung zur Gefährlichkeit der Stoffe (bitte Zutreffendes ankreuzen) :</b>
<input type="checkbox"/>	<b>4.1 For non-toxic, non-radioactive, biologically harmless materials / für nicht giftige, nicht radioaktive, biologisch ungefährliche Stoffe:</b>
	<b>We hereby guarantee that the above-mentioned chamber / component part... / Wir versichern, dass o.g. Gerät/Bauteil...</b>
<input type="checkbox"/>	Has not been exposed to or contains any toxic or otherwise hazardous substances / weder giftige noch sonstige gefährliche Stoffe enthält oder solche anhaften.
<input type="checkbox"/>	That eventually generated reaction products are non-toxic and also do not represent a hazard / auch evtl. entstandene Reaktionsprodukte weder giftig sind noch sonst eine Gefährdung darstellen.
<input type="checkbox"/>	Eventual residues of hazardous substances have been removed / evtl. Rückstände von Gefahrstoffen entfernt wurden.
<input type="checkbox"/>	<b>4.2 For toxic, radioactive, biologically harmful or hazardous substances, or any other hazardous materials / für giftige, radioaktive, biologisch bedenkliche bzw. gefährliche Stoffe oder anderweitig gefährliche Stoffe.</b>
	<b>We hereby guarantee that ... / Wir versichern, dass ...</b>
<input type="checkbox"/>	The hazardous substances, which have come into contact with the above-mentioned equipment/component part, have been completely listed under item 3.1 and that all information in this regard is complete / die gefährlichen Stoffe, die mit dem o.g. Gerät/Bauteil in Kontakt kamen, in 3.1 aufgelistet sind und alle Angaben vollständig sind.
<input type="checkbox"/>	That the chamber /component part has not been in contact with radioactivity / das Gerät/Bauteil nicht mit Radioaktivität in Berührung kam
<b>5.</b>	<b>Kind of transport / transporter / Transportweg/Spediteur:</b>
	Transport by (means and name of transport company, etc.) / Versendung durch (Name Spediteur o.ä.)
	_____
	Date of dispatch to BINDER GmbH / Tag der Absendung an BINDER GmbH:
	_____

**We hereby declare that the following measures have been taken / Wir erklären, dass folgende Maßnahmen getroffen wurden:**

- Hazardous substances were removed from the chamber including component parts, so that no hazard exists for any person in the handling or repair of these items / das Gerät/Bauteil wurde von Gefahrstoffen befreit, so dass bei Handhabung/Reparaturen für die betreffenden Person keinerlei Gefährdung besteht
- The chamber was securely packaged and properly identified / das Gerät wurde sicher verpackt und vollständig gekennzeichnet.
- Information about the hazardousness of the shipment (if required) has been provided to the transporter / der Spediteur wurde (falls vorgeschrieben) über die Gefährlichkeit der Sendung informiert.

We hereby commit ourselves and guarantee that we will indemnify BINDER GmbH for all damages that are a consequence of incomplete or incorrect information provided by us, and that we will exempt BINDER GmbH from eventual damage claims by third parties./ Wir versichern, dass wir gegenüber BINDER für jeden Schaden, der durch unvollständige und unrichtige Angaben entsteht, haften und BINDER gegen eventuell entstehende Schadenansprüche Dritter freistellen.

We are aware that, in accordance with Article 823 of the German Civil Code (BGB), we are directly liable with regard to third parties, in this instance especially the employees of BINDER GmbH, who have been entrusted with the handling / repair of the chamber / component. / Es ist uns bekannt, dass wir gegenüber Dritten – hier insbesondere mit der Handhabung/Reparatur des Geräts/des Bauteils betraute Mitarbeiter der Firma BINDER - gemäß §823 BGB direkt haften

Name: \_\_\_\_\_

Position/Title: \_\_\_\_\_

Date / Datum: \_\_\_\_\_

Signature / Unterschrift: \_\_\_\_\_

Company stamp / Firmenstempel:



Equipment that is returned to the factory for repair must be accompanied by a completely filled out contamination clearance certificate. For service and maintenance on site, such a contamination clearance certificate must be submitted to the service technician before the start of any work. No repair or maintenance of the equipment is possible, without a properly filled out contamination clearance certificate.

## 26.2 For chambers in the USA and Canada

### Product Return Authorization Request

Please complete this form and the Customer Decontamination Declaration (next 2 pages) and attach the required pictures. E-mail to: IDL\_SalesOrderProcessing\_USA@binder-world.com

After we have received and reviewed the complete information we will decide on the issue of a RMA number. Please be aware that size specifications, voltage specifications as well as performance specifications are available on the internet at [www.binder-world.us](http://www.binder-world.us) at any time.

Take notice of shipping laws and regulations.

	Please fill:	
Reason for return request	<input type="radio"/> Duplicate order	
	<input type="radio"/> Duplicate shipment	
	<input type="radio"/> Demo	<i>Page one completed by sales</i>
	<input type="radio"/> Power Plug / Voltage	115V / 230 V / 208 V / 240V
	<input type="radio"/> Size does not fit space	
	<input type="radio"/> Transport Damage	Shock watch tripped? ( <i>pictures</i> )
	<input type="radio"/> Other (specify below)	
	_____	
Is there a replacement PO?	<input type="radio"/> Yes <input type="radio"/> No	
<i>If yes -&gt; PO #</i>		
<i>If yes -&gt; Date PO placed</i>		
Purchase order number		
BINDER model number		
BINDER serial number		
Date chamber was received		
Was the chamber unboxed?	<input type="radio"/> Yes <input type="radio"/> No	
Was the chamber plugged in?	<input type="radio"/> Yes <input type="radio"/> No	
Was the chamber in operation?	<input type="radio"/> Yes <input type="radio"/> No	
<i>Pictures of chamber attached?</i> <i>Pictures of Packaging attached?</i>	<input type="radio"/> Yes <input type="radio"/> No <input type="radio"/> Yes <input type="radio"/> No	Pictures have to be attached!

	Customer Contact Information	Distributor Contact Information
Name		
Company		
Address		
Phone		
E-mail		

## Customer (End User) Decontamination Declaration

### Health and Hazard Safety declaration

To protect the health of our employees and the safety at the workplace, we require that this form is completed by the user for all products and parts that are returned to us. (Distributors or Service Organizations cannot sign this form)

	<p>NO RMA number will be issued without a completed form. Products or parts returned to our NY warehouse without a RMA number will be refused at the dock.</p>
---	--

A second copy of the completed form must be attached to the outside of the shipping box.

<b>1.</b>	<b>Chamber/ component part / type:</b>
<b>2.</b>	<b>Serial No.</b>
<b>3.</b>	<b>List any exposure to hazardous liquids, gasses or substances and radioactive material</b>
<b>3.1</b>	<b>List with MSDS sheets attached where available or needed (if there is not enough space available below, please attach a page):</b>
a)	_____
b)	_____
c)	_____
<b>3.2</b>	<b>Safety measures required for handling the list under 3.1</b>
a)	_____
b)	_____
c)	_____
<b>3.3</b>	<b>Measures to be taken in case of skin contact or release into the atmosphere:</b>
a)	_____
b)	_____
c)	_____
d)	_____
<b>3.4</b>	<b>Other important information that must be considered:</b>
a)	_____
b)	_____
c)	_____

**4. Declaration of Decontamination**

**For toxic, radioactive, biologically and chemically harmful or hazardous substances, or any other hazardous materials.**

**We hereby guarantee that**

- 4.1 Any hazardous substances, which have come into contact with the above-mentioned equipment / component part, have been completely listed under item 3.1 and that all information in this regard is complete.
- 4.2 That the chamber /component part has not been in contact with radioactivity
- 4.3 Any Hazardous substances were removed from the chamber / component part, so that no hazard exists for a person in the shipping, handling or repair of these returned chamber
- 4.4 The chamber was securely packaged in the original undamaged packaging and properly identified on the outside of the packaging material with the chamber designation, the RMA number and a copy of this declaration.
- 4.5 Shipping laws and regulations have not been violated.

**I hereby commit and guarantee that we will indemnify BINDER Inc. for all damages that are a consequence of incomplete or incorrect information provided by us, and that we will indemnify and hold harmless BINDER Inc. from eventual damage claims by third parties.**

Name: \_\_\_\_\_

Position: \_\_\_\_\_

Company: \_\_\_\_\_

Address: \_\_\_\_\_

Phone #: \_\_\_\_\_

Email: \_\_\_\_\_

Date: \_\_\_\_\_

Signature: \_\_\_\_\_



Equipment returned to the NY warehouse for repair must be accompanied by a completed customer decontamination declaration. For service and maintenance works on site, such a customer decontamination declaration must be submitted to the service technician before the start of work. No repair or maintenance of the equipment is possible without a completed form.