

# Operating Manual

Translation of the original operating manual

## M (E3.1)

### Drying and heating ovens with forced convection and advanced program functions

with microprocessor temperature controller

Model	Model version	Art. No.
M 56 (E3.1)	M056-230V	9010-0371, 9110-0371
M 115 (E3.1)	M115-230V	9010-0372, 9110-0372
M 260 (E3.1)	M260-400V	9010-0373, 9110-0373
M 720 (E3.1)	M720-400V	9010-0374, 9110-0374

#### **BINDER GmbH**

- ▶ Address: Post office box 102, 78502 Tuttlingen, Germany ▶ Phone: +49 7462 2005 0
- ▶ Fax: +49 7462 2005 100 ▶ Internet: <http://www.binder-world.com>
- ▶ Service Hotline: +49 7462 2005 555
- ▶ Service Fax: +49 7462 2005 93 555
- ▶ Service Hotline USA: +1 866 885 9794 or +1 631 224 4340 x3
- ▶ Service Hotline Asia Pacific: +852 390 705 04 or +852 390 705 03

## Content

<b>1. SAFETY</b>	<b>6</b>
1.1 Personnel Qualification	6
1.2 Operating manual	6
1.3 Legal considerations	6
1.3.1 Intellectual property	7
1.4 Structure of the safety instructions	7
1.4.1 Signal word panel	7
1.4.2 Safety alert symbol	8
1.4.3 Pictograms	8
1.4.4 Word message panel structure	9
1.5 Localization / position of safety labels on the chamber	9
1.6 Type plate	10
1.7 UKCA Label	11
1.8 General safety instructions on installing and operating the chambers	11
1.9 Intended use	13
1.10 Foreseeable Misuse	14
1.11 Residual Risks	15
1.12 Operating instructions	16
1.13 Measures to prevent accidents	16
<b>2. CHAMBER DESCRIPTION</b>	<b>17</b>
2.1 Chamber overview	18
2.2 Chamber rear	19
2.3 Triangular instrument panel	20
2.4 Main power switch on the chamber rear (sizes 260 and 720)	20
2.5 Zero-voltage switching contact	20
<b>3. COMPLETENESS OF DELIVERY, TRANSPORTATION, STORAGE, AND INSTALLATION</b>	<b>21</b>
3.1 Unpacking, and checking equipment and completeness of delivery	21
3.2 Guidelines for safe lifting and transportation	22
3.3 Storage	22
3.4 Location of installation and ambient conditions	22
<b>4. INSTALLATION</b>	<b>24</b>
4.1 Electrical connection	24
4.2 Connection to an exhaust/ventilation system (optional)	25
4.3 Inserting the racks	25
<b>5. FUNCTIONAL OVERVIEW OF THE MB2 CHAMBER CONTROLLER</b>	<b>26</b>
5.1 Operating functions in normal display	27
5.2 Display views: Normal display, program display, chart-recorder display	28
5.3 Controller icons overview	29
5.4 Operating modes	31
5.5 Controller menu structure	32
5.5.1 Main menu	33
5.5.2 "Settings" submenu	34
5.5.3 "Service" submenu	34
5.6 Principle of controller entries	35
5.7 Performance during and after power failures	35
5.8 Performance when opening the door	36
<b>6. FAILSAFE FUNCTION</b>	<b>36</b>

<b>7. START UP</b>	<b>36</b>
7.1 Turning on the chamber	36
7.2 Controller settings upon start up	36
7.3 Loading	37
<b>8. SET-POINT ENTRY IN “FIXED VALUE” OPERATING MODE</b>	<b>38</b>
8.1 Set-point entry for temperature and fan speed through the “Setpoints” menu	38
8.2 Adjusting the air flap position through the “Setpoints” menu	39
8.3 Direct setpoint entry via Normal display	40
8.4 Special controller functions via operation lines	41
<b>9. TIMER PROGRAM: STOPWATCH FUNCTION</b>	<b>41</b>
9.1 Starting a timer program	42
9.1.1 Performance during program delay time	42
9.2 Cancelling a running timer program	42
9.3 Performance after the end of the program	42
<b>10. TIME PROGRAMS</b>	<b>43</b>
10.1 Starting an existing time program	43
10.1.1 Performance during program delay time	44
10.2 Stopping a running time program	44
10.2.1 Pausing a running time program	44
10.2.2 Cancelling a running time program	44
10.3 Performance after the end of the program	44
10.4 Creating a new time program	45
10.5 Program editor: program management	45
10.5.1 Deleting a time program	46
10.6 Section editor: section management	47
10.6.1 Add a new program section	48
10.6.2 Copy and insert or replace a program section	48
10.6.3 Deleting a program section	49
10.7 Value entry for a program section	50
10.7.1 Section duration	50
10.7.2 Set-point ramp and set-point step	51
10.7.3 Special controller functions via operation lines	52
10.7.4 Setpoint entry for temperature and fan speed, setting the air flap position	53
10.7.5 Tolerance ranges	54
10.7.6 Repeating one or several sections within a time program	54
10.7.7 Saving the time program	55
<b>11. WEEK PROGRAMS</b>	<b>56</b>
11.1 Starting an existing week program	56
11.2 Cancelling a running week program	56
11.3 Creating a new week program	57
11.4 Program editor: program management	58
11.4.1 Deleting a week program	59
11.5 Section editor: section management	60
11.5.1 Add a new program section	61
11.5.2 Copy and insert or replace a program section	61
11.5.3 Deleting a program section	62
11.6 Value entry for a program section	62
11.6.1 Set-point ramp and set-point step modes	62
11.6.2 Weekday	63
11.6.3 Start time	63
11.6.4 Setpoint entry for temperature and fan speed, setting the air flap position	64
11.6.5 Special controller functions via operation lines	64
<b>12. NOTIFICATION AND ALARM FUNCTIONS</b>	<b>65</b>
12.1 Notification and alarm messages overview	65
12.1.1 Notifications	65
12.1.2 Alarm messages	66

12.2	State of alarm .....	66
12.3	Resetting an alarm, list of active alarms .....	67
12.4	Tolerance range settings.....	67
12.5	Activating / deactivating the audible alarm (alarm buzzer) .....	68
<b>13.</b>	<b>OVERTEMPERATURE PROTECTION .....</b>	<b>69</b>
13.1	Overtemperature protective device class 1.....	69
13.1.1	Message and measures in the state of alarm .....	69
13.2	Overtemperature safety controller class 2 / 3.1 .....	70
13.2.1	Selecting between safety controller class 2 (temperature limiter) or class 3.1 .....	71
13.2.2	Safety controller mode.....	71
13.2.3	Setting the safety controller .....	72
13.2.4	Message and measures in the state of alarm .....	72
13.2.5	Function check .....	73
13.3	Zero-voltage relay alarm contact .....	74
<b>14.</b>	<b>USER MANAGEMENT .....</b>	<b>75</b>
14.1	Authorization levels and password protection.....	75
14.2	Log in.....	78
14.3	Log out .....	79
14.4	User change .....	79
14.5	Password assignment and password change.....	80
14.5.1	Password change .....	80
14.5.2	Deleting the password for an individual authorization level .....	82
14.5.3	New password assignment for “service” or “admin” authorization level when the password function was deactivated .....	83
14.6	Activation code .....	84
<b>15.</b>	<b>GENERAL CONTROLLER SETTINGS.....</b>	<b>85</b>
15.1	Selecting the controller’s menu language .....	85
15.2	Setting date and time .....	85
15.3	Selecting the temperature unit .....	87
15.4	Display configuration.....	87
15.4.1	Adapting the display parameters.....	87
15.4.2	Touchscreen calibration .....	88
15.5	Network and communication.....	89
15.5.1	Ethernet .....	89
15.5.1.1	Configuration .....	89
15.5.1.2	Display of the MAC address .....	90
15.5.2	E-Mail.....	90
15.6	USB menu: Data transfer via USB interface .....	91
<b>16.</b>	<b>GENERAL INFORMATION .....</b>	<b>92</b>
16.1	Service contact page.....	92
16.2	Current operating parameters .....	92
16.3	Event list.....	93
16.4	Technical chamber information .....	93
<b>17.</b>	<b>CHART RECORDER DISPLAY .....</b>	<b>94</b>
17.1	Views.....	94
17.1.1	Show and hide legend .....	94
17.1.2	Switch between legend pages.....	94
17.1.3	Show and hide specific indications.....	95
17.1.4	History display .....	95
17.2	Setting the parameters.....	98
<b>18.</b>	<b>OPTIONS.....</b>	<b>99</b>
18.1	APT-COM™ 4 Multi Management Software (option).....	99
18.2	Object temperature display with flexible Pt100 temperature sensor (option) .....	99
18.3	Object temperature control with flexible Pt100 temperature sensor (option).....	100

18.4	Analog output for temperature (option) .....	101
18.5	HEPA fresh air filter (option) .....	101
18.6	Mostly gas-tight version (option) .....	101
18.7	Inert gas connection with mostly gas-tight version (option) .....	102
<b>19.</b>	<b>CLEANING AND DECONTAMINATION .....</b>	<b>104</b>
19.1	Cleaning .....	104
19.2	Decontamination / chemical disinfection .....	106
<b>20.</b>	<b>MAINTENANCE AND SERVICE, TROUBLESHOOTING, REPAIR, TESTING .....</b>	<b>107</b>
20.1	General information, personnel qualification .....	107
20.2	Maintenance intervals, service .....	107
20.3	Simple troubleshooting .....	108
20.4	Sending the chamber back to BINDER GmbH .....	110
<b>21.</b>	<b>DISPOSAL .....</b>	<b>111</b>
21.1	Disposal of the transport packing .....	111
21.2	Decommissioning .....	111
21.3	Disposal of the chamber in the Federal Republic of Germany .....	111
21.4	Disposal of the chamber in the member states of the EU except for the Federal Republic of Germany .....	112
21.5	Disposal of the chamber in non-member states of the EU .....	114
<b>22.</b>	<b>TECHNICAL DESCRIPTION .....</b>	<b>114</b>
22.1	Factory calibration and adjustment .....	114
22.2	Definition of usable volume .....	114
22.3	Over current protection .....	115
22.4	M technical data .....	115
22.5	Equipment and options (extract) .....	117
22.6	Accessories and spare parts (extract) .....	118
22.7	Dimensions size 56 .....	119
22.8	Dimensions size 115 .....	120
22.9	Dimensions size 260 .....	121
22.10	Dimensions size 720 .....	122
<b>23.</b>	<b>CERTIFICATES AND DECLARATIONS OF CONFORMITY .....</b>	<b>123</b>
23.1	EU Declaration of Conformity .....	123
23.2	UKCA Declaration of Conformity .....	126
23.3	Certificate for the GS mark of conformity of the "Deutsche Gesetzliche Unfallversicherung e.V." (German Social Accident Insurance) DGUV .....	127
<b>24.</b>	<b>CONTAMINATION CLEARANCE CERTIFICATE .....</b>	<b>129</b>
24.1	For chambers located outside the USA and Canada .....	129
24.2	For chambers located in the USA and Canada .....	132

**Dear customer,**

For the correct operation of the chambers, it is important that you read this operating manual completely and carefully and observe all instructions as indicated. Failure to read, understand and follow the instructions may result in personal injury. It can also lead to damage to the chamber and/or poor equipment performance

## 1. Safety

### 1.1 Personnel Qualification



The chamber must only be installed, tested, and started up by personnel qualified for assembly, startup, and operation of the chamber. Qualified personnel are persons whose professional education, knowledge, experience and knowledge of relevant standards allow them to assess, carry out, and identify any potential hazards in the work assigned to them. They must have been trained and instructed, and be authorized, to work on the chamber.

The chamber should only be operated by laboratory personnel especially trained for this purpose and familiar with all precautionary measures required for working in a laboratory. Observe the national regulations on minimum age of laboratory personnel.

### 1.2 Operating manual

This operating manual is part of the components of delivery. Always keep it handy for reference in the vicinity of the chamber. If selling the unit, hand over the operating manual to the purchaser.

To avoid injuries and damage observe the safety instructions of the operating manual. Failure to follow instructions and safety precautions can lead to significant risks.

	 <b>DANGER</b>
<p><b>Dangers due to failure to observe the instructions and safety precautions. Serious injuries and chamber damage. Risk of death.</b></p> <ul style="list-style-type: none"> <li>➤ Observe the safety instructions in this Operating Manual.</li> <li>➤ Follow the operating procedures in this Operating Manual.</li> <li>➤ Carefully read the complete operating instructions of the chamber prior to installing and using the chamber.</li> <li>➤ Keep the operating manual for future reference</li> </ul>	

	<p>Make sure that all persons who use the chamber and its associated work equipment have read and understood the Operating Manual.</p>
---	--

This Operating Manual is supplemented and updated as needed. Always use the most recent version of the Operating Manual. When in doubt, call the BINDER Service Hotline for information on the up-to-date-ness and validity of this Operating Manual.

### 1.3 Legal considerations

This operating manual is for informational purposes only. It contains information for correct and safe installing, start-up, operation, decommissioning, cleaning and maintenance of the product. Note: the contents and the product described are subject to change without notice.

Understanding and observing the instructions in this operating manual are prerequisites for hazard-free use and safety during operation and maintenance. Images are to provide basic understanding. They may deviate from the actual version of the chamber. The actual scope of delivery can, due to optional or special design, or due to recent technical changes, deviate from the information and illustrations in these instructions this operating manual. In no event shall BINDER be held liable for any damages, direct or incidental arising out of or related to the use of this manual.

This operating manual cannot cover all conceivable applications. If you would like additional information, or if special problems arise that are not sufficiently addressed in this manual, please ask your dealer or contact us directly, e.g. by phone at the number located on page one of this manual

Furthermore, we emphasize that the contents of this operating manual are not part of an earlier or existing agreement, description, or legal relationship, nor do they modify such a relationship. All obligations on the part of BINDER derive from the respective purchase contract, which also contains the entire and exclusively valid statement of warranty administration and the general terms and conditions, as well as the legal regulations valid at the time the contract is concluded. The statements in this manual neither augment nor restrict the contractual warranty provisions.

### 1.3.1 Intellectual property

**This operating manual is protected by copyright. Any unauthorized copying or disclosure to third parties is strictly prohibited. We reserve the right to take legal action and, if necessary, to assert claims for damages in the event of infringement.**

**Trademark Information:** All BINDER trademarks relating to products or service, as well as trade names, logos and product names used on the website, products and documents of BINDER company are trademarks or registered trademarks of BINDER company (including BINDER GmbH, BINDER Inc.) in the U.S. and other countries and communities of states. This includes word marks, position marks, word/figurative marks, design configurations, figurative marks, and design patents.

**Patent Information:** BINDER products, categories of products, and accessories may be covered by one or more patents and/or utility models in the U.S. and other countries and communities of states. This information is provided to satisfy the virtual patent marking provisions of various jurisdictions, in particular it is intended to serve as notice under 35 U.S.C. § 287(a). Products and services listed on the BINDER website may be sold individually or as part of a combination product. Additional patent applications may also be pending in the U.S. and other countries and communities of states.

Please visit [www.binder-world.com](http://www.binder-world.com) for more information.

## 1.4 Structure of the safety instructions

In this operating manual, the following safety definitions and symbols indicate dangerous situations following the harmonization of ISO 3864-2 and ANSI Z535.6.

### 1.4.1 Signal word panel

Depending on the probability of serious consequences, potential dangers are identified with a signal word, the corresponding safety color, and if appropriate, the safety alert symbol.

 <b>DANGER</b>
Indicates an imminently hazardous situation that, if not avoided, will result in death or serious (irreversible) injury.

 <b>WARNING</b>
Indicates a potentially hazardous situation which, if not avoided, could result in death or serious (irreversible) injury

 <b>CAUTION</b>
Indicates a potentially hazardous situation which, if not avoided, may result in moderate or minor (reversible) injury

## NOTICE

Indicates a potentially hazardous situation which, if not avoided, may result in damage to the product and/or its functions or of a property in its proximity.

### 1.4.2 Safety alert symbol



Use of the safety alert symbol indicates a **risk of injury**.

Observe all measures that are marked with the safety alert symbol in order to avoid death or injury.

### 1.4.3 Pictograms

Warning signs			
Electrical hazard	Hot surface	Explosive atmosphere	Stability hazard
Lifting hazard	Risk of corrosion and / or chemical burns	Suffocation hazard	Harmful substances
Biohazard	Pollution Hazard		
Mandatory action signs			
Mandatory regulation	Read operating instructions	Disconnect the power plug	Lift with several persons
Lift with mechanical assistance	Environment protection	Wear protective gloves	Wear safety goggles
Prohibition signs			
Do NOT touch	Do NOT spray with water		



**Information** to be observed in order to ensure optimum function of the product.



### 1.4.4 Word message panel structure

**Type / cause of hazard.**



**Possible consequences.**

- ⊘ Instruction how to avoid the hazard: prohibition.
- Instruction how to avoid the hazard: mandatory action.

Observe all other notes and information not necessarily emphasized in the same way, in order to avoid disruptions that could result in direct or indirect injury or property damage.

### 1.5 Localization / position of safety labels on the chamber

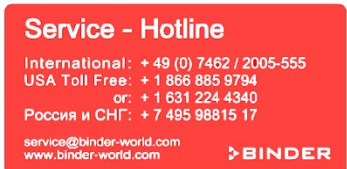
The following labels are located on the chamber:

Pictograms (Warning signs)	Service label
 <p>Hot surface</p> <ul style="list-style-type: none"> <li>• Outer chamber door</li> <li>• On chamber rear next to the exhaust duct</li> </ul>	 <p><b>Service - Hotline</b>            International: + 49 (0) 7462 / 2005-555            USA Toll Free: + 1 866 885 9794            or: + 1 631 224 4340            Россия и СНГ: + 7 495 98815 17  <small>service@binder-world.com            www.binder-world.com</small> </p>

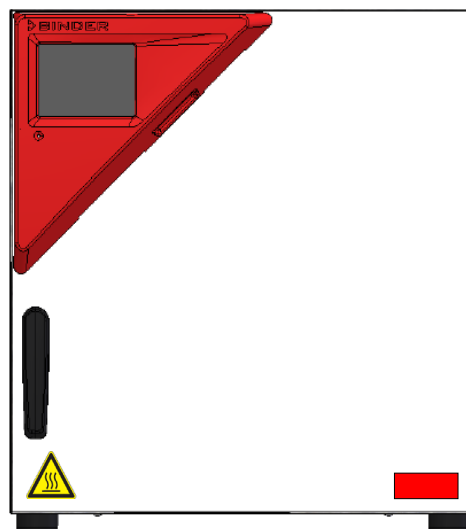

Figure 1: Position of labels on the chamber front (example: M 56)



Keep safety labels complete and legible.

Replace safety labels that are no longer legible. Contact BINDER Service for these replacements.

## 1.6 Type plate

The type plate is located on the left-hand side of the chamber, bottom right-hand.





Figure 2: Type plate (example M 115 regular chamber)

### Indications of the type plate (example)

Indication		Information
BINDER		Manufacturer: BINDER GmbH
M 115		Model designation
Drying and heating oven		Chamber name: Drying and heating oven
Serial No.	000000000000	Serial No of the chamber
Built	2024	Year of construction
Nominal temperature	300 °C 572 °F	Nominal temperature
IP protection	20	IP type of protection acc. to EN 60529
Temp. safety device	DIN 12880	Temperature safety device acc. to standard DIN 12880
Class	2/3.1	Class of temperature safety device (selectable)
Art. No.	9010-0372	Art. no. of the chamber
Project No.	---	Optional: Special application acc. to project no.
2,40 kW		Nominal power
10,5 A		Nominal current
230 V / 50 Hz		Nominal voltage ± 10% at the indicated power frequency
230 V / 60 Hz		
1 N ~		Current type

### Symbols on the type plate

Symbol	Information
	CE conformity marking
	Electrical and electronic equipment manufactured / placed on the market in the EU after 13 August 2005 and be disposed of in separate collection according to Directive 2012/19/EU on waste electrical and electronic equipment (WEEE).
	GS mark of conformity of the "Deutsche Gesetzliche Unfallversicherung e.V. (DGUV), Prüf- und Zertifizierungsstelle Nahrungsmittel und Verpackung im DGUV Test" (German Social Accident Insurance (DGUV), Testing and Certification Body for Foodstuffs and Packaging Industry in DGUV Test).

## 1.7 UKCA Label

The sticker with UKCA Authorised Representative details sticks next to the type plate to the left side of the chamber, bottom right-hand.



Figure 3: UKCA Label

### Symbol on the sticker

Symbol	Information
	UKCA conformity marking

## 1.8 General safety instructions on installing and operating the chambers



With regard to operating the chambers and to the installation location, please observe the local and national regulations relevant for your country (for Germany: DGUV guidelines 213-850 on safe working in laboratories, issued by the employers' liability insurance association).

BINDER GmbH is only responsible for the safety features of the chamber provided skilled electricians or qualified personnel authorized by BINDER perform all maintenance and repair, and if components relating to chamber safety are replaced in the event of failure with original spare parts.



To operate the chamber, use only original BINDER accessories or accessories from third-party suppliers authorized by BINDER. The user is responsible for any risk caused by using unauthorized accessories.

<b>NOTICE</b>	
	<p><b>Danger of overheating due to lack of ventilation.</b>  <b>Damage to the chamber.</b></p> <ul style="list-style-type: none"> <li>⊘ Do NOT install the chamber in unventilated recesses.</li> <li>➤ Ensure sufficient ventilation for dispersal of the heat.</li> <li>➤ Observe the prescribed minimum distances when installing the chamber (chap. 3.4)</li> </ul>

Do not install or operate the chambers in hazardous locations.



<b>DANGER</b>	
	<p style="text-align: center;"></p> <p><b>Danger of explosion due to combustible dusts or explosive mixtures in the vicinity of the chamber.</b>  <b>Serious injury or death from burns and / or explosion pressure.</b></p> <ul style="list-style-type: none"> <li>⊘ Do NOT operate the chamber in potentially explosive areas.</li> <li>➤ KEEP combustible dust or air-solvent mixtures AWAY from the chamber.</li> </ul>

The chambers do not dispose of any measures of explosion protection.

	 <b>DANGER</b>
	<p><b>Danger of explosion due to introduction of flammable or explosive substances in the chamber.</b></p> <p><b>Serious injury or death from burns and / or explosion pressure.</b></p> <ul style="list-style-type: none"> <li>∅ Do NOT introduce any substance into the chamber which is combustible or explosive at working temperature.</li> <li>∅ Do NOT introduce any combustible dust or air-solvent mixture in the inner chamber.</li> </ul>



Any solvent contained in the charging material must not be explosive or inflammable. I.e., irrespective of the solvent concentration in the steam room, NO explosive mixture with air must form. The temperature inside the chamber must lie below the flash point or below the sublimation point of the charging material. Familiarize yourself with the physical and chemical properties of the charging material, as well as the contained moisture constituent and its behavior with the addition of heat energy.

Familiarize yourself with any potential health risks caused by the charging material, the contained moisture constituent or by reaction products that may arise during the temperature process. Take adequate measures to exclude such risks prior to putting the chamber into operation.

	 <b>DANGER</b>
	<p><b>Electrical hazard by water entering the chamber.</b></p> <p><b>Deadly electric shock.</b></p> <ul style="list-style-type: none"> <li>∅ The chamber must NOT become wet during operation, cleaning, or maintenance.</li> <li>∅ Do NOT install the chamber in damp areas or in puddles.</li> <li>➤ Set up the chamber in a splash-proof manner.</li> </ul>

The chambers were produced in accordance with VDE regulations and were routinely tested in accordance to VDE 0411-1 (IEC 61010-1).

During and shortly after operation, the temperature of the inner surfaces almost equals the set-point. The inner chamber, exhaust duct, the door gaskets, and the area of the access ports (option), will become hot during operation.

	 <b>CAUTION</b>
	<p><b>Danger of burning by touching hot chamber parts during or after operation.</b></p> <p><b>Burns.</b></p> <ul style="list-style-type: none"> <li>∅ Do NOT touch the inner surfaces, exhaust duct, access ports (option), door gaskets, or the charging material during operation.</li> <li>∅ Do NOT place the power cable over the door gap when the chamber is hot after operation.</li> </ul>

## 1.9 Intended use



Observing the instructions in this operating manual and conducting regular maintenance work (chap. 20.2) is part of the intended use.

**Any use of the chambers that does not comply with the requirements specified in this Operating Manual shall be considered improper use.**

**Other applications than those described in this chapter are not approved.**

### Use

Drying and heating ovens with forced convection and advanced program functions M are suitable for drying and heat treatment of solid or pulverized charging material, as well as bulk material, using the supply of heat. They can be used for drying purposes but are specially designed for solving all the problems which occur during material and ageing tests. The chambers are suitable for harmless materials.



DO NOT use the device for drying processes that release so large amounts of water vapor that condensation occurs.

### Requirements for the chamber load



Any solvent must not be explosive or flammable. A mixture of any component of the charging material with air must NOT be explosive. The operating temperature must lie below the flash point or below the sublimation point of the charging material. Any component of the charging material must NOT be able to release toxic gases.

The loading material shall not contain any corrosive ingredients that may damage the machine components made of stainless steel, aluminum, and copper. Such ingredients include in particular acids and halides. Any corrosive damage caused by such ingredients is excluded from liability by BINDER GmbH.

The chamber does not dispose of any measures of explosion protection.

 	 <b>DANGER</b>
	<p><b>Explosion or implosion hazard and danger of poisoning through the introduction of unsuitable loading material.</b></p> <p><b>Poisoning. Serious injury or death from burns and / or explosion pressure.</b></p> <ul style="list-style-type: none"> <li>⊘ Do NOT introduce any substance combustible or explosive at working temperature into the chamber, in particular no energy sources such as batteries or lithium-ion batteries.</li> <li>⊘ NO explosive dust or air-solvent mixture in the inner chamber.</li> <li>⊘ Do NOT introduce any substance which could lead to release of toxic gases.</li> </ul>

Contamination of the chamber by toxic, infectious or radioactive substances must be prevented

 	 <b>WARNING</b>
	<p><b>Danger of intoxication and infection through contamination of the chamber with toxic, infectious or radioactive substances.</b></p> <p><b>Damages to health.</b></p> <ul style="list-style-type: none"> <li>➤ Protect the interior of the chamber from contamination by toxic, infectious or radioactive substances.</li> <li>➤ Take suitable protective measures when introducing and removing toxic, infectious or radioactive material</li> </ul>

In case of foreseeable use of the chamber there is no risk for the user through the integration of the chamber into systems or by special environmental or operating conditions in the sense of EN 61010-1. For this, the intended use of the chamber and all its connections must be observed.

Connect only external devices to the chamber interfaces Ethernet and USB which are compliant with the standards EN 61010-1:2010 or EN 60950-1:2006 mod.

## Medical devices

The chambers are not classified as medical devices as defined by Regulation (EU) No 2017/745.



Due to the special demands of the Medical Products legislation, these chambers are not qualified to perform sterilization of medical devices as defined by Regulation (EU) No 2017/745.

## Personnel Requirements

Only trained personnel with knowledge of the Operating Manual can set up and install the chamber, start it up, operate, clean, and take it out of operation. Service and repairs call for further technical requirements (e.g. electrical know-how), as well as knowledge of the service manual.

## Installation site requirements

The chambers are designed for setting up inside a building (indoor use).

The requirements described in the Operating Manual for installation site and ambient conditions (chap. 3.4) must be met.

## 1.10 Foreseeable Misuse

Other applications than those described in chap. 1.9 are not approved.

This expressly includes the following misuses (the list is not exhaustive), which pose risks despite the inherently safe construction and existing technical safety equipment:

- Non-observance of Operating Manual
- Non-observance of information and warnings on the chamber (e.g. control unit messages, safety identifiers, warning signals)
- Installation, startup, operation, maintenance and repair by untrained, insufficiently qualified, or unauthorized personnel
- Missed or delayed maintenance and testing
- Non-observance of traces of wear and tear
- Insertion of materials excluded or not permitted by this Operating Manual.
- Non-compliance with the admissible parameters for processing the respective material.
- Installation, testing, service or repair in the presence of solvents
- Installation of replacement parts and use of accessories and operating resources not specified and authorized by the manufacturer
- Installation, startup, operation, maintenance or repair of the chamber in absence of operating instructions
- Bypassing or changing protective systems, operation of the chamber without the designated protective systems
- Non-observance of messages regarding cleaning and disinfection of the chamber.
- Spilling water or cleaning agent on the chamber, water penetrating into the chamber during operation, cleaning or maintenance
- Cleaning activity while the chamber is turned on
- Operation of the chamber with a damaged housing or damaged power cord
- Continued operation of the chamber during an obvious malfunction
- Insertion of objects, particularly metallic objects, in louvers or other openings or slots on the chamber
- Human error (e.g. insufficient experience, qualification, stress, exhaustion, laziness)

To prevent these and other risks from incorrect operation, the operator shall issue operating instructions. Standard operating procedures (SOPs) are recommended.

## 1.11 Residual Risks

The unavoidable design features of a chamber, as well as its proper field of application, can also pose risks, even during correct operation. These residual risks include hazards which, despite the inherently safe design, existing technical protective equipment, safety precautions and supplementary protective measures, cannot be ruled out.

Messages on the chamber and in the Operating Manual warn of residual risks. The consequences of these residual risks and the measures required to prevent them are listed in the Operating Manual. Moreover, the operator must take measures to minimize hazards from unavoidable residual risks. This includes, in particular, issuing operating instructions.

The following list summarizes the hazards against which this Operating Manual and the Service Manual warn, and specifies protective measures at the appropriate spots:

### Unpacking, Transport, Installation

- Sliding or tilting the chamber
- Setup of the chamber in unauthorized areas
- Installation of a damaged chamber
- Installation of a chamber with damaged power cord
- Inappropriate site of installation
- Missing protective conductor connection

### Normal operation

- Assembly errors
- Contact with hot surfaces on the housing
- Contact with hot surfaces in the interior and inside of doors
- Emission of non-ionizing radiation from electrical operating resources
- Contact with live parts in normal state
- Inappropriate handling of inert gas (option)

### Cleaning and Decontamination

- Penetration of water into the chamber
- Inappropriate cleaning and decontamination agents
- Enclosure of persons in the interior

### Malfunction and Damage

- Continued operation of the chamber during an obvious malfunction or outage of the heating system
- Contact with live parts during error status
- Operation of a unit with damaged power cord

### Maintenance

- Maintenance work on live parts.
- Execution of maintenance work by untrained/insufficiently qualified personnel
- Electrical safety analysis during annual maintenance not performed

### Trouble-shooting and Repairs

- Non-observance of warning messages in the Service Manual
- Trouble-shooting of live parts without specified safety measures
- Absence of a plausibility check to rule out erroneous inscription of electrical components
- Performance of repair work by untrained/insufficiently qualified personnel

- Inappropriate repairs which do not meet the quality standard specified by BINDER
- Use of replacement parts other than BINDER original replacement parts
- Electrical safety analysis not performed after repairs

## 1.12 Operating instructions

Depending on the application and location of the chamber, the operator of the chamber must provide the relevant information for safe operation of the chamber in a set of operating instructions.



Keep these operating instructions with the chamber at all times in a place where they are clearly visible. They must be comprehensible and written in the language of the employees.

## 1.13 Measures to prevent accidents

The operator of the chamber must observe the local and national regulations (for Germany: the rule “Operation of work equipment. Operation of refrigeration systems, heat pumps and refrigeration equipment”, GUV-R 500 chap. 2.35) and take precautions to prevent accidents.

The manufacturer took the following measures to prevent ignition and explosions:

- **Indications on the type plate**  
See operating manual chap. 1.6.
- **Operating manual**  
An operating manual is available for each chamber.
- **Overtemperature monitoring**  
The chamber is equipped with a temperature display, which can be read from outside.  
The chamber is equipped with an additional safety controller (temperature safety device class 2 or 3.1 (adjustable) acc. to DIN 12880:2007). Visual and audible (buzzer) signals indicate temperature exceeding.
- **Safety, measurement, and control equipment**  
The safety, measuring, and control equipment is easily accessible.
- **Electrostatic charge**  
The interior parts are grounded.
- **Non-ionizing radiation**  
Non-ionizing radiation is not intentionally produced, but released only for technical reasons by electrical equipment (e.g. electric motors, power cables, solenoids). The machine has no permanent magnets. If persons with active implants (e.g. pacemakers, defibrillators) keep a safe distance (distance of field source to implant) of 30 cm, an influence of these implants can be excluded with high probability.
- **Protection against touchable surfaces**  
Tested according to EN ISO 13732-1:2008.
- **Floors**  
See operating manual chap. 3.4 for correct installation
- **Cleaning**  
See operating manual chap. 19.
- **Examinations**  
The chamber has been inspected by the “Deutsche Gesetzliche Unfallversicherung e.V. (DGUV) (German Social Accident Insurance (DGUV))” (German Social Accident Insurance (DGUV), Testing and Certification Body for Foodstuffs and Packaging Industry in DGUV Test) and bears the GS mark.



## 2. Chamber description

The drying and heating ovens with forced convection and advanced program functions M are specially developed precision warming chamber with high capacity. They are equipped with a multifunctional micro-processor touch display controller with a digital display accurate to one-tenth of a degree. With their comprehensive program control functions, they allow the high precision performance of temperature cycles with fast heating-up phases.

All chambers are heated electrically and ventilated by fan-assisted, forced-air circulation.

The concept of air conduction guarantees high level of spatial and time-based temperature precision, thanks to the direct and distributed air circulation into the interior. The powerful fan supports exact attainment and maintenance of the desired temperature accuracy.

The chambers are regularly equipped with an overtemperature safety device class 1 acc. to DIN12880:2007 and with an overtemperature safety controller (selectable between overtemperature temperature safety device class 2 or class 3.1 acc. to DIN12880:2007), see chap. 13).

The chambers are equipped with the "FailSafe" function, a second temperature sensor is used for mutual monitoring and takes over the function in the event of an error (chap. 6).

**Material:** The inner chamber and the inside of the doors are made of stainless steel V2A (German material no. 1.4301, US equivalent AISI 304 and material no. 1.4016, US equivalent AISI 430). When operating the chambers at temperatures above 150 °C / 302 °F, the impact of the oxygen in the air may cause discoloration of the metallic surfaces (yellowish-brown or blue) by natural oxidation processes. These colorations are harmless and will in no way impair the function or quality of the chamber. The housing is RAL 7035 powder-coated. All corners and edges are also completely coated.

**Controller:** The efficient program controller is equipped with a multitude of operating functions, in addition to recorder and alarm functions. Programming of test cycles is easily accomplished via the modern MB2 touch screen controller and is also possible directly with a computer via Intranet in connection with the APT-COM™ 4 Multi Management Software (option, chap. 18.1). The chamber comes equipped with an Ethernet serial interface for computer communication. In addition, the BINDER APT-COM™ 4 Multi Management Software permits networking up to 100 chambers and connecting them to a PC for controlling and programming, as well as recording and representing temperature data. For further options, see chap. 18.

All chamber functions are easy and comfortable to use thanks to their clear arrangement. Major features are easy cleaning of all chamber parts and avoidance of undesired contamination.

The chambers sizes 56 and 115 are equipped with an on/off switch on the bottom right-hand side of the door. The chambers sizes 260 and 720 have a main power switch on the chamber rear.

The chambers are regularly equipped with a zero-voltage relay alarm contact and a zero-voltage switching contact. As optional equipment they are available with analog output, access ports with silicone plugs, HEPA air filter, inert gas connection with mostly gas-tight design, object temperature display and object temperature control.

The chambers are regularly equipped with an Ethernet interface for computer communication, e.g. via the APT-COM™ 4 Multi Management Software (option, chap. 18.1) and with a USB interface to read out the measured values in real time.

The models size 720 are equipped with four castors. Both front castors can be locked by brakes.

Temperature ranges see technical data (chap. 22.4).

## 2.1 Chamber overview

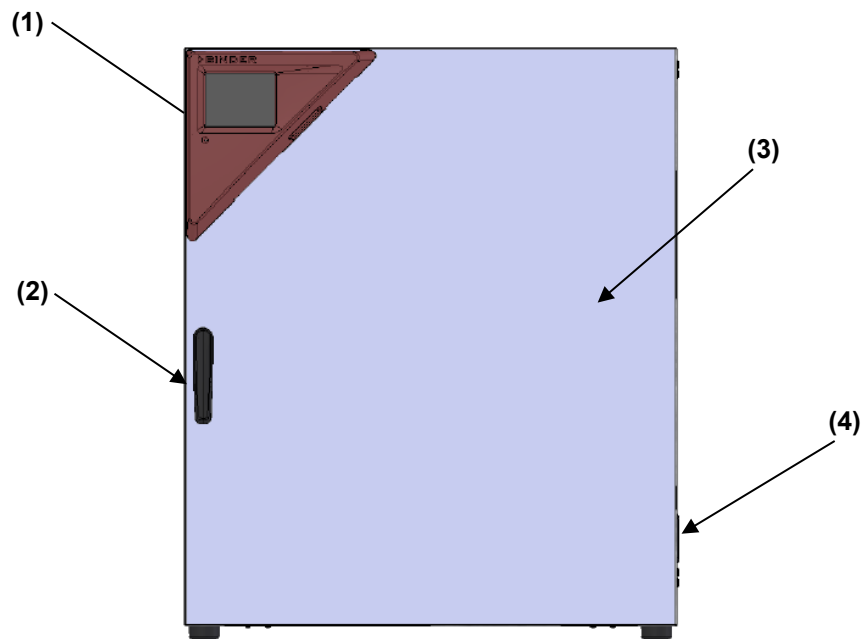

Figure 4: Overview, closed chamber with single door



Figure 5: Overview, open chamber with single door

- (1) Triangular instrument panel with MB2 controller and USB interface
- (2) Door handle
- (3) Outer door
- (4) On/Off switch (up to size 115), with M 260 cover without function
- (5) Rack

## 2.2 Chamber rear

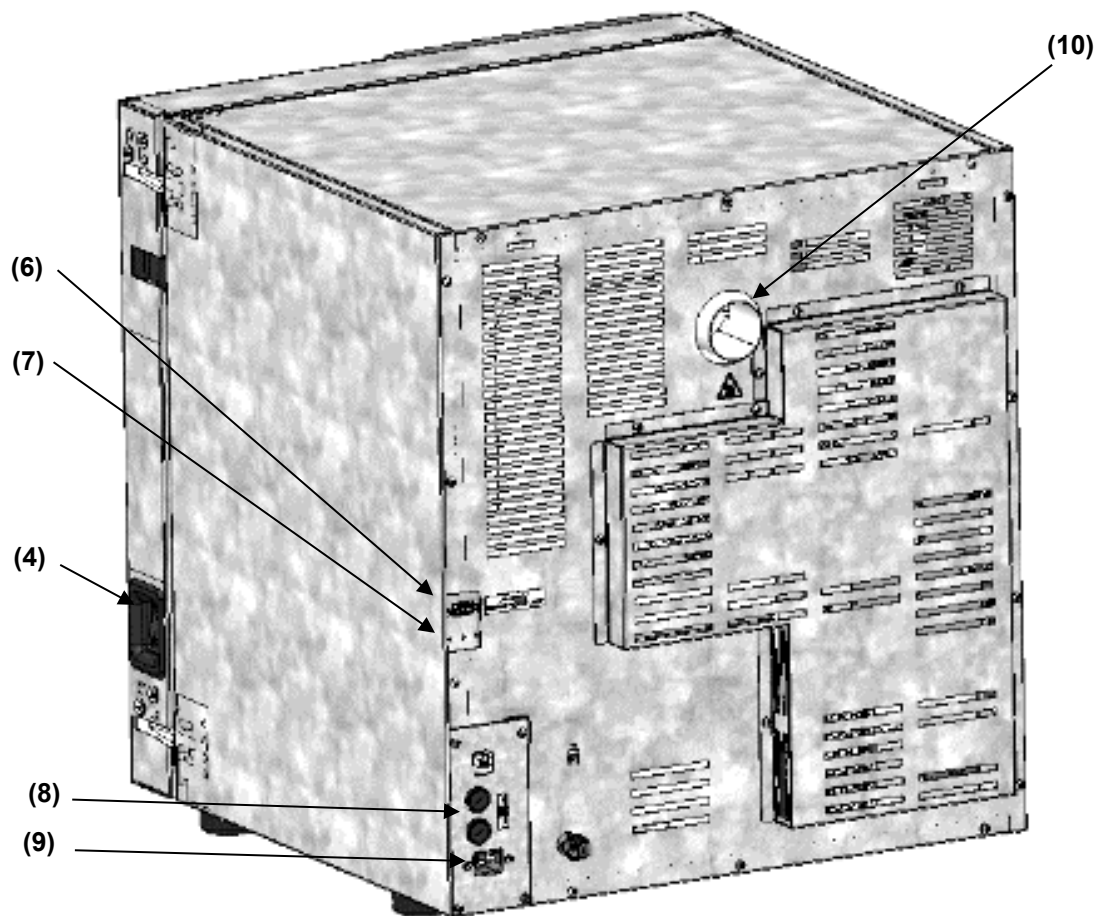

Figure 6: Overview, chamber with single door

- (4) On/Off switch (up to size 115)
- (6) SUB-D socket "ALARM / SWITCH CONTACT" for zero-voltage relay alarm contact and zero-voltage switching contact
- (7) SUB-D socket "ANALOG OUTPUT" (option) for optional analog output
- (8) Miniature fuses 250 V AC (T) (up to size 115):  
2x 10 A for M 56 und 2x 12,5A for M 115
- (9) Connection for IEC connector plug (up to size 115) 230 V AC
- (10) Exhaust duct

## 2.3 Triangular instrument panel

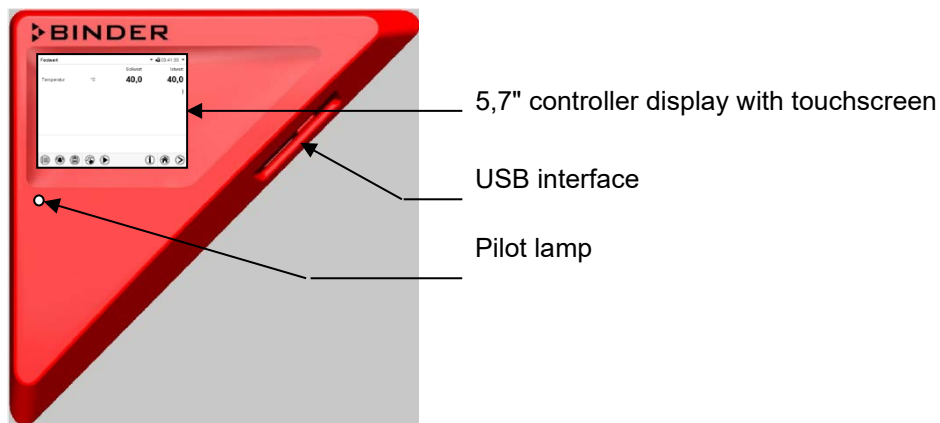

Figure 7: Instrument panel with MB2 program controller and USB interface

## 2.4 Main power switch on the chamber rear (sizes 260 and 720)

The chambers sizes 260 and 720 are equipped with a main power (11) switch located on the chamber rear. This rear power switch allows completely switching off the chamber (de-energized condition). The switch is intended for service and is intended to be used as a power disconnection device in the event of danger.



Figure 8: Main power switch (11) on the M 260 and 720 chamber rear

## 2.5 Zero-voltage switching contact

The chambers are regularly equipped with a zero-voltage switching contact.

The SUB-D socket "ALARM / SWITCH CONTACT" (6) serves not only for collective alarm output via zero-voltage alarm contact (chap. 13.3) but also for controlling a switching contact via the program controller, which serve to switch any device connected to the zero-voltage relay output. They are controlled in the "Functions on/off" menu of the chamber controller (chap. 8.4, 10.7.3, 11.6.5).

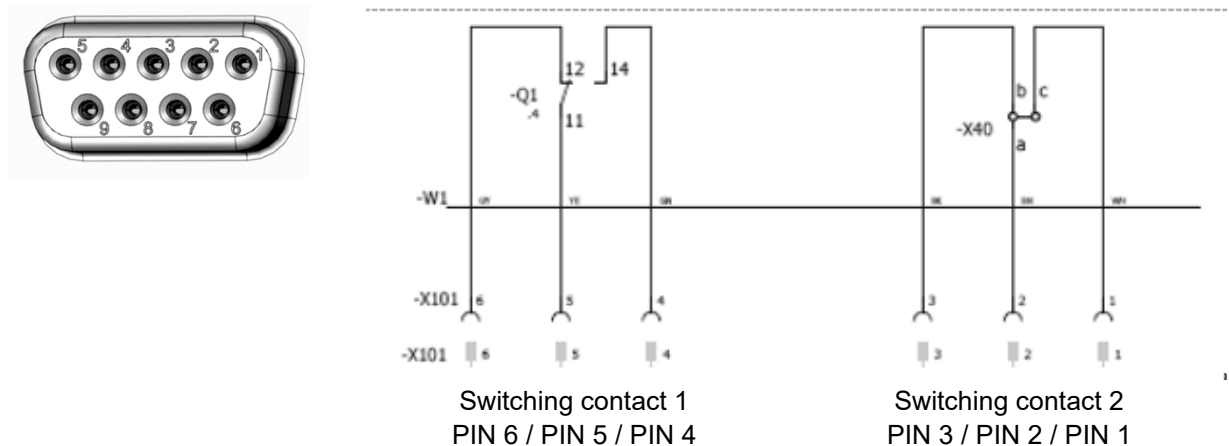



Figure 9: Pin allocation of the SUB-D socket „ALARM / SWITCH CONTACT“ (6) for zero-voltage switching contact

Maximum loading capacity of the switching contacts: 24V AC/DC – 2.5 A

	 <b>DANGER</b>
	<p><b>Electrical hazard through overload of contacts.</b>  <b>Deadly electric shock. Damage to the switching contacts and connection socket.</b></p> <ul style="list-style-type: none"> <li>Ø Do NOT exceed the maximum switching load of 24V AC/DC – 2.5A.</li> <li>Ø Do NOT connect any devices with a higher loading capacity.</li> </ul>





### 3. Completeness of delivery, transportation, storage, and installation

#### 3.1 Unpacking, and checking equipment and completeness of delivery

After unpacking, please check the chamber and its optional accessories, if any, based on the delivery receipt for completeness and for transportation damage. Inform the carrier immediately if transportation damage has occurred.

The final tests of the manufacturer may have caused traces of the racks on the inner surfaces. This has no impact on the function and performance of the chamber.

Please remove any transportation protection devices and adhesives in/on the chamber and on the doors and take out the operating manuals and accessory equipment.

   	 <b>CAUTION</b>
	<p><b>Risk of injury and damages by lifting heavy loads and by sliding or tilting of the chamber due to improper lifting.</b>  <b>Injuries, damage to the chamber.</b></p> <ul style="list-style-type: none"> <li>Ø Do NOT lift or transport the chamber using the door handle or the door.</li> <li>Ø Do NOT lift chambers size 720 by hand</li> <li>➤ Lift the chamber size 56 and 115 from the pallet at its four lower corners with the aid of 2 people, chamber size 260 with the aid of 4 people.</li> <li>➤ Lift chambers size 720 from the pallet using technical devices (fork lifter). Set the fork lifter only from the rear in the middle of the chamber. Make sure to place all the lateral supports of the chamber on the forks.</li> </ul>

If you need to return the chamber, please use the original packing and observe the guidelines for safe lifting and transportation (chap. 3.2).

For disposal of the transport packing, see chap. 21.1.



#### Note on second-hand chambers (Ex-Demo-Units):

Second-hand chambers are chambers that have been used for a short time for tests or exhibitions. They are thoroughly tested before resale. BINDER ensures that the chamber is technically sound and will work flawlessly.

Second-hand chambers are marked with a sticker on the chamber door. Please remove the sticker before commissioning the chamber.

### 3.2 Guidelines for safe lifting and transportation

The front castors of chambers size 720 can be blocked by brakes. Please move the chambers with castors only when empty and on an even surface, otherwise the castors may be damaged. After operation, please observe the guidelines for temporarily decommissioning the chamber (chap. 21.2).

	 <b>CAUTION</b>
<p><b>Risk of injury and damages by lifting heavy loads and by sliding or tilting of the chamber due to improper transportation.</b></p> <p><b>Injuries, damage to the chamber.</b></p> <ul style="list-style-type: none"> <li>➤ Transport the chamber only in its original packaging.</li> <li>➤ Secure the chamber with transport straps for transport.</li> <li>⊘ Do NOT lift or transport the chamber using the door handle or the door.</li> <li>⊘ Do NOT lift chambers size 720 by hand</li> <li>➤ Lift chamber size 56 and 115 at its four lower corners with the aid of 2 people, chamber size 260 with the aid of 4 people, and place it on a transport pallet with wheels. Push the pallet to the desired site and then lift the chamber from the pallet at its four lower corners.</li> <li>➤ Place chamber size 720 using technical devices (fork lifter) on the transport pallet. Set the fork lifter only from the rear in the middle of the chamber. Make sure to place all the lateral supports of the chamber on the forks.</li> <li>➤ Transport chamber size 720 ONLY with the original transport pallet. Set the fork lifter only to the pallet. Without the pallet the chamber is in imminent danger of overturning!</li> </ul>	

- Permissible ambient temperature range during transport: -10 °C to +60 °C / 14 °F to 140 °F.

You can order transport packing and pallets for transportation purposes from BINDER Service.

### 3.3 Storage

Intermediate storage of the chamber is possible in a closed and dry room. Observe the guidelines for temporary decommissioning (chap. 21.2).

- Permissible ambient temperature range during storage: -10 °C to +60 °C / 14 °F to 140 °F.
- Permissible ambient humidity: max. 70 % r.H., non-condensing



When after storage in a cold location you transfer the chamber to its warmer installation site, condensation may form. Before start-up, wait at least one hour until the chamber has attained ambient temperature and is completely dry.

### 3.4 Location of installation and ambient conditions

Set up the chamber on an even and non-flammable surface, free from vibration and in a well-ventilated, dry location and align it using a spirit level. The site of installation must be capable of supporting the chamber's weight (see technical data, chap. 22.4). The chambers are designed for setting up inside a building (indoor use).

	<b>NOTICE</b>
<p><b>Danger of overheating due to lack of ventilation.</b></p> <p><b>Damage to the chamber.</b></p> <ul style="list-style-type: none"> <li>⊘ Do NOT install the chamber in unventilated recesses.</li> <li>➤ Ensure sufficient ventilation for dispersal of the heat.</li> <li>➤ Observe the prescribed minimum distances when installing the chamber.</li> </ul>	

Do not install or operate the chamber in potentially explosive areas.

	 <b>DANGER</b>
	<p><b>Danger of explosion due to combustible dusts or explosive mixtures in the vicinity of the chamber.</b></p> <p><b>Serious injury or death from burns and / or explosion pressure.</b></p> <ul style="list-style-type: none"> <li>⊘ Do NOT operate the chamber in potentially explosive areas.</li> <li>➤ KEEP explosive dust or air-solvent mixtures AWAY from the vicinity of the chamber.</li> </ul>

### Ambient conditions

- Permissible ambient temperature range during operation: +18 °C / 64.4 °F to +32 °C / 89.6 °F. At elevated ambient temperature values, fluctuations in temperature can occur.

	<p>The ambient temperature should not be substantially higher than the indicated ambient temperature of +22 °C +/- 3 °C / 77 °F to which the specified technical data relate. For other ambient conditions, deviations from the indicated data are possible.</p>
---	--

- Permissible ambient humidity: 70 % r.H. max., non-condensing.
- Installation height: max. 2000 m / 6562 ft. above sea level.

### Minimum distances

When placing several chambers of the same size side by side, maintain a minimum distance of 250 mm / 9.84 in between each chamber. Wall distances: rear 160 mm / 6.30 in, sides 100 mm / 3.94 in. Spacing above the chamber of at least 100 mm / 3.94 in must also be accounted for.

- When placing several chambers of the same size side by side, maintain a minimum distance of 250 mm / 9.84 in between each chamber.
- Wall distances: rear 160 mm / 6.30 in, sides 100 mm / 3.94 in.
- Spacing above the chamber of at least 100 mm / 3.9 in must also be accounted for.

### Stacking

Two devices up to size 115 can be stacked on top of each other. For this purpose place rubber pads Art. no. 8012-0001 under all feet of the upper chamber to prevent the device from slipping.

	<b>NOTICE</b>
	<p><b>Risk of damages by sliding or tilting of the upper chamber.</b></p> <p><b>Damage to the chambers.</b></p> <ul style="list-style-type: none"> <li>➤ When stacking, place rubber pads under all feet of the upper chamber.</li> <li>➤ Stack only chambers of the same size.</li> </ul>

Chambers sizes 260 and 720 must NOT be stacked.

	<b>NOTICE</b>
	<p><b>Danger by stacking.</b></p> <p><b>Damage to the chambers.</b></p> <ul style="list-style-type: none"> <li>⊘ Do NOT place chambers sizes 260 or 720 on top of each other.</li> </ul>

### Other requirements

To completely separate the chamber from the power supply, you must disconnect the power plug. Install the chamber in a way that the power plug is easily accessible and can be easily pulled in case of danger. Do not conduct the power cable above the exhaust duct.



## 4. Installation

### 4.1 Electrical connection

The chambers are supplied ready for connection. The chambers M 260 and 720 come with a fixed power connection cable of at least 1800 mm / 70.87 in in length. The other chambers come with an IEC connector plug.

Model	Power plug / power cable	Nominal voltage +/- 10% at the indicated power frequency	Current type	Chamber fuse
M 56	Grounded plug	230 V at 50 Hz 230 V at 60 Hz	1N~	6,3 A
M 115	Grounded plug	230 V at 50 Hz 230 V at 60 Hz	1N~	12,5 A
M 260	Grounded plug	400 V at 50 Hz 400 V at 60 Hz	3N~	---
M 720	Grounded plug	400 V at 50 Hz 400 V at 60 Hz	3N~	---

- The domestic socket must also provide a protective conductor. Make sure that the connection of the protective conductor of the domestic installations to the chamber's protective conductor meets the latest technology. The protective conductors of the socket and plug must be compatible!

	 <b>DANGER</b>
	<p><b>Electrical hazard due to missing protective conductor connection.</b> <b>Deadly electric shock.</b></p> <ul style="list-style-type: none"> <li>➤ Make sure that the chamber's power plug and the power socket match and securely connect the electrical protective conductors of the chamber and the house installation.</li> </ul>

- Only use original connection cables from BINDER according to the above specification.
- Prior to connection and start-up, check the power supply voltage. Compare the values to the specified data located on the chamber's type plate (left-hand side of the chamber, chap. 1.6).

	<b>NOTICE</b>
	<p><b>Danger of incorrect power supply voltage due to improper connection.</b> <b>Damage to the chamber.</b></p> <ul style="list-style-type: none"> <li>➤ Check the power supply voltage before connection and start-up.</li> <li>➤ Compare the power supply voltage with the data indicated on the type plate.</li> </ul>

- When connecting, please observe the regulations specified by the local electricity supply company as well as the local or national electrical regulations (VDE directives for Germany).
- Observe a sufficient current protection according to the number of devices that you want to operate. We recommend the use of a residual current circuit breaker.
- Do not place the power cable over the door gap when the chamber is hot after operation.
- Pollution degree (acc. to IEC 61010-1): 2
- Over-voltage category (acc. to IEC 61010-1): II

See also electrical data (chap. 22.4).

	<p>To completely separate the chamber from the power supply, you must disconnect the power plug. Install the chamber in a way that the power plug is easily accessible and can be easily pulled in case of danger.</p>
---	--



## 4.2 Connection to an exhaust/ventilation system (optional)

Active suction from the chamber must only be effected together with external air. Therefore, the chamber's exhaust air duct shall not be immediately connected to an active exhaust system.

When connecting to an active exhaust system, proceed as follows:

- Perforate the connecting piece between the exhaust air duct and the exhaust system.

Or

- Use an exhaust air funnel placed in a distance of 3-5 cm / 1 to 2 in from the exhaust air duct. The funnel's opening must be at least twice as large as the diameter of the exhaust air duct.



If improperly connected to an active exhaust/ventilation system, the spatial temperature exactitude (uniformity), the heating-up and recovering times as well as the maximum temperature of the chamber may be negatively affected.

The exhaust duct on the chamber rear will become hot during operation



### CAUTION

**Danger of burning by touching hot chamber parts during operation.**

**Burns.**

- ⊘ Do NOT touch the exhaust duct during operation.

## 4.3 Inserting the racks

Observe the correct orientation of the racks:

**Standard rack:** The lateral brackets must be above the rack surface when inserting the rack.

**Optional heavy load rack:** The lateral brackets must be below the rack surface when inserting the rack.

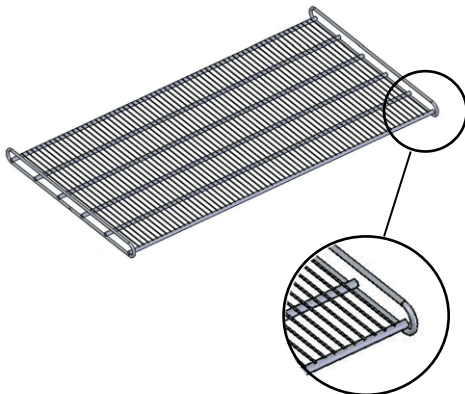

Standard rack

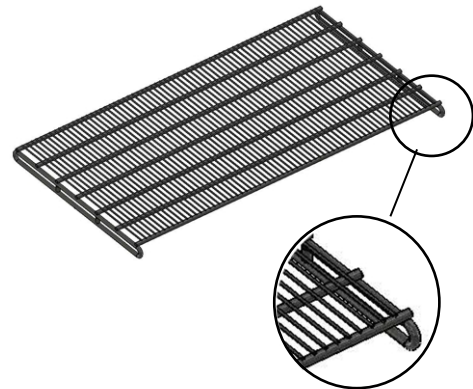

Optional heavy load rack

Figure 10: Correct orientation when inserting the racks



### WARNING

**Risk of injury by racks falling down due to incorrectly inserting the racks.**

**Injuries.**

- Use only racks intended for this chamber model.
- Observe the correct orientation of the racks when inserting them.



## 5. Functional overview of the MB2 chamber controller

The MB2 chamber controller controls the temperature (closed loop control) and fan speed inside the chamber.

You can enter the desired set point values in fixed value operation mode directly on the display surface or via the setpoint menu. For program operation the controller offers programming week and time programs. In addition, there is a timer program available (stopwatch function).

The controller offers various notifications and alarm messages with visual and audible indication and remote alarms via e-mail, an event list (trace file) and the graphical display of the measuring values in the chart recorder view. The MB2 program controller permits programming temperature cycles, and specifying fan speed and special controller functions for each program section. You can enter values or programs directly at the controller or use the APT-COM™ 4 Multi Management Software (option) specially developed by BINDER.

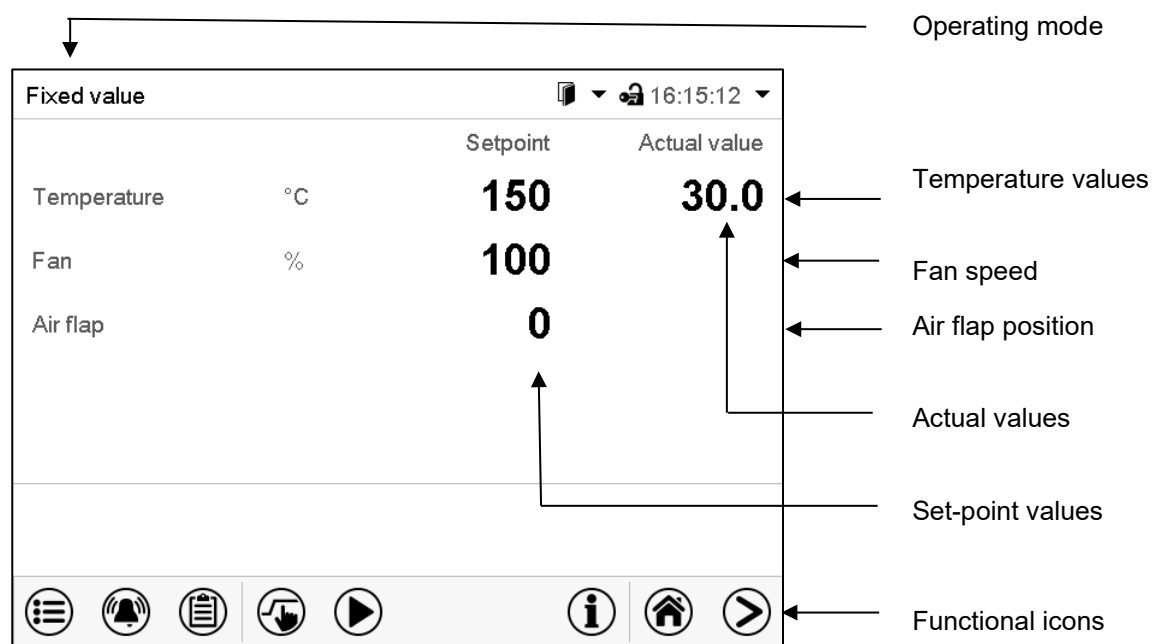

Figure 11: Normal display of the MB2 program controller (sample values)

## 5.1 Operating functions in normal display

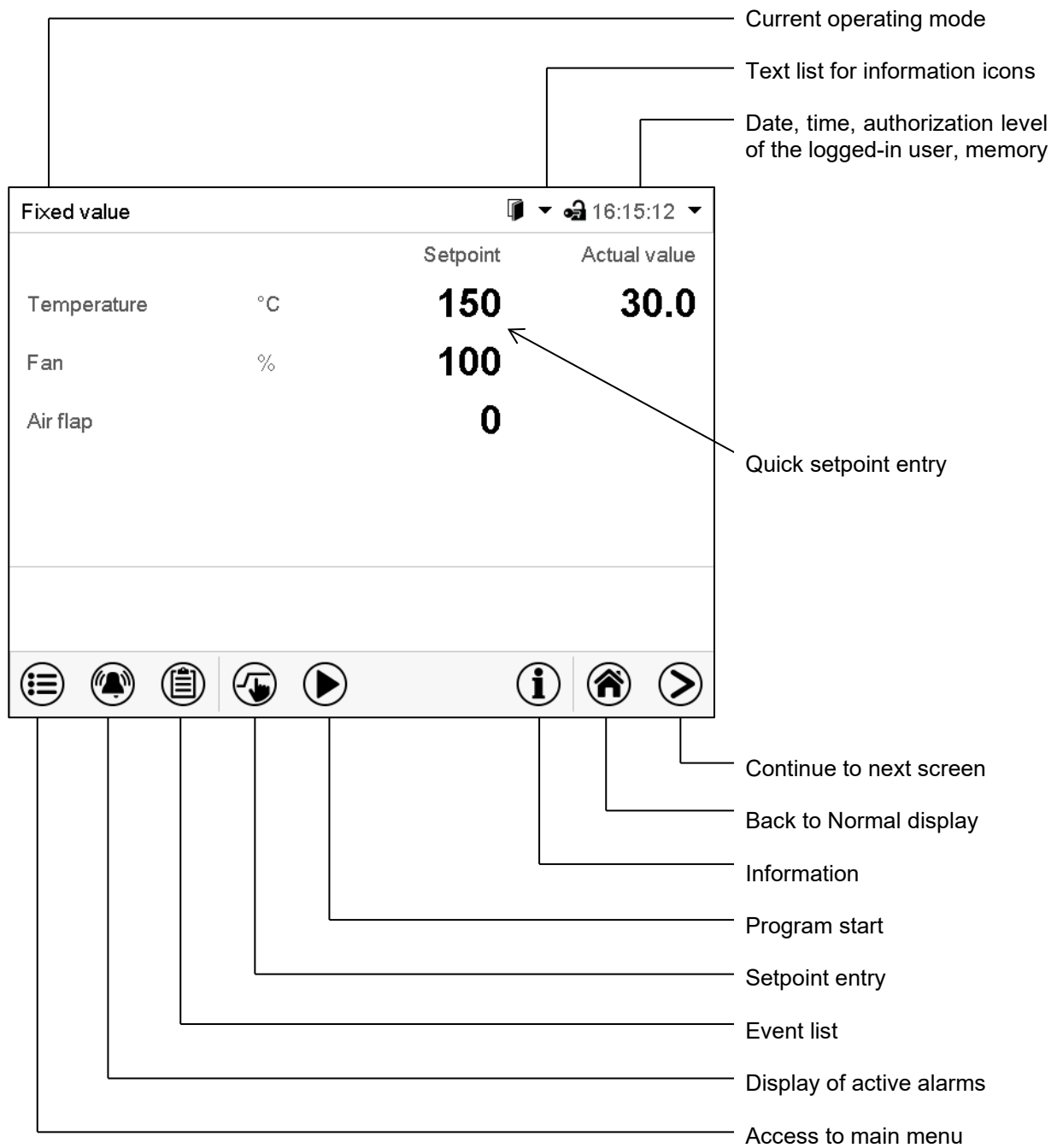
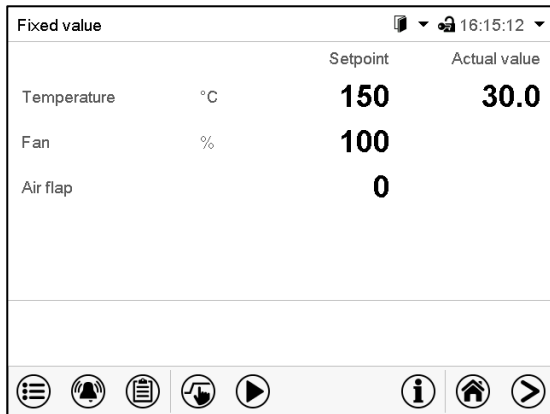

Figure 12: Operating functions of the MB2 controller in normal display (example values)

## 5.2 Display views: Normal display, program display, chart-recorder display

	Press the <b>Change view</b> icon to toggle between normal display, program display and chart-recorder display.
	Press the <b>Normal display</b> icon to return from program display and chart recorder display back to Normal display.



Normal display (actual values / setpoint values)

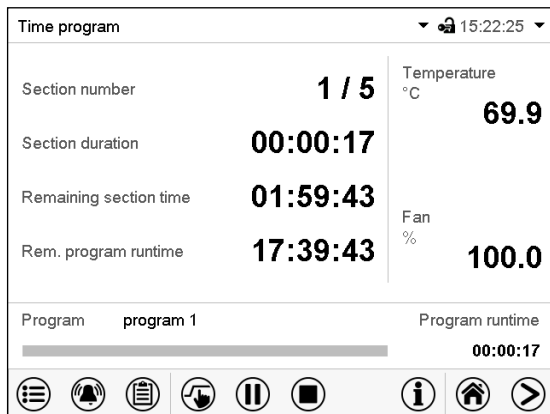

Program display (example: time program)

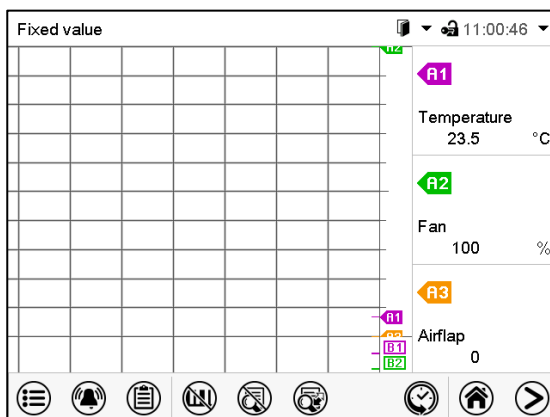



















Chart recorder display

## 5.3 Controller icons overview











### Navigation icons in Normal display

Icon	Signification	Function
	<b>Main menu</b>	Access from Normal display to the main menu
	<b>Alarm</b>	Access from Normal display to the list of active alarms
	<b>Event list</b>	Access from Normal display to the event list
	<b>Setpoint setting</b>	Access from Normal display to the setpoint entry menu: setpoint entry for Fixed value operation, safety controller settings
	<b>Program start</b>	Start a previously entered time or week program, continue a paused time program
	<b>Program pause</b>	Pause a running time program
	<b>Program cancelling</b>	Cancel a running time or week program
	<b>Information</b>	Information on program operation, setpoints, actual values, and the safety controller
	<b>Normal display</b>	Return from program display or chart recorder display to Normal display
	<b>Change view</b>	Toggle between Normal display, program display, and chart recorder display





### Functional icons in individual menus

Icon	Signification	Function
	<b>Back</b>	Return from each menu to Normal display
	<b>Update</b>	Update the event list and alarm messages
	<b>Confirm</b>	Take over the entries and exit the menu / continue menu sequence.
	<b>Close</b>	Exit the menu / cancel menu sequence. Entries are not taken over. When terminating a menu sequence, an information window appears, which must be confirmed.
	<b>Reset alarm</b>	Acknowledge the alarm and mute the buzzer.
	<b>Change keyboard</b>	Change between uppercase and lowercase characters, digits and special characters
	<b>Edit</b>	Edit settings of time and week programs

### Functional icons in the chart recorder display

Icon	Signification	Function
	<b>Show legend</b>	Show legend
	<b>Hide legend</b>	Hide legend
	<b>Switch legend</b>	Switch between legend pages
	<b>Show indications</b>	Show the indications of temperature (A1), fan (A2), air flap (A3), "Door open" (B1), and "Idle mode" (B2)
	<b>Hide indications</b>	Hide the indications of temperature (A1), fan (A2), air flap (A3), "Door open" (B1), and "Idle mode" (B2)
	<b>History display</b>	Pause chart recorder and change to history display. Data recording continues.
	<b>Curve selection</b>	Go to "Curve selection" submenu in the history display
	<b>Search</b>	Go to "Search" submenu in the history display to select the required instant
	<b>Zoom</b>	Go to "Zoom" submenu in the history display to select the zoom factor
	<b>Show scroll buttons</b>	Show scroll buttons in the history display to scroll to an instant
	<b>Hide scroll buttons</b>	Hide scroll buttons in the history display to scroll to an instant

### Information icons referring to chamber conditions

Icon	Text information	Condition
	"Idle mode"	Controller in Idle mode
	"Temperature range"	Current actual temperature value outside the tolerance range
	"Door open"	Chamber door is open
	"Switching output"	Switching output is activated
	"Object control"	Object temperature control activated (option)

### Information icon for data processing

Icon	Information
	Waiting icon: Data processing is running. Remaining time to touch the display when calibrating the touchscreen.

## 5.4 Operating modes

The MB2 program controller operates in the following operating modes:

- **Idle mode**

The controller is not functional, i.e., there is no heating or refrigeration. The fan is off. The chamber approximates ambient values.

You can activate and deactivate this operating mode with the "Idle mode" control contact in Fixed value operating mode (chap.11.6.5), time program operation (chap. 10.7.3) and week program operation (chap. 11.6.5).

- **Fixed value operating mode**

The controller operates as a fixed-point controller, i.e., set-points can be defined, which are then maintained until the next manual change (chap. 8.1).

- **Timer program operation**

Stopwatch function: during an entered duration the controller constantly equilibrates to the setpoints entered in Fixed value operation mode.

- **Time program operation**

An entered time program for temperature is running. The controller offers 25 program memory places with 100 program sections each. The total number of program sections of all programs is unlimited

- **Week program operation**









An entered week program for temperature is running. The controller offers 5 program memory places with 100 switching points each. The switching points can be distributed over all days of the week.

## 5.5 Controller menu structure

Use the **navigation icons** in the screen footer in Normal display to access the desired controller functions.







Fixed value		Setpoint	Actual value
Temperature	°C	<b>150</b>	<b>30.0</b>
Fan	%	<b>100</b>	
Air flap		<b>0</b>	

							
---	---	---	---	---	---	---	---

Normal display

The available functions depend on the current **authorization level** “Service”, “Admin” or “User” (chap. 14.1). This is selected either during login or can be available without password protection.



	<b>Main menu:</b> program settings, further information, “Service” submenu. The “Settings” submenu allows general configuration of the controller.	chap. 5.5.1
	List of <b>active alarms</b>	chap. 12.3
	Access to the <b>event list</b>	chap. 16.2
	<b>Setpoint entry</b> for Fixed value operation, <b>safety controller</b> settings	chap. 8, 13.2
  	Start/ pause/ cancel an already entered, respectively a running <b>time program</b> or start / cancel an already entered, respectively a running <b>week program</b>	chap. 10.1, 10.2, 11.1

Unless noted otherwise, the figures show the functional range, which is available for the user with “Admin” authorization level.





### 5.5.1 Main menu

The main menu provides access to the general configuration of the controller as well as to program entry and the user administration. Additionally, there are support functions like a contact page or the display calibration depending on the available angle.

	Press the <b>Main menu</b> icon to access the main menu from Normal Display.
	Press the <b>Back</b> icon to return from each setting menu to Normal Display.

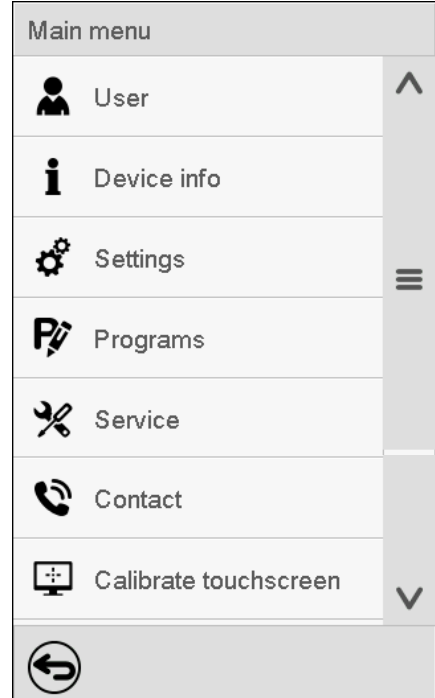
The main menu provides the following functions and submenus.

			
	User	User management: login and logout, password management	chap. 14
	Device info	Chamber information	chap. 16.2
	Settings	“Settings” submenu (not visible for user with “User” authorization level)	chap. 13.3
	Programs	Program entry submenu for time and week programs	chap. 10 and 11
	Service	“Service” submenu	chap. 5.5.3
	Contact	BINDER Service contact page	chap. 16.1
	Calibrate touchscreen	Calibrating the touch screen	chap. 15.4.2
	Back to Normal Display		

#### “Settings” submenu

- Settings of many general controller functions and network settings (chap. 13.3).
- Available only for users with “Service” and “Admin” authorization level

#### “Service” submenu

- Access to service data, controller reset to factory settings (chap. 5.5.3)
- Available only for users with “Service” and “Admin” authorization level. Full functional range only for BINDER Service (users with “Service” authorization level).

#### “Programs” submenu

- Access to the controller’s program functions (chap. 9, 10, 11)

### 5.5.2 “Settings” submenu

The “Settings” submenu is available for users with “Service” or “Admin” authorization level. It serves to enter date and time, select the language for the controller menus and the desired temperature unit and to configure the controller’s communication functions.

Path: [Main menu](#) > [Settings](#)

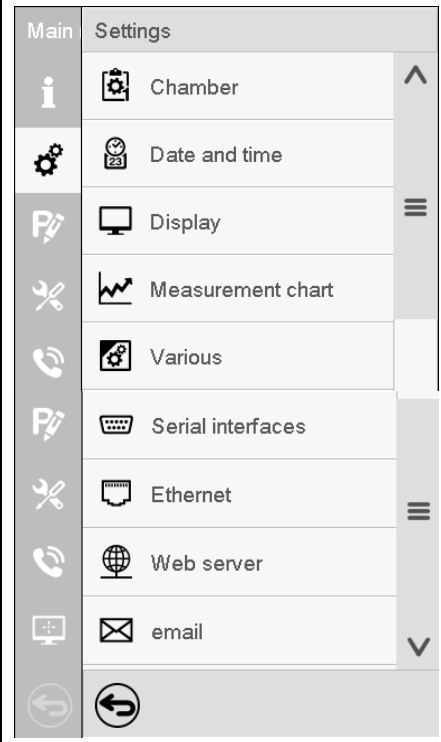
		
	Setting the temperature unit, menu language...	chap. 15.1, 15.2
	Setting date and time	chap. 15.2
	Setting the display brightness, continuous operation and screen saver	chap. 15.4
	Settings for the measurement chart: storage interval, storage values, minimum and maximum values	chap. 17.2
	Setting the tolerance range and delay time for tolerance range alarm	chap. 12.4
	Entry of the MAC address and IP address	chap. 15.5.1
	No function	
	Configuration of the e-mail server, assignment of e-mail addresses	chap. 15.5.3
	Back to main menu	

### 5.5.3 “Service” submenu

The “Service” submenu is available for users with “Service” or “Admin” authorization level. When logged-in with “Admin” authorization level the user will find information to tell the BINDER Service in service case.

Path: [Main menu](#) > [Service](#)

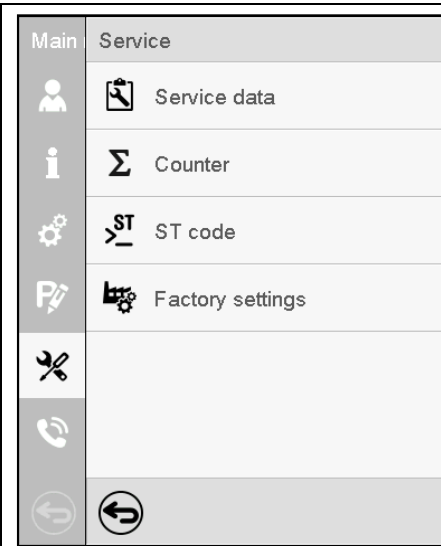
	Serial number of the chamber, setup version of the controller software	chap. 15.2
	No function	
	Information for BINDER Service	
	Reset to factory settings	
	Back to main menu	

(view with “Admin” authorization level)

## 5.6 Principle of controller entries

In the selection and entry menus there are icons displayed in the footers which you can use to take over the entry or cancel it.

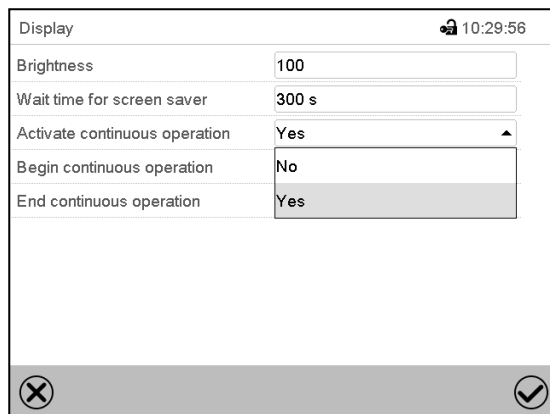

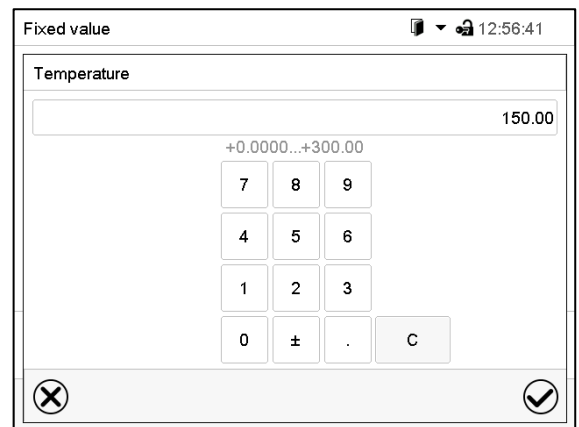

Selection menu (example)



Entry menu (example)

After completing the settings there are the following possibilities:

	Press the <b>Confirm</b> icon to take over the entries and exit the menu or continue the menu sequence.
	Press the <b>Close</b> icon to exit the menu or cancel the menu sequence without taking over the entries. When terminating a menu sequence, an information window appears, which must be confirmed.

## 5.7 Performance during and after power failures

During a power failure, all controller functions are shut down. The zero-voltage relay alarm output (option, chap. 13.3) is switched to alarm position for the whole duration of the power failure.

After the power returns, all functions return to the same status the chamber had before power failure. The controller continues to function in the original operating mode it was in previously before the power failure occurred.

- Performance after power failure in Idle mode  
Control is deactivated
- Performance after power failure in Fixed value operation mode  
All functions return to the same status the chamber had before power failure. The set-points are immediately resumed.
- Performance after power failure during time program operation  
The program is resumed at the point where the interruption occurred with the latest set-points reached during the program run.
- Performance after power failure during week program operation  
The week program continues with the values corresponding to the current time.

Power failure and power return are noted in the event list (chap. 16.3).

If during power failure an alarm has occurred (tolerance range, overtemperature, safety controller), confirm the alarm. See chap. 12.3.

## 5.8 Performance when opening the door

When you open the door, heating and fan turn off.

After closing the door, heating, and fan turn on again.

## 6. FailSafe function

The chambers are equipped with the "FailSafe" safety function: The chamber has two Pt100 temperature sensors for mutual monitoring and function takeover in the event of an error.

The **regular temperature sensor** normally supplies the temperature data. In the event of an error, i.e. if it no longer supplies any data that can be processed, the additional **FailSafe temperature sensor** takes over the recording of the measured values. For information, the alarm message "Sensor defective!" is issued (chap. 12.1.2), but the chamber continues to function and displays the correct temperature value.

Contact BINDER Service to replace the defective sensor.

## 7. Start up

### 7.1 Turning on the chamber

Insert the plug into a suitable socket (chap. 4.1).

- M up to size 115: Turn on the chamber at the on/off switch (4).
- M 260 and 720: Turn on the chamber at the main power switch (11) (chap. 2.4).

The lit pilot lamp shows the chamber is ready for operation.

When the on/off switch (4) or main power switch (11) is turned on and yet the controller display is dark, the display is in stand-by mode. Press on the touchscreen to activate it.

Warming chambers may release odors in the first few days after commissioning. This is not a quality defect. To reduce odors quickly we recommend heating up the chamber to its nominal temperature for one day and in a well-ventilated location.



**WARNING:** If customer should use a BINDER chamber running in non-supervised continuous operation, we strongly recommend in case of inclusion of irrecoverable specimen or samples to split such specimen or samples and store them in at least two chambers, if this is feasible.

### 7.2 Controller settings upon start up

The window "Language selection" enables the **language selection**, in case that it's activated in the "Start-up" menu. Afterwards occurs a request of the **time zone** and the **temperature unit**.

Language selection	
German	<input checked="" type="checkbox"/>
English	<input type="checkbox"/>

Start-up	
Temperature unit	Degrees Celsius
Time zone	UTC+1h (CET)
Daylight saving time switch	Automatic
Start of daylight saving time	
End of daylight saving time	
Language query after restart	Yes

The controller will function in the **operating mode**, which was active before the last shut-down. It controls temperature in fixed value operating mode to the last entered value and in the program mode to the set point achieved beforehand.

## Locked operation

Provided that the user administration has been activated by the assignment of passwords for the different authorization types, the **controller operation** is first locked after turning on the unit, recognizable by the closed lock icon in the header.

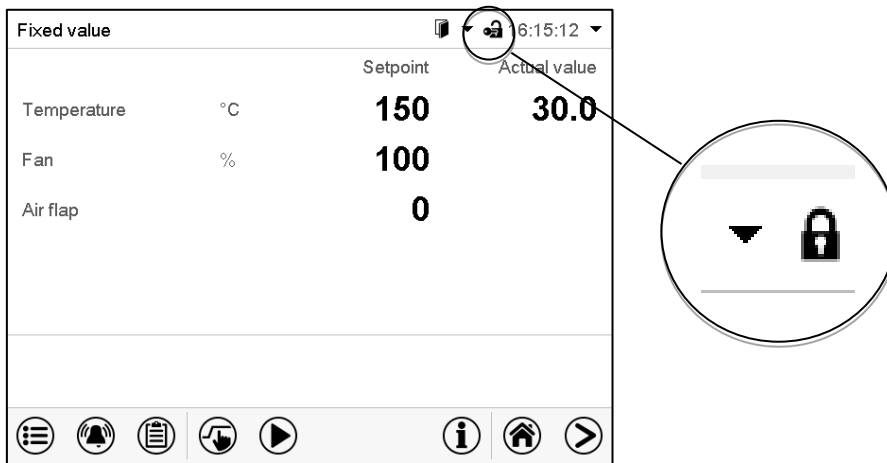

In the locked view the controller provides all display functions. No setting functions are available.

The setpoints are shaded (light grey) in normal display. Changing them by direct entry in the fixed value operating mode is not possible. The functional icons for setpoint entry and program start in the footer are without function.

After turning on the unit, user log-in is required to operate the controller (chap. 14.2)



### Operation without user log-in / without password-protection

If the password function has been deactivated, after turning on the unit without user log-in there are those controller functions available, which correspond to the highest authorization level without a password protection. There is no lock icon in the header.

## 7.3 Loading

When loading the chamber, observe the maximum permissible load per rack and the maximum permissible total load (see technical data, chap. 22.4).

Observe the correct orientation of the racks (chap. 4.3).

 	 <b>WARNING</b>
	<p><b>Risk of injury by racks falling down due to overload.</b></p> <p><b>Injuries.</b></p> <ul style="list-style-type: none"> <li>∅ Do not exceed the maximum permissible load per rack.</li> <li>∅ Do not exceed the maximum permissible total load.</li> <li>➤ Gently place the load on the racks.</li> <li>➤ Distribute the load as evenly as possible.</li> </ul>

## 8. Set-point entry in “Fixed value” operating mode

In Fixed value operating mode, you can enter a temperature set-point, the fan speed, adjust the air flap position and the switching-state of special controller functions via operation lines.

All settings made in Fixed value operating mode remain valid until the next manual change. They are saved also when turning off the chamber or in case of toggling to Idle Mode or Program Mode.

	Setting ranges	Control ranges
Temperature	0.0 °C / 32 °F up to 300 °C / 572 °F	M 56, M 115: 22 °C above ambient temperature up to 300 °C / 572 °F M 260, M 720: 15 °C above ambient temperature up to 300 °C / 572 °F
Fan speed	40% up to 100 %	
Air flap	0 (closed) up to 4 (open) in steps of 15°	



Reduce the fan speed only if required, because the spatial distribution of temperature will also be reduced.

**Technical data refers to 100% fan speed.**



With set-point type “Limit”, adapt the safety controller (chap. 13.2) always when you changed the temperature set-point. Set the safety controller set-point by approx. 5 °C above the controller temperature set-point.

Recommended setting: Set-point type “Offset” with safety controller set-point 5 °C.

### 8.1 Set-point entry for temperature and fan speed through the “Setpoints” menu



Press the **Setpoint setting** icon to access the “Setpoint” setting menu from Normal display.

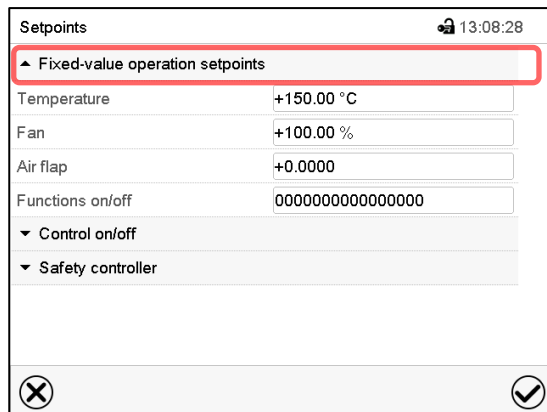

“Setpoints” menu.

(standard view without the object temperature control option)

Select “Fixed value operation setpoints” to access the individual parameters.

- Select the field “Temperature” and enter the desired temperature setpoint.  
Setting range: 0 °C / 32 °F up to 300 °C / 572 °F . Confirm entry with **Confirm** icon.
- Select the field “Fan” and enter the desired fan speed setpoint.  
Setting range: 40% up to 100% fan speed. Confirm entry with **Confirm** icon.
- Adjusting the air flap position, see chap. 8.2.
- For setting the object temperature control option, see chap. 18.3.



When entering a value outside the setting range, the message: “Value outside of limits! (Min: xxx, Max: xxx)” appears (xxx is a wildcard for the limits of the respective parameter). Press the **Confirm** icon and repeat the entry with a correct value.

After completing the settings, press the **Confirm** icon to take over the entries and exit the menu, or press the **Close** icon to exit the menu without taking over the entries.

## 8.2 Adjusting the air flap position through the “Setpoints” menu

Opening the air flap in the exhaust duct serves to adjust the air change.

The position of the air flap in the exhaust duct serves to adjust the fresh air entry. With the open the air flap, fresh air can enter. Fan operation will increase fresh air entry.

If the air flap is completely open, the spatial temperature accuracy can be negatively influenced.

The position of the air flap can be controlled via the controller and the written program.

There are the following options:

Air flap closed 0	Air flap slightly opened 1	Air flap half opened 2	Air flap almost open 3	Air flap open 4

The setting can be done in steps of 15°.

Required access level: “User”.



As part of an automatic function test, the exhaust air flap opens briefly every 24 hours.

### Setting



Press the **Setpoint setting** icon to access the “Setpoint” setting menu from Normal display.

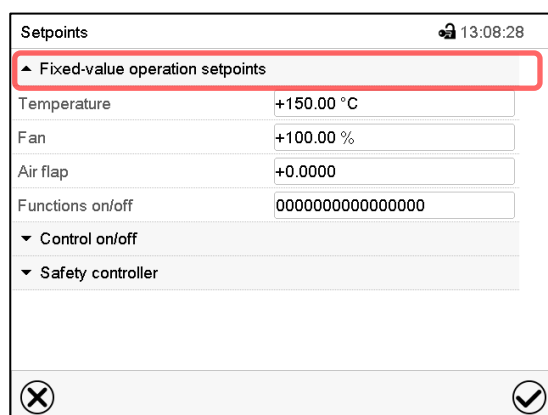

“Setpoints” menu.

(standard view without the object temperature control option)

Select “Fixed value operation setpoints” to access the individual parameters.

- Select the field “Air flap” and enter the desired position „0“ to „4“..  
Setting range: Position „0“ (closed) up to „4“ (open). Confirm entry with **Confirm** icon

### 8.3 Direct setpoint entry via Normal display

Alternatively you can also enter the setpoints for temperature and the fan speed, the air flap position and the switching-state of special controller functions directly via Normal display.

#### Temperature setpoint entry

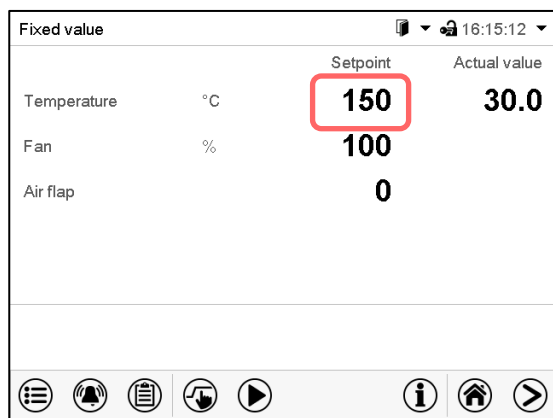

Normal display.  
Select the temperature setpoint.

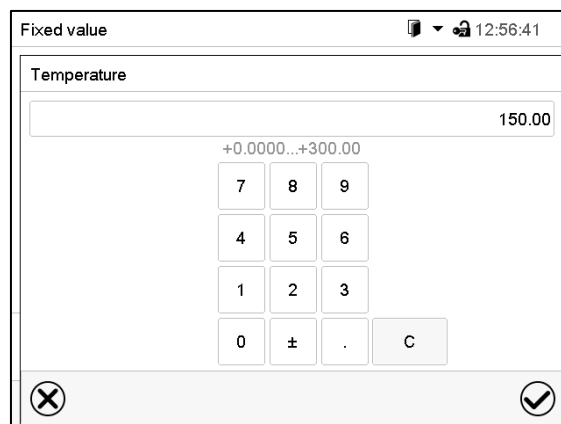

"Temperature" entry menu.  
Enter the desired setpoint and confirm entry with **Confirm** icon.

#### Fan setpoint entry

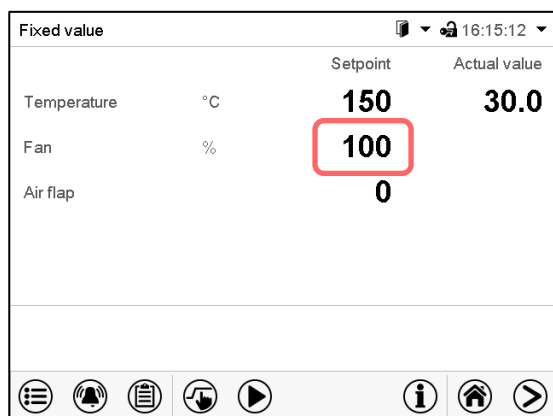

Normal display.  
Select the fan speed setpoint.

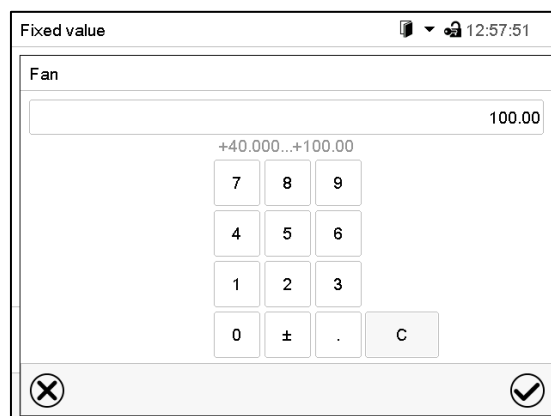

"Fan" entry menu.  
Enter the desired setpoint and confirm entry with **Confirm** icon.

#### Entry of the air flap position

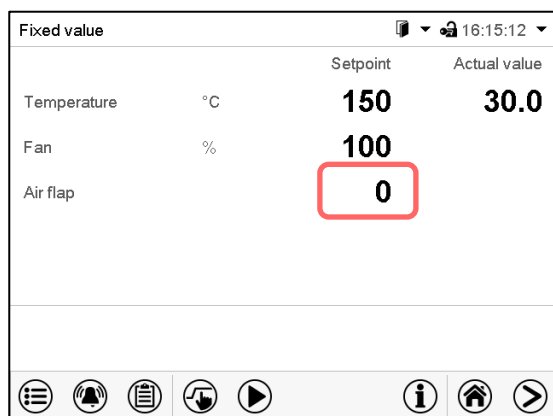

Normal display.  
Select the air flap position.

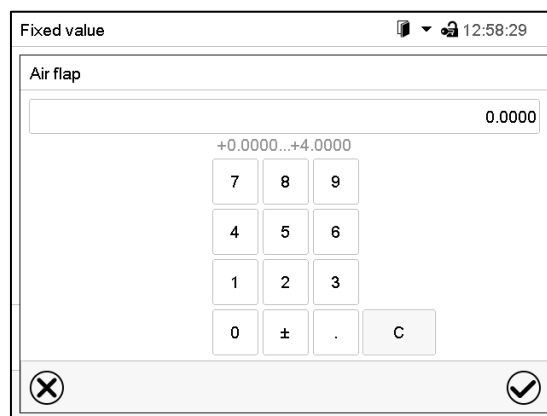

"Air flap" entry menu.  
Enter the desired setpoint and confirm entry with **Confirm** icon.



## 8.4 Special controller functions via operation lines

 Press the **Setpoint setting** icon to access the “Setpoint” setting menu from Normal display.

You can define the switching state of up to 16 operation lines (control contacts). They are used to activate / deactivate special controller functions.

- Operation line “Idle mode” activates / deactivates the operating mode “Idle mode” (chap. 5.4). This mode serves to deactivate all chamber functions except the controller. With operating mode “Idle mode”, the heating and fan are deactivated.
- Operation line “Switching output” is used to switch on/off the zero-voltage switching contact
- Operation line “Object control” is used to switch on/off the object temperature control (option). This operation line is visible only at units with the object temperature control option.

The other operation lines are without function.

Use the “Setpoints” menu to configure the operation lines.

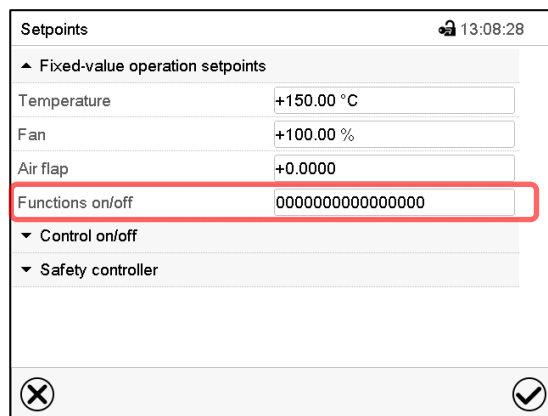

“Setpoints” menu.

Select the field “Functions on/off”.

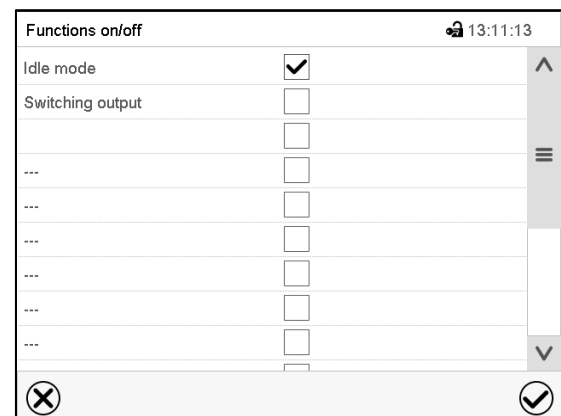

“Functions on/off” entry menu.

Mark / unmark the checkbox to activate / deactivate the desired function and press the **Confirm** icon.

Activated operation line: switching status “1” (On)

Deactivated operation line: switching status “0” (Off)

The operation lines count from right to left.

### Example:

Activated operation line “Idle mode” = 00000000000000001

Deactivated operation line “Idle mode” = 00000000000000000

## 9. Timer program: stopwatch function

During an entered duration the controller constantly equilibrates to the setpoints entered in Fixed value operation mode (temperature, fan speed, configuration of the operation lines). This duration can be entered as a “Timer program”. During the program runtime, any setpoint changes do not become effective; the controller equilibrates to the values which were active during program start.

## 9.1 Starting a timer program

 In Normal display press the **Program start** icon to access the “Program start” menu.

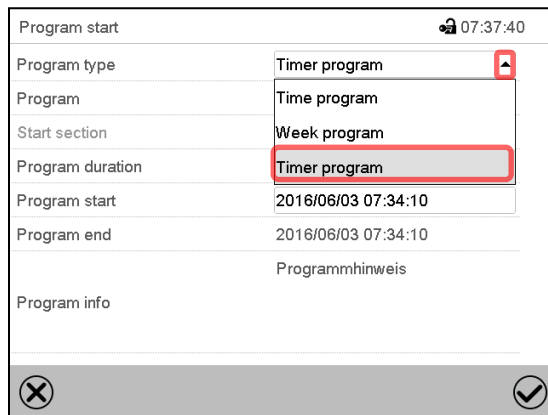

“Program start” menu

- In the field “Program type” select “Timer program”.
- Select the field “Program duration” and enter the desired program duration. Press the **Confirm** icon.
- Select the field “Program start” and enter the desired start time of the program in the “Program start” entry menu. Press the **Confirm** icon. The program delay time until program start begins.

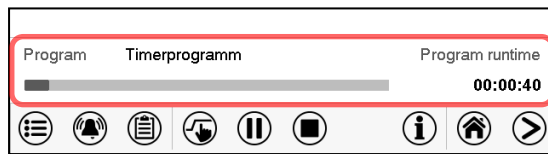

Normal display.

Information on the bottom of the screen indicates the currently running program and the time already passed. The grey bar shows how much time of the whole time is elapsed.

### 9.1.1 Performance during program delay time

During the configured program delay time until program start, the controller equilibrates to the current setpoints of Fixed value operation mode. Modifications of these setpoints are possible but become effective only after the timer program is finished. When the configured moment for program start is reached, the program delay time ends and the program starts running. The controller equilibrates to the values which had been active during program start

## 9.2 Cancelling a running timer program

 Press the **Program cancelling** icon to cancel the program.

A confirmation prompt is displayed. Press the **Confirm** icon to confirm that the program shall really be cancelled.

After confirming the message, the controller changes to Fixed value operation mode. The setpoints of Fixed value operation mode will then equilibrate.

## 9.3 Performance after the end of the program

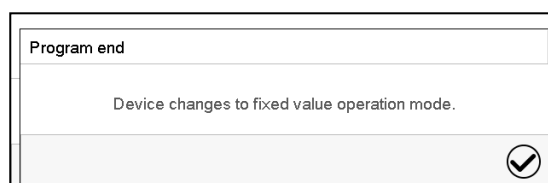

After the end of the program the message “Device changes to fixed value operation mode” appears on the screen.

Press the **Confirm** icon.

After confirming the message, the controller changes to Fixed value operation mode. The setpoints of Fixed value operation mode will then equilibrate.

## 10. Time programs

The MB2 program controller permits programming time programs with real-time reference. It offers 25 program memory positions with up to 100 program sections each.

For each program section you can enter a temperature set-point, fan speed, section duration, type of temperature transition (ramp or step) and the tolerance range.



If the safety controller has been set to “limit” mode, check the setting of the safety controller when changing the temperature set-point (chap. 13.2).



Reduce the fan speed only if required, because the spatial distribution of temperature will also be reduced.

**Technical data refers to 100% fan speed.**



Programming remains saved in case of a power failure or after turning off the unit.

Path: [Main menu](#) > [Programs](#) > [Time program](#)

### 10.1 Starting an existing time program



In Normal display press the **Program start** icon to access the “Program start” menu.

Program start		08:07:19
Program type	Time program	
Program	program 1	
Start section	1	
Program duration		
Program start	2016/06/03 08:04:24	
Program end	2016/06/06 23:04:24	
Program info		
		 

“Program start” menu

- In the field “Program type” select the setting “Time program”.
- In the field “Program” select the desired program.
- Select the field “Program start” and enter the desired program start time in the “Program start” entry menu. Press the **Confirm** icon. The program delay time until program start begins.

The program end is adapted automatically depending on the entered program duration.

After completing the settings, press the **Confirm** icon to take over the entries and exit the menu. The program starts running.

If instead you press the **Close** icon to exit the menu without taking over the entries, the program will not start.

Program	program 1	Program runtime
		00:01:23
        		

Normal display. Information on the bottom of the screen indicates the currently running program and the time already passed. The grey bar shows how much time of the whole time is elapsed. If program duration has been set to infinite, the grey bar is not displayed.

### 10.1.1 Performance during program delay time

During the configured program delay time until program start, the controller equilibrates to the current setpoints of Fixed value operation mode. Modifications of these setpoints are effective. When the configured moment for program start is reached, the program delay time ends and the program starts running.



## 10.2 Stopping a running time program

### 10.2.1 Pausing a running time program

	Press the <b>Program pause</b> icon to interrupt the program.
---	---

The program is paused. The program runtime stops running down, the time display flashes.

There are the following options:

	Press the <b>Program start</b> icon to continue the program
	Press the <b>Cancelling</b> icon to cancel the program

### 10.2.2 Cancelling a running time program

	Press the <b>Program cancelling</b> icon to cancel the program.
--	---

A confirmation prompt is displayed. Press the **Confirm** icon to confirm that the program shall really be cancelled.

After confirming the message, the controller changes to Fixed value operation mode. The setpoints of Fixed value operation mode will then equilibrate.

## 10.3 Performance after the end of the program

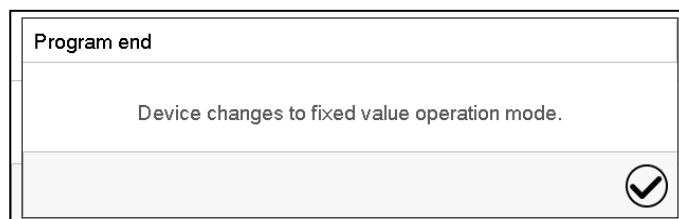

After the end of the program the message "Device changes to fixed value operation mode" appears on the screen.

Press the **Confirm** icon.

As long as the message has not been confirmed, the setpoint of the last program section remains effective. Program the last section as desired. If e.g. heating and refrigeration shall turn off, activate operation line "Idle mode" in the last program section.

After confirming the message, the controller changes to Fixed value operation mode. The setpoints of Fixed value operation mode will then equilibrate.

## 10.4 Creating a new time program

Path: [Main menu](#) > [Programs](#) > [Time program](#)

No.	Program name
1	program 1
2	program 2
3	< empty >
4	< empty >
5	< empty >
6	< empty >
7	< empty >
8	< empty >
9	< empty >
10	< empty >

“Time program” menu:  
overview of the existing programs.  
Select an empty program place.



Enter the program name and, if desired, additional program information in the corresponding fields.

Press the **Confirm** icon.

The program view opens (chap. 10.5).

## 10.5 Program editor: program management

Path: [Main menu](#) > [Programs](#) > [Time program](#)

No.	Program name
1	program 1
2	program 2
3	program 3
4	< empty >
5	< empty >
6	< empty >
7	< empty >
8	< empty >
9	< empty >
10	< empty >

“Time program” menu:  
overview of the existing programs.  
Select an existing program (example: program 3) or create a new program (chap. 10.4).  
The program view opens.



No.	Duration [hh:mm:ss]	Temperature [°C]	Fan [%]	Air flap	...
1	00:00:01	300.00	100.00	4.0000	...

Program view (example: program 1).

If a new program has been created, there is just one program section.

There are the following options:

- ① Select a program section to open the section editor (chap. 10.6)
- ② Press the **Edit** icon to open the program editor

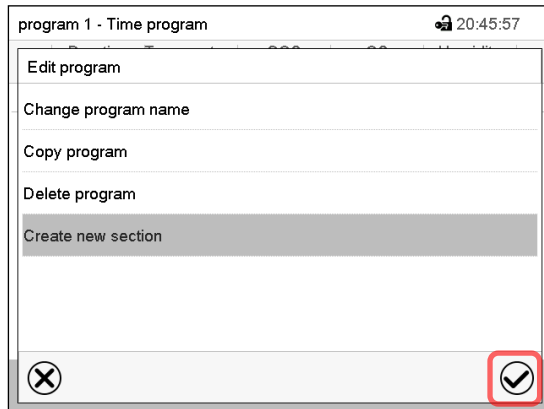

Program editor: “Edit program” menu

Select the desired function and press the **Confirm** icon.

The program editor offers following options:

- Change the program name
- Copy program
- Replace program: Replacing a new or an existing program with the copied program. This menu point is visible only after a program has been copied.
- Delete program
- Create new section

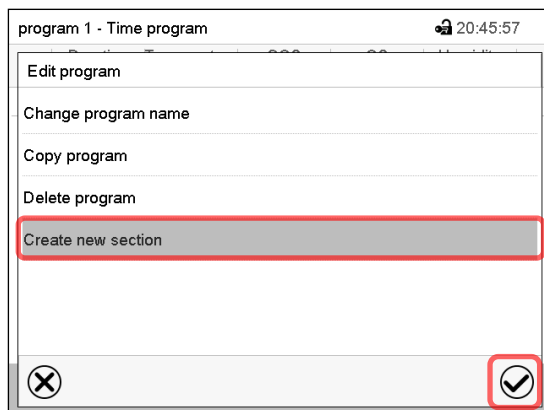

To add a new section, select “Create new section” and press the **Confirm** icon.

The program view opens.



No.	Duration [hh:mm:ss]	Temperature [°C]	Fan [%]	Air flap [ ]	...	...	...
1	02:00:00	70.000	100.00	4.0000	...	...	...
2	00:00:01	70.000	100.00	4.0000	...	...	...

Program view.

A new section is always added at the very bottom (example: section 2).

### 10.5.1 Deleting a time program

Path: [Main menu](#) > [Programs](#) > [Time program](#)

In the “Time program” menu select the program to be deleted. The program view opens.



In the **program view** press the **Edit** icon to open the program editor



In the **program editor** select “Delete program” and press the **Confirm** icon.

The program is deleted. The controller returns to the program view.

## 10.6 Section editor: section management

Path: [Main menu](#) > [Programs](#) > [Time program](#)

Select the desired program.

No.	Duration [hh:mm:ss]	Temperature [°C]	Fan [%]	Air flap □	...
1	02:00:00	70.000	100.00	4.0000	...
2	00:00:01	70.000	100.00	4.0000	...

Program view.

Select the desired program section  
(example: section 1)

program 1 - Section number 1	
Duration	02:00:00
Course	Ramp <span style="border: 1px solid red; border-radius: 50%; padding: 2px;">1</span>
Functions on/off	0000000000000000 <span style="border: 1px solid red; border-radius: 50%; padding: 2px;">2</span>
Number of repetitions	0
Start section for repetition	1
Temperature	+70.000
Tolerance band min.	+0.0000
Tolerance band max.	+0.0000
Fan	+100.00

Section view (example: section 1).

There are the following options:

- ① Select a parameter to enter or modify the according value (chap. 10.7)
- ② Press the **Edit** icon to open the program editor

program 1 - Section number 1	
Edit section	
Copy section	
Delete section	
Create new section	

Section editor: "Edit section" menu

Select the desired function and press the **Confirm** icon.

The section editor offers following options:

- Copy section
- Replace section: Replacing an existing section with the copied section. This menu point is visible only after a section has been copied.
- Insert section: Adding the copied section. This menu point is visible only after a section has been copied.
- Delete section
- Create new section

### 10.6.1 Add a new program section

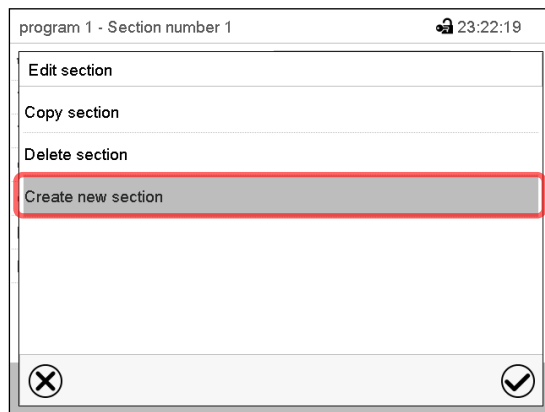

Section editor: "Edit section" menu.

Select "Create new section" and press the **Confirm** icon.

Then select whether to insert the new section before or after the current section.

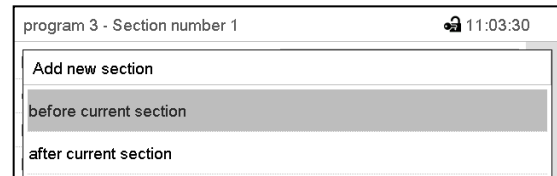

Press the **Confirm** icon. The new section opens.

### 10.6.2 Copy and insert or replace a program section

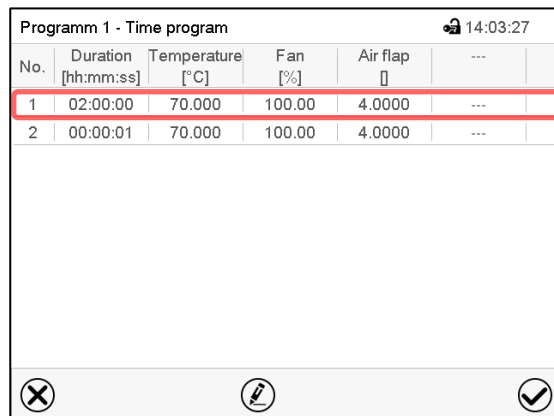

Program view.

Select the program section to be copied (example: section 1)

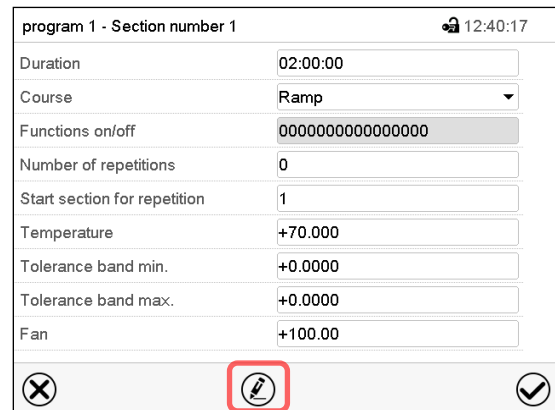

Section view (example: section 1).

Press the **Edit** icon to open the section editor.

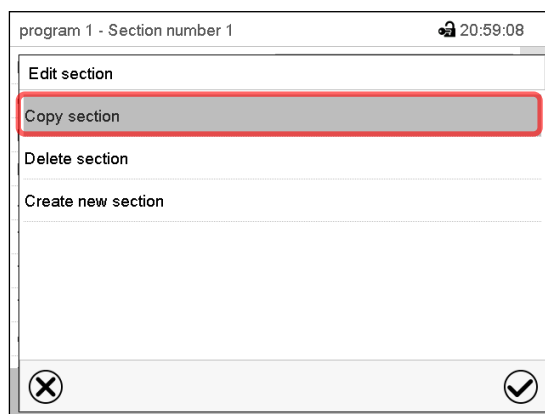

Section editor: "Edit section" menu

Select "Copy section" and press the **Confirm** icon.

The current section (example: section 1) is copied. The controller returns to the section view.

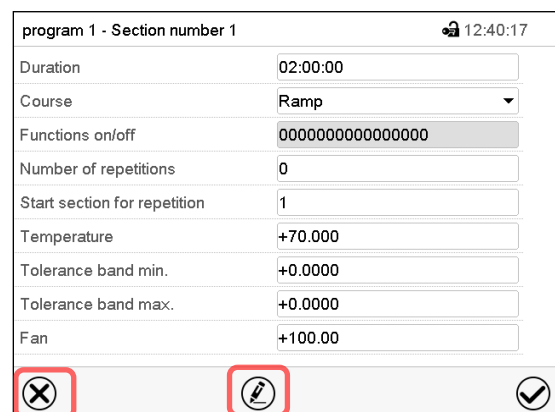

Section view (example: section 1).

Press the **Close** icon to change to the program view, if you want to select another section to be replaced or before or after which the copied section shall be inserted...



or

Press the **Edit** icon to open the section editor if you want the current section to be replaced or the copied section to be inserted before or after it

Programm 1 - Time program						🔒 14:03:27
No.	Duration [hh:mm:ss]	Temperature [°C]	Fan [%]	Air flap [ ]	---	---
1	02:00:00	70.000	100.00	4.0000	---	---
2	00:00:01	70.000	100.00	4.0000	---	---

Program view.

Select the section to be replaced or before or after which the copied section shall be inserted (example: section 2) and press the **Confirm** icon.

program 1 - Section number 1		🔒 12:40:17
Duration	02:00:00	
Course	Ramp	
Functions on/off	0000000000000000	
Number of repetitions	0	
Start section for repetition	1	
Temperature	+70.000	
Tolerance band min.	+0.0000	
Tolerance band max.	+0.0000	
Fan	+100.00	

Section view (example: section 1).

Press the **Edit** icon to open the section editor

program 1 - Section number 1		🔒 21:00:40
Edit section		
Copy section		
Replace section		
Insert section		
Delete section		
Create new section		

Section editor: "Edit section" menu

Select "Replace section" to replace the selected section with the copied section

or

Select "Insert section" to additionally add the copied section.

In this case select whether to insert it before or after the selected section.

Insert section	
before current section	
after current section	

Press the **Confirm** icon

### 10.6.3 Deleting a program section

In the **program view** select the program section to be deleted. The section view opens.



In the **section view** press the **Edit** icon to open the section editor



In the **section editor** select "Delete section" and press the **Confirm** icon.

The section is deleted. The controller returns to the section view.

## 10.7 Value entry for a program section

Path: [Main menu](#) > [Programs](#) > [Time program](#)

Select the desired program and section.

The section view gives access to all parameters of a program section. You can enter or modify the values.

	<table border="1"> <tr><th>Program name and section number</th></tr> <tr><td>Section duration</td></tr> <tr><td>Type of setpoint transition: ramp or step</td></tr> <tr><td>Operation lines</td></tr> <tr><td>Repeating one or several sections within a program</td></tr> <tr><td>Temperature setpoint</td></tr> <tr><td>Temperature tolerance range: minimum and maximum</td></tr> <tr><td>Fan speed</td></tr> <tr><td>Air flap</td></tr> </table>	Program name and section number	Section duration	Type of setpoint transition: ramp or step	Operation lines	Repeating one or several sections within a program	Temperature setpoint	Temperature tolerance range: minimum and maximum	Fan speed	Air flap
Program name and section number										
Section duration										
Type of setpoint transition: ramp or step										
Operation lines										
Repeating one or several sections within a program										
Temperature setpoint										
Temperature tolerance range: minimum and maximum										
Fan speed										
Air flap										

The setting and control ranges for the individual parameters are the same as for “Fixed value” operating mode (chap. 8).

### 10.7.1 Section duration

Section view (partial view).

Select the field “Duration” indicating the time.

“Duration” entry menu.

Enter the desired section duration with the arrow keys and press the **Confirm** icon.

Setting range: 0 up to 99 hours 59 min 59 sec.

## 10.7.2 Set-point ramp and set-point step

You can define the type of temperature transitions for each individual program section.

### “Ramp” mode: Gradual changes of temperature

The set-point of a given program section functions as the section’s start temperature. During the section’s duration, the set-point gradually passes to the set-point of the subsequent program section. The actual value follows the continually changing set-point.

If the last program section is in “ramp” mode and the setpoint shall change within this section, then you must program an additional section (with the shortest possible section duration) to provide the target temperature of the last program section. Otherwise, the setpoint would remain constant during the section’s duration.

Programming in the “ramp” mode allows all kinds of temperature transitions:

- Gradual changes of temperature  
The setpoint changes its value gradually during the entered section duration. The actual value follows the continually moving set-point at any time.
- Program sections with constant temperature  
The setpoints (initial values) of two subsequent program sections are identical; so, the temperature remains constant during the entire duration of the first program section.
- Sudden changes of temperature  
Steps can be programmed in ramp mode as temperature changes (ramps) that occur during a very short interval. If the duration of this transitional program section is very short (minimum entry 1 sec), the temperature change will proceed rapidly within the minimum amount of time.

### “Step” mode: Sudden changes of temperature

The set-point of any program section functions as the section’s target value. At the start of the program section, the unit heats up or cools down the chamber with the maximum speed to reach the entered value; and then it holds it for the remaining section time. Therefore, the set-point temperature remains constant for the section’s duration. These changes occur rapidly within the minimum amount of time (minimum entry: 1 second).

Programming in the “step” mode allows only two kinds of temperature transitions:

- Programming gradual changes of temperature (ramps) is impossible in the “step” mode
- Program sections with constant temperature  
The setpoints (target values) of two subsequent program sections are identical; so, the temperature remains constant during the entire duration of the first program section.
- Sudden changes of temperature  
The entered setpoint of the section is reached as fast as possible and then held constant for the remaining section duration.

### Selecting the setting “Ramp” or “Step”

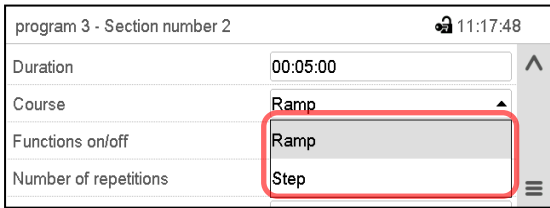

program 3 - Section number 2		🔒 11:17:48
Duration	00:05:00	⬆
Course	Ramp	⬆
Functions on/off	Ramp	
Number of repetitions	Step	☰

Section view (partial view).

In the field “Course” select the desired setting “Ramp” or “Step”.

### “Ramp” and “Step” mode example (representation of a temperature course)

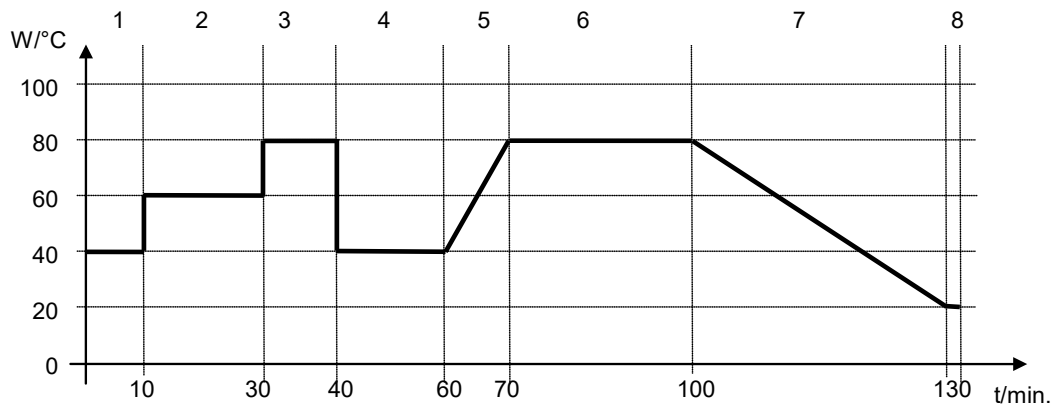

#### Corresponding program table

Section No.	Duration [hh:mm:ss]	Temperature [°C]	Fan [%]	Ramp or Step
1	00:10:00	40.0	xxxx	Step
2	00:20:00	60.0	xxxx	Step
3	00:10:00	80.0	xxxx	Step
4	00:20:00	40.0	xxxx	Step
5	00:10:00	40.0	xxxx	Ramp
6	00:30:00	80.0	xxxx	Ramp
7	00:30:00	80.0	xxxx	Ramp
8	00:00:01	20.0	xxxx	Ramp

### 10.7.3 Special controller functions via operation lines

You can define the switching state of up to 16 operation lines (control contacts). They are used to activate / deactivate special controller functions.

- Operation line “Idle mode” activates / deactivates the operating mode “Idle mode” (chap. 5.4). This mode serves to deactivate all chamber functions except the controller. With operating mode “Idle mode”, the heating and fan are deactivated.
- Operation line “Switching output” is used to switch on/off the zero-voltage switching contact
- Operation line “Object control” is used to switch on/off the object temperature control (option). This operation line is visible only at units with the object temperature control option.

The other operation lines are without function.

Use the setting “Functions on/off” to configure the operation lines.

program 1 - Section number 1 12:40:17

Duration 02:00:00

Course Ramp

Functions on/off 0000000000000000

Number of repetitions 0

Start section for repetition 1

Temperature +70.000

Tolerance band min. +0.0000

Tolerance band max. +0.0000

Fan +100.00

Section view.

Select the field "Functions on/off".

Functions on/off 13:11:13

Idle mode

Switching output

...

...

...

...

...

...

...

"Functions on/off" entry menu.

Mark / unmark the checkbox of the desired function to activate / deactivate it and press the **Confirm** icon.

The controller returns to the section view.

program 1 - Section number 1 12:32:12

Duration 02:00:00

Course Ramp

Functions on/off 0000000000000001

Number of repetitions 0

Start section for repetition 1

Temperature +70.000

Tolerance band min. +0.0000

Tolerance band max. +0.0000

Fan +100.00

Section view indicating the operation lines.

Activated operation line: switching status "1" (On)

Deactivated operation line: switching status "0" (Off)

The operation lines count from right to left.

**Example:**

Activated operation line "Idle mode" = 0000000000000001

Deactivated operation line "Idle mode" = 0000000000000000

**10.7.4 Setpoint entry for temperature and fan speed, setting the air flap position**

- Select the field "Temperature" and enter the desired temperature setpoint.  
Setting range: 0 °C up to 300 °C  
Confirm entry with **Confirm** icon. The controller returns to the section view.
- Select the field "Fan" and enter the desired fan speed setpoint.  
Setting range: 40% up to 100% fan speed.  
Confirm entry with **Confirm** icon. The controller returns to the section view.
- Select the field "Air flap" and enter the desired position „0“ up to „4“.  
Setting range: Position "0" (closed) to "4" (open).  
Confirm entry with **Confirm** icon. The controller returns to the section view.

### 10.7.5 Tolerance ranges

For temperature, you can specify a tolerance range for each program section with different values for the tolerance minimum and maximum. When the actual value exceeds the given threshold, the program is interrupted. This is indicated on the display (see below). When the actual temperature is situated again within the entered tolerance limits, the program automatically continues. Therefore, the duration of the program may be extended due to the programming of tolerances.



Programming of tolerances may extend program duration.

An entry of “-99999” for the tolerance minimum means “minus infinite” and an entry of “999999” for the tolerance maximum means “plus infinite”. Entry of these values will never lead to program interruption. The entry of “0” for the tolerance minimum and/or maximum deactivates the respective tolerance function.

When requesting rapid value transitions, we recommend not programming tolerance values in order to enable the maximum heating-up and cooling-down speed.

program 1 - Section number 1		🕒 12:40:17
Duration	<input type="text" value="02:00:00"/>	
Course	<input type="text" value="Ramp"/>	
Functions on/off	<input type="text" value="0000000000000000"/>	
Number of repetitions	<input type="text" value="0"/>	
Start section for repetition	<input type="text" value="1"/>	
Temperature	<input type="text" value="+70.000"/>	
Tolerance band min.	<input type="text" value="+0.0000"/>	
Tolerance band max.	<input type="text" value="+0.0000"/>	
Fan	<input type="text" value="+100.00"/>	

Section view, showing the temperature tolerance band.

- Select the field “Tolerance band min” and enter the desired lower tolerance band value. Setting range: -99999 to 99999. Confirm entry with **Confirm** icon. The controller returns to the section view.
- Select the field “Tolerance band max” and enter the desired upper tolerance band value. Setting range: -99999 to 99999. Confirm entry with **Confirm** icon. The controller returns to the section view.

If one of those actual values for which a tolerance range has been specified lies outside this program tolerance range the whole program course is interrupted. During this program interruption time the controller equilibrates to the set-points of the current section.

The screen header indicates “Program pause (tolerance band)”. The program runtime indication flashes and does not proceed any further.

When the corresponding actual values is back within the entered program tolerance range, the program continues automatically.

### 10.7.6 Repeating one or several sections within a time program

You can repeat several subsequent sections together. It is not possible to define the start section the same time also as the target section, therefore you cannot repeat a single individual section.

Enter the desired number of repetitions in the field “Number of repetitions” and the number of the section to start the repetition cycle with in the field “Start section for repetition” To have sections repeated infinitely, enter the number of repetitions as “-1”.

The selected sections are repeated as many times as selected. Then the program continues.

program 1 - Section number 1 🔒 12:40:17

Duration

Course

Functions on/off

**Number of repetitions**

**Start section for repetition**

Temperature

Tolerance band min.

Tolerance band max.

Fan

Section view, showing the repetition function.

- Select the field “Number of repetitions” and enter the desired number of repetitions. Setting range: 1 to 99, and -1 for infinite. Confirm entry with **Confirm** icon. The controller returns to the section view.
- Select the field “Start section for repetition” and enter the section number, at which the repetition should start. Setting range: 1 up to the section before the currently selected section. Confirm entry with **Confirm** icon. The controller returns to the section view.

### 10.7.7 Saving the time program

program 1 - Section number 1 🔒 12:40:17

Duration

Course

Functions on/off

Number of repetitions

Start section for repetition

Temperature

Tolerance band min.

Tolerance band max.

Fan

Section view.

After the all desired values of the program section have been configured, press the **Confirm** icon to take over the programming. The controller changes to the program view.



Programm 1 - Time program 🔒 14:03:27

No.	Duration [hh:mm:ss]	Temperature [°C]	Fan [%]	Air flap [ ]	---	---
1	02:00:00	70.000	100.00	4.0000	---	---
2	00:00:01	70.000	100.00	4.0000	---	---

Program view.

Press the **Confirm** icon to take over the programming. The controller changes to the Normal display.



To save the programming it is absolutely required to press the **Confirm** icon. Otherwise all settings will be lost! There is no confirmation prompt!

## 11. Week programs

The MB2 program controller permits programming week programs with real-time reference. It offers 5 week program places in total with up to 100 shift points for each week program.

Path: [Main menu](#) > [Programs](#) > [Week program](#)

### 11.1 Starting an existing week program

 In Normal display press the **Program start** icon to access the “Program start” menu.

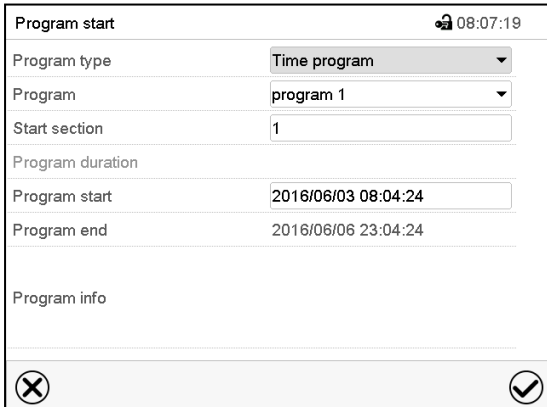

“Program start” menu.

- In the field “Program type” select the setting “Week program”.
- In the field “Program” select the desired program.
- There are no further settings available in the “Program start” menu for week programs, as they are needed only for time programs.

After completing the settings, press the **Confirm** icon to take over the entries and exit the menu. The program starts running.

If instead you press the **Close** icon to exit the menu without taking over the entries, the program will not start.

After starting the week program, the previously entered week program setpoints are active and will be equilibrated according to the current time.

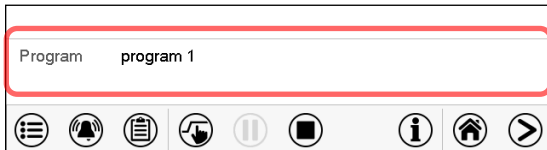

Information on the bottom of the screen indicates the currently running program.

### 11.2 Cancelling a running week program

 Press the **Program cancelling** icon to cancel the program.

A confirmation prompt is displayed. Press the **Confirm** icon to confirm that the program shall really be cancelled.

After confirming the message, the controller changes to Fixed value operation mode. Temperature and humidity will then equilibrate to the setpoints of Fixed value operation mode.



## 11.3 Creating a new week program

Path: [Main menu](#) > [Programs](#) > [Week program](#)

Week program	
No.	Program name
26	program 1
27	program 2
28	< empty >
29	< empty >
30	< empty >

“Week program” menu:  
overview of the existing programs.  
Select an empty program place.



Week program	
No.	Program name
26	program 1
27	program 2
28	< empty >
29	< empty >
30	< empty >

Program name	program1
Program info	<div style="border: 1px solid gray; height: 40px;"></div>
Course	Ramp



Enter the program name and, if desired, additional program information in the corresponding fields.

Select the set-point course “Ramp” or “Step” (chap. 11.6.1).

Press the **Confirm** icon.

The program view opens.

Program 1 - Week program					
No.	Weekday	Time [hh:mm:ss]	Temperature [°C]	Fan [%]	Air flap
1	No day	00:00:01	300.00	100.00	4.0000

Program view.

For the first section no weekday is specified. Therefore, the section is first marked in red and cannot be saved.

## 11.4 Program editor: program management

Path: [Main menu](#) > [Programs](#) > [Week program](#)

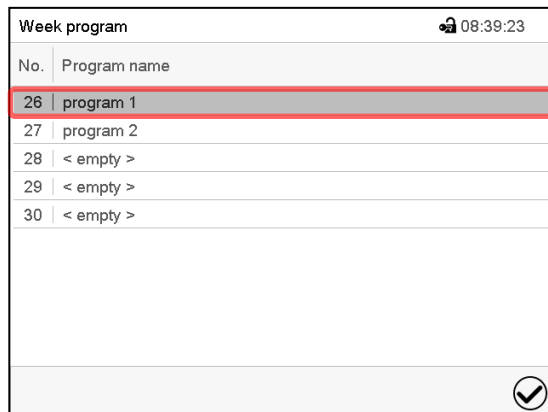

“Week program” menu: overview of the existing programs. Select an existing program (example: program 1).



No.	Weekday	Time [hh:mm:ss]	Temperature [°C]	Fan [%]	Air flap
1	Monday	00:06:00	70.000	100.00	4.0000
2	Tuesday	20:00:00	60.000	100.00	4.0000

Program view (example: program 1).

If a new program has been created, there is just one program section.

There are the following options:

- ① Select a program section to open the section editor (chap. 11.5)
- ② Press the **Edit** icon to open the program editor

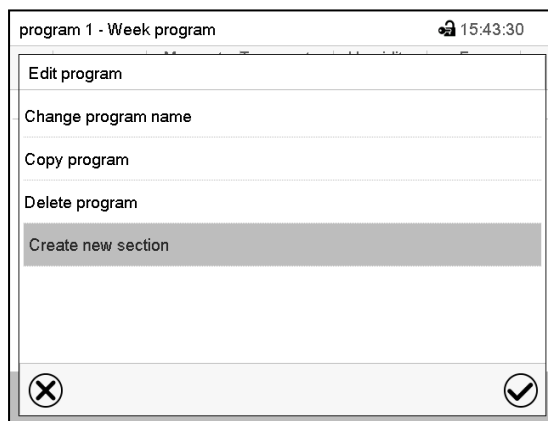

Program editor: “Edit program” menu.

Select the desired function and press the **Confirm** icon.

The program editor offers following options:

- Change program name. This menu also offers to configure the ramp / step mode setting (chap. 11.6.1).
- Copy program
- Replace program: Replacing a new or an existing program with the copied program. This menu point is visible only after a section has been copied.
- Delete program
- Create new section

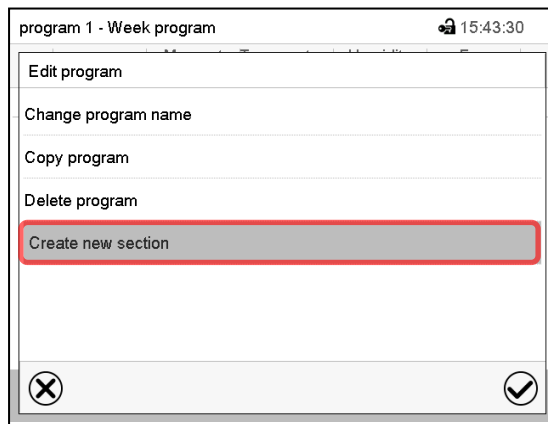

To add a new section, select “Create new section” and press the **Confirm** icon.  
The program view opens.

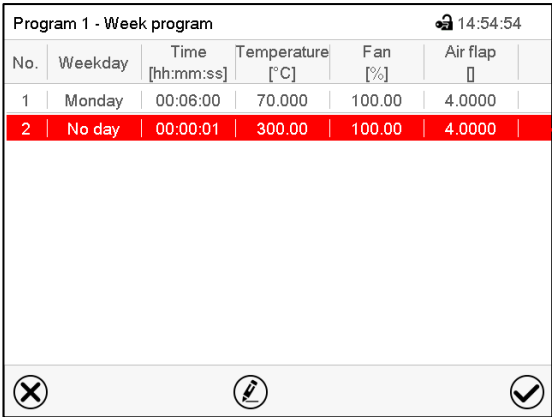

No.	Weekday	Time [hh:mm:ss]	Temperature [°C]	Fan [%]	Air flap []
1	Monday	00:06:00	70.000	100.00	4.0000
2	No day	00:00:01	300.00	100.00	4.0000

Program view.

With a new section no weekday is specified. Therefore, the section is first marked in red and cannot be saved.

A new section is always added at the very bottom (example: section 3). When the section start is specified the sections are automatically arranged in the correct chronological order.

#### 11.4.1 Deleting a week program

Path: [Main menu](#) > [Programs](#) > [Week program](#)

In the “Week program” menu select the program to be deleted. The program view opens.



In the **program view** press the **Edit** icon to open the program editor



In the **program editor** select “Delete program” and press the **Confirm** icon.  
The program is deleted. The controller returns to the program view.

## 11.5 Section editor: section management

Path: [Main menu](#) > [Programs](#) > [Week program](#)

Select the desired program.

No.	Weekday	Time [hh:mm:ss]	Temperature [°C]	Fan [%]	Air flap
1	Monday	00:06:00	70.000	100.00	4.0000
2	Tuesday	20:00:00	60.000	100.00	4.0000

Program 1 - Week program 17:09:21

Navigation icons: [Close] [Edit] [Confirm]

Program view.

Select the desired program section (example: section 1)



Program 1 - Section number 1 14:54:28

Weekday: Monday

Time: 00:06:00 ①

Temperature: +70.000 ①

Fan: +100.00

Air flap: +4.0000

Functions on/off: 0000000000000000

Navigation icons: [Close] [Edit] [Confirm]

Section view (example: section 1).

There are the following options:

- ① Select a parameter to enter or modify the according value (chap. 11.6)
- ② Press the **Edit icon** to open the program editor



program 1 - Section number 1 23:22:19

Edit section

Copy section

Delete section

Create new section

Navigation icons: [Close] [Confirm]

Section editor: "Edit section" menu

Select the desired function and press the **Confirm** icon.

The section editor offers following options:

- Copy section
- Replace section: Replacing an existing section with the copied section. This menu point is visible only after a section has been copied.
- Insert section: Adding the copied section. This menu point is visible only after a section has been copied.
- Delete section
- Create new section

### 11.5.1 Add a new program section

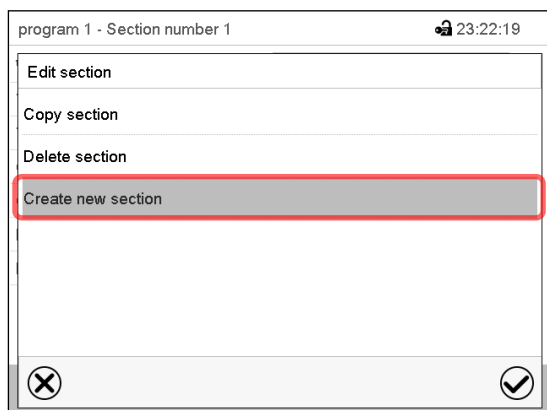

Section editor: "Edit section" menu.

Select "Create new section" and press the **Confirm** icon.

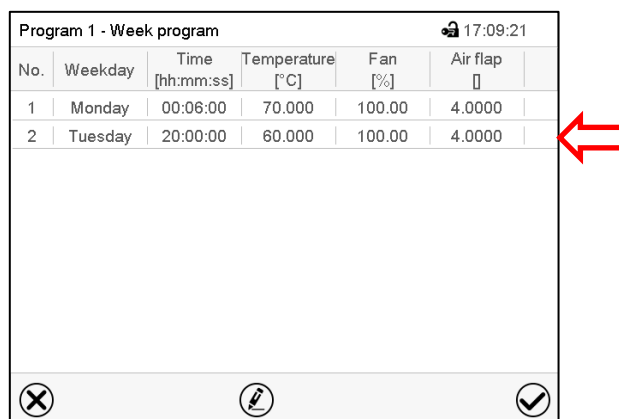

Program view.

With a new section no weekday is specified. Therefore, the section is first marked in red and cannot be saved.

A new section is always added at the very bottom (example: section 3). When the section start is specified the sections are automatically arranged in the correct chronological order.

### 11.5.2 Copy and insert or replace a program section

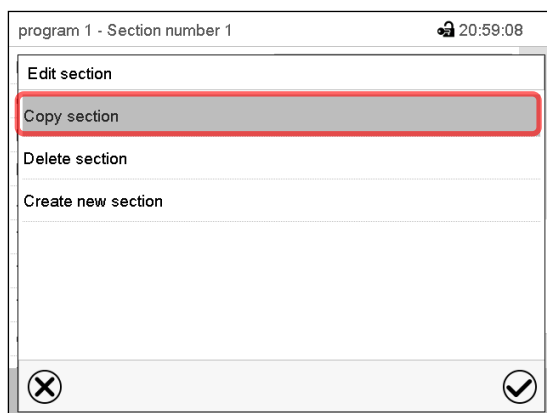

Section editor: "Edit section" menu

Select "Copy section" and press the **Confirm** icon.

The current section (example: section 1) is copied.

The controller returns to the program view.

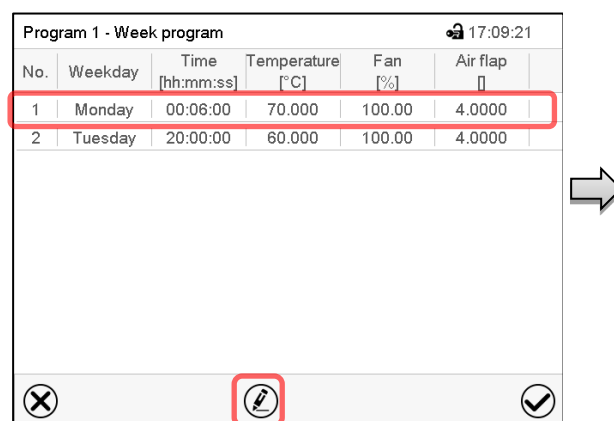

Program view

Select the section to be replaced or before or after which the copied section shall be inserted (example: section 1).

Press the **Confirm** icon

The controller returns to the section editor

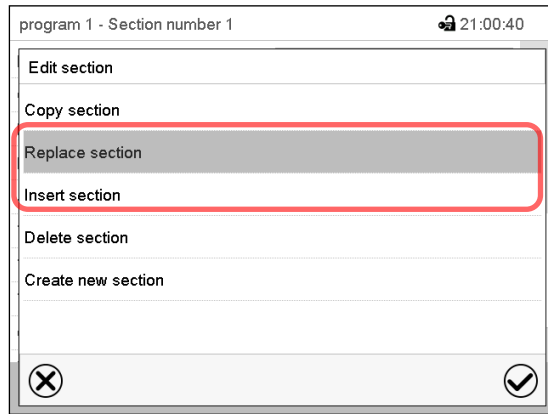

Section editor: “Edit section” menu

Select “Replace section” to replace the selected section with the copied section

or

Select “Insert section” to additionally add the copied section.

Press the **Confirm** icon.

If you selected “Insert section” the sections are automatically arranged in the correct chronological order.

### 11.5.3 Deleting a program section

In the **program view** select the program section to be deleted. The section view opens.



In the **section view** press the **Edit** icon to open the section editor



In the **section editor** select “Delete section” and press the **Confirm** icon.

The section is deleted. The controller returns to the section view.

## 11.6 Value entry for a program section

Path: [Main menu](#) > [Programs](#) > [Week program](#)

Select the desired program and section.

The setting and control ranges for the individual parameters are the same as for “Fixed value” operating mode (chap. 8).

### 11.6.1 Set-point ramp and set-point step modes

The explanation of the settings “Ramp” or “Step” is given in chap. 10.7.2.

You can define the type of temperature transitions for the entire week program.

Select the desired program and press the **Edit** icon to open the program editor. In the program editor select the “Change program name” function and press the **Confirm** icon.

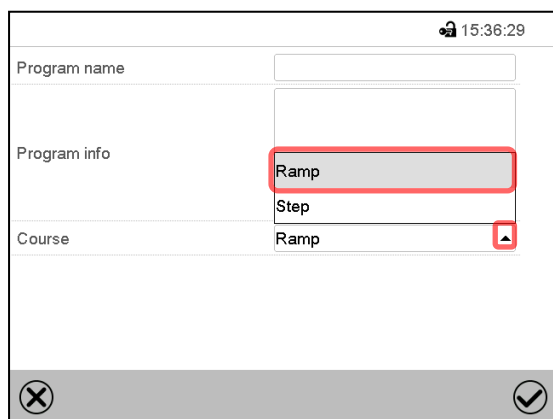

“Change program name” menu.

In the field “Course” select the desired setting “Ramp” or “Step” and press the **Confirm** icon.

### 11.6.2 Weekday

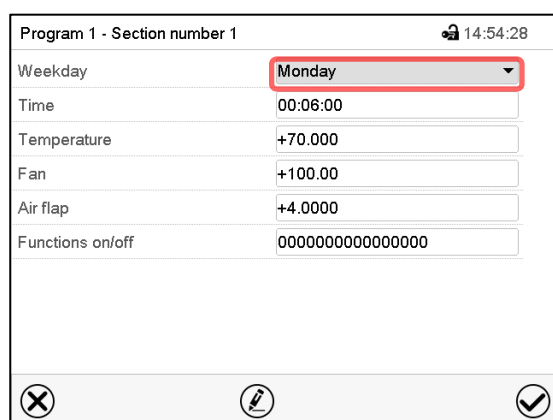

Section view.

In the field “Weekday” select the desired weekday.

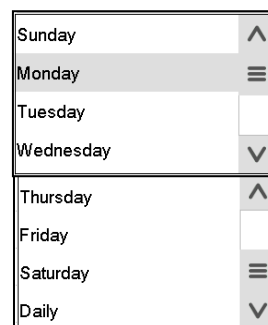

With “Daily” selected, this section will run every day at the same time.

### 11.6.3 Start time

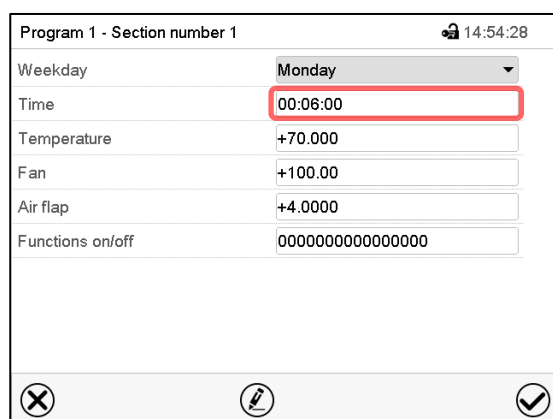

Section view.

Select the field “Moment”.

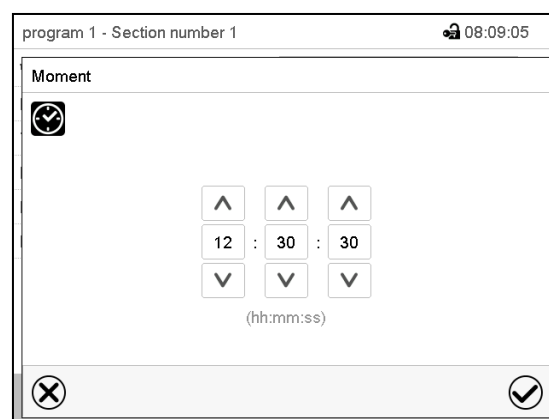

Entry menu “Moment”.

Select with the arrow keys the desired start moment of the section and press the **Confirm** icon.

#### 11.6.4 Setpoint entry for temperature and fan speed, setting the air flap position

- Select the field “Temperature” and enter the desired temperature setpoint.  
Setting range: 0 °C up to 300 °C  
Confirm entry with **Confirm** icon. The controller returns to the section view.
- Select the field “Fan” and enter the desired fan speed setpoint.  
Setting range: 40% up to 100% fan speed.  
Confirm entry with **Confirm** icon. The controller returns to the section view.
- Select the field “Air flap” and enter the desired position „0“ up to „4“.  
Setting range: Position “0” (closed) to “4” (open).  
Confirm entry with **Confirm** icon. The controller returns to the section view.

#### 11.6.5 Special controller functions via operation lines

You can define the switching state of up to 16 operation lines (control contacts). They are used to activate / deactivate special controller functions.

- Operation line “Idle mode” activates / deactivates the operating mode “Idle mode” (chap. 5.4). This mode serves to deactivate all chamber functions except the controller. With operating mode “Idle mode”, the heating and fan are deactivated.
- Operation line “Switching output” is used to switch on/off the zero-voltage switching contact
- Operation line “Object control” is used to switch on/off the object temperature control (option). This operation line is visible only at units with the object temperature control option.

The other operation lines are without function.

Select the desired program and section. You can set the operation lines in the “Functions on/off” field.

*For details please refer to chap. 10.7.3.*



## 12. Notification and alarm functions

### 12.1 Notification and alarm messages overview

#### 12.1.1 Notifications

Notifications are indicated by **information icons** displayed in the screen header in Normal display



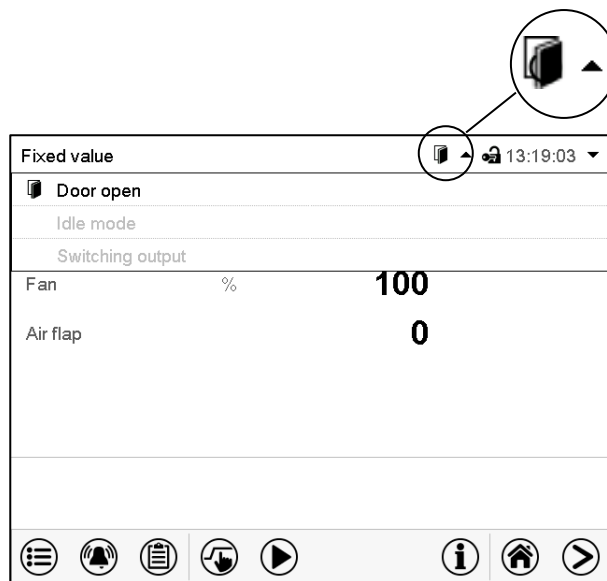

An information icon serves as an indication of a certain condition.

If this condition persists, in some cases an alarm will be triggered after a fix or configurable interval. As long as the condition persists, the information icon therefore continues to be displayed also in state of alarm. If during alarm the conditions ends, e.g., if during a tolerance range alarm the actual value returns to within the tolerance range, the information icon disappears, whereas the alarm will continue until manual acknowledgement.

Press the flash icon next to the information icon to access the corresponding text information.



Normal display showing the text information.  
The currently valid information texts are highlighted in black (example: "Door open")

Condition	Information icon	Text information	Start after condition occurred
The controller is in Idle mode (chap. 5.4).		"Idle mode"	immediately
The current actual temperature value is outside the tolerance range (chap. 12.4)		"Temperature range"	immediately
Chamber door open		"Door open"	immediately
Switching contact activated		"Switching output"	immediately
Object temperature control activated (option)		"Object control"	immediately

Notifications are not shown in the event list.

## 12.1.2 Alarm messages

Condition	Alarm message	Start after condition occurred	Zero-voltage relay alarm output (option)
The current actual temperature value is outside the tolerance range (chap. 12.4)	“Temperature range”	after configurable time (chap. 12.4)	time as alarm start
Open chamber door	“Door open	after 5 minutes	----
Power failure	---	----	immediately
Overtemperature protective device class 1 (thermal switch) activated	“Overtemperature”	immediately	immediately
Exceeded safety controller setpoint	“Safety controller	immediately	----
Regular temperature sensor defective. The FailSafe temperature sensor takes over the measurement (chap. 6)	“Sensor defective!”	immediately	immediately
Regular temperature and FailSafe temperature sensor defective (chap. 6)	Actual temperature value display shows “- - - -” or “<-<-< “ or “>->->”	immediately	immediately
FailSafe temperature sensor or safety controller temperature sensor defective	“Safety contr. class 3.1” or “Safety contr. class 2”, message not resettable		immediately

Alarm messages are displayed in the list of active alarms until acknowledging them. They are also shown in the event list.

## 12.2 State of alarm

1. Visual indications in Normal display: alarm message, screen header flashing in red color
2. Audible alert, if the buzzer is enabled (chap. 12.5).
3. Switching the zero-voltage relay alarm output (option, chap. 13.3) to transmit the alarm e.g., to a central monitoring system.

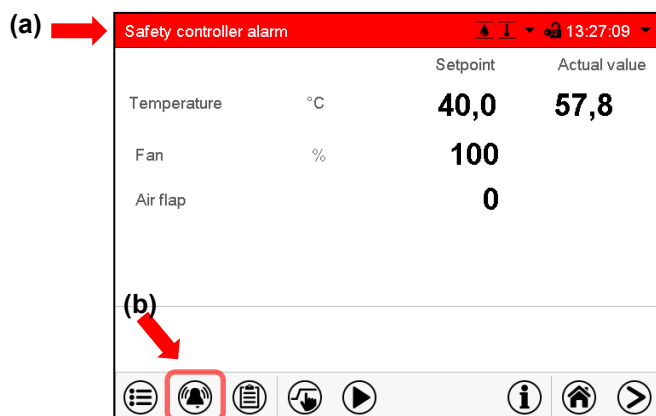

Normal display in state of alarm (example).

- (a) Screen header flashing in red color and showing the alarm message
- (b) **Alarm** icon on the bottom of the screen: change to the list of active alarms and alarm acknowledgement

## 12.3 Resetting an alarm, list of active alarms

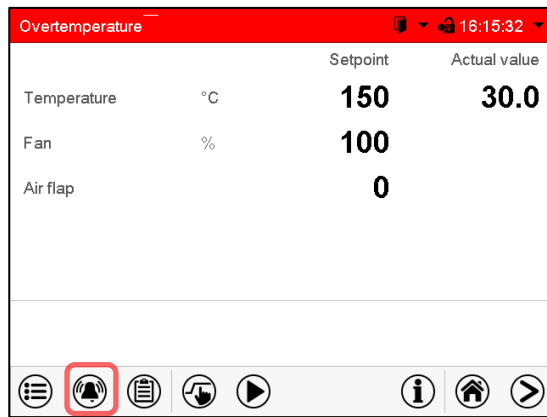

Normal display in state of alarm (example).

Press the **Alarm** icon

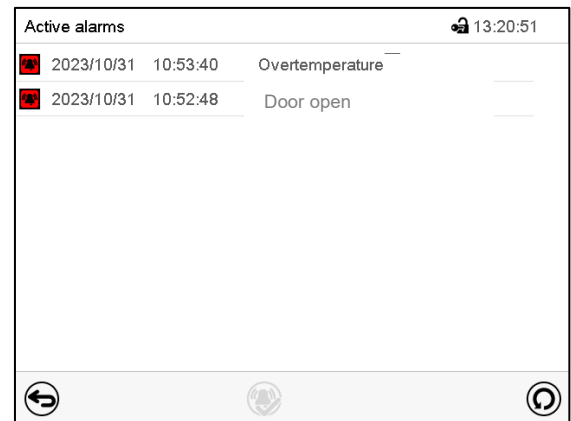

List of active alarms.

Press the **Reset alarm** icon.

Pressing the **Reset alarm** icon mutes the buzzer for all active alarms. The icon then disappears.

- Acknowledging while the alarm condition persists: Only the buzzer turns off. The visual alarm indication remains on the controller display. The alarm remains in the list of active alarms.

When the alarm condition has ended, the visual alarm indication is automatically cleared. The alarm is then no longer in the list of active alarms.

- Acknowledging after the alarm condition has ended: The buzzer and the visual alarm indication are reset together. The alarm is then no longer in the list of active alarms.
- The zero-voltage relay alarm output resets together with the alarm.

## 12.4 Tolerance range settings

In this menu you can set the deviation between the actual value and setpoint which shall cause a tolerance range alarm.

This function only activates after the set-point has been reached once.

Path: [Main menu](#) > [Settings](#) > [Various](#)

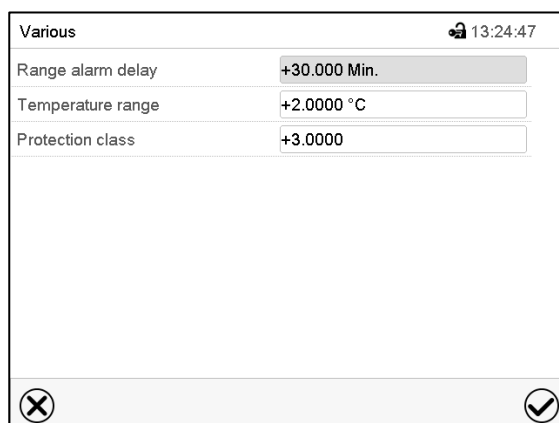

Submenu "Various".

- Select the field "Range alarm delay" and enter the time in minutes, after which the range alarm shall be triggered. Setting range: 15 min to 120 min. Confirm entry with **Confirm** icon.
- Select the field "Temperature range" and enter the desired value for the temperature range. Setting range: 2 °C to 20 °C. Confirm entry with **Confirm** icon.

After completing the settings, press the **Confirm** icon to take over the entries and exit the menu, **or** press the **Close** icon to exit the menu without taking over the entries.

If there are actual values outside the tolerance range the following information icons for the corresponding parameter are displayed:

Icon	Signification	Information
	"Temperature range"	The temperature value is outside the tolerance range

If the condition persists, an alarm is triggered after the configured interval ("range alarm delay"). It is visually indicated in Normal display. If the alarm buzzer is activated (chap. 12.5) there is an audible alert. The zero-voltage relay alarm output (option, chap. 13.3) switches to transmit the alarm. The alarm is shown in the list of active alarms (chap. 12.3).

## 12.5 Activating / deactivating the audible alarm (alarm buzzer)

Path: [Main menu](#) > [Settings](#) > [Chamber](#)

Chamber
🔒 13:28:37

Chamber name	M 56 (E3.1)
Language	English ▼
Language query after restart	Yes ▼
Temperature unit	Degrees Celsius ▼
Audible alarm	On ▼

⊗
✔

"Chamber" submenu (example).

In the field "Audible alarm" select the desired setting "off" or "on" and press the **Confirm** icon.

## 13. Overtemperature protection

### 13.1 Overtemperature protective device class 1

The chambers are regularly equipped with an overtemperature protective device (bimetallic switch) safety device class 1 acc. to DIN 12880:2007. It serves to protect the chamber, its environment and the contents against exceeding the maximum permissible temperature. When a defined cut-off temperature is reached, the overtemperature protective device turns off the heating.

#### Cut-off temperature values:

M 56: 330 °C / 626 °F

M 115, M 260, M 720: 350 °C / 662 °F

The message “Overtemperature” is displayed on the controller.

If the overtemperature protective device class 1 has turned off the heating, proceed as follows:

- Disconnect the controller from the power supply for at least 10 seconds (operating the on/off switch (4) or main power switch (11) or pull the power plug).
- If appropriate, have an expert examine and rectify the cause of the fault.
- Let the chamber cool down
- Restart the chamber.

As soon as the inner chamber temperature after restart is below the defined cut-off temperature of the overtemperature protective device class 1, the alarm message is deleted automatically.

#### 13.1.1 Message and measures in the state of alarm

The state of alarm is indicated visually and, if the buzzer is enabled (chap. 12.5) there is an additional audible alert (chap. 12.2). The heating turns off.

In the list of active alarms, a text message indicates the alarm cause. If the audible arm is activated, the buzzer sounds. Press the **Alarm** icon icon to mute the buzzer.

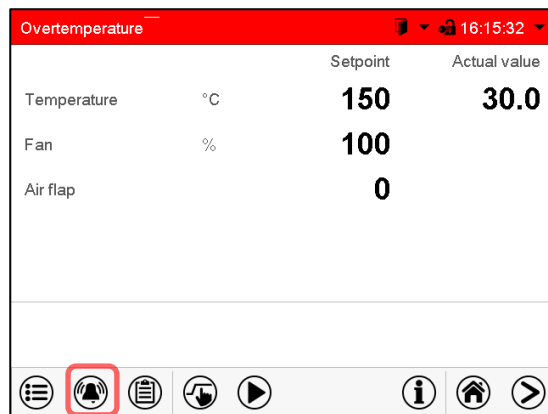

Normal display with overtemperature alarm.

Press the **Alarm** icon

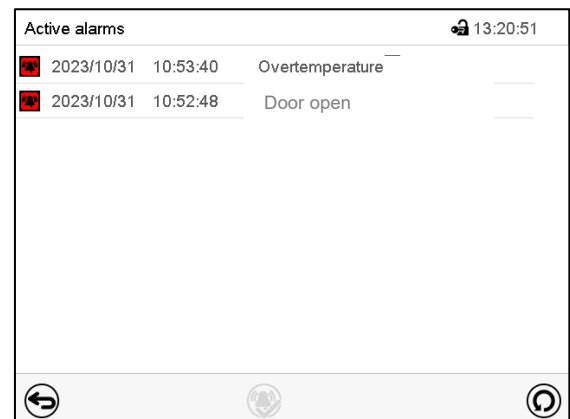

List of active alarms.

Press the **Reset alarm** icon.

The alarm message “Overtemperature” and the screen header flashing in red color keep displayed on the controller until pressing the **Alarm** icon icon **and** the alarm is reset (controller disconnected from the power supply for at least 10 seconds) **and** the inner temperature has fallen below the cut-off temperature value.

**Note:** When the overtemperature protective device class 1 has disconnected the heater you should disconnect the chamber from the power supply and have an expert examine and rectify the cause of the fault.

## 13.2 Overtemperature safety controller class 2 / 3.1

The chambers are regularly equipped with an adjustable electronic safety controller. It serves to protect the chamber, its environment and the contents against exceeding the maximum permissible temperature. Please observe the regulations applicable to your country (for Germany: DGUV guidelines 213-850 on safe working in laboratories, issued by the employers' liability insurance association).

Note: The function of the safety controller does not affect the function of the class 1 overtemperature protection device (bimetallic switch), as both are connected in series. Both signals are therefore required for the chamber to be operational.



Check the setting regularly and adjust it following changes of the set-point or load.

In the controller menu you can select between a safety controller class 2 ("temperature limiter") or class 3.1 ("temperature protection") acc. to DIN 12880:2007:

- The **safety controller class 2** must be acknowledged with the **Alarm** icon before the heating is switched on again.
- The **safety controller class 3.1**, on the other hand, switches the heating on again automatically when the temperature falls below the the selected safety controller set-point.

- **Safety controller class 2 ("temperature limiter")**

The safety controller class 2 limits the temperature inside the chamber to the entered safety controller set-point. In the event of a fault (if this maximum temperature is exceeded) the safety controller completely turns off the heating until manual reset.

This condition (state of alarm) is indicated visually and additionally with an audible alert if the buzzer is enabled (chap. 12.5). You can turn off the buzzer with the **Reset alarm** icon. The alarm persists until the chamber cools down below the configured safety controller value. The heating is only switched on again if the class 2 safety controller has been acknowledged with the **Reset alarm** icon.

If the safety controller class 2 has turned off the heating, we recommend proceeding as follows:

- Disconnect the chamber from the power supply.
- Have an expert examine and rectify the cause of the fault.
- Restart the chamber
- Reset the alarm message

- **Safety controller class 3.1 ("temperature protection")**

The safety controller class 3.1 limits the temperature inside the chamber to the entered safety controller set-point. In the event of a fault (if this maximum temperature is exceeded), it takes over the control to this value. This condition (state of alarm) is indicated visually and additionally with an audible alert if the buzzer is enabled (chap. 12.5).

The safety controller keeps control of the chamber until the chamber temperature cools down below the safety controller set-point value. When the chamber cools down below the configured safety controller value, the heating is activated again. You can then reset the alarm on the controller.

If the safety controller class 3.1 has taken over control, we recommend proceeding as follows:

- Disconnect the chamber from the power supply.
- Have an expert examine and rectify the cause of the fault.
- Restart the chamber
- Reset the alarm message

### 13.2.1 Selecting between safety controller class 2 (temperature limiter) or class 3.1

You have the option of operating the safety controller with class 2 or 3.1 functionality.

Path: [Main menu](#) > [Settings](#) > [Various](#)

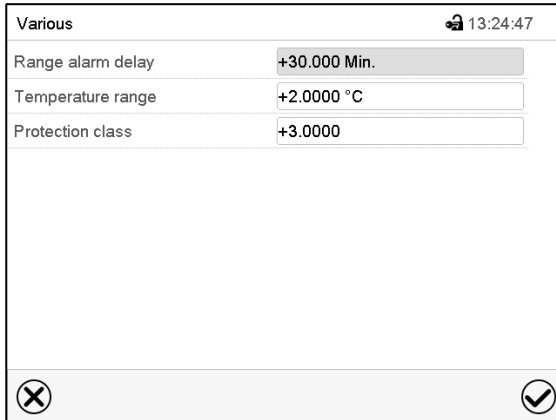

Submenu "Various".

- Select the field "Protection class" and enter the desired class: „2“ (Klasse 2) oder „3“ (Klasse 3.1). Factory setting: class 3. Confirm entry with **Confirm** icon.
- After completing the settings, press the **Confirm** icon to take over the entries and exit the menu, or press the **Close** icon to exit the menu without taking over the entries.

The functionality of the safety controller and the corresponding setting menus in the controller are adapted to the selection made here.

### 13.2.2 Safety controller mode

You can set the **safety controller mode** to "Limit (absolute)" or "Offset (relative)".

- **Limit:** Limit value, absolute maximum permitted temperature value  
This setting offers high safety as a defined temperature limit will not be exceeded. It is important to adapt the safety controller value after each modification of the temperature set-point. Otherwise, the limit could be too high to ensure efficient protection, or, in the opposite case, it could prevent the controller from reaching an entered set-point outside the limit range.
- **Offset:** Offset value, maximum overtemperature above any active temperature set point. The resulting maximum temperature changes internally and automatically with every temperature set-point change.  
This setting is recommended for program operation. It is important to check the safety controller set-point and safety controller mode occasionally, as it does not offer a fix, independent limit temperature value, which would never be exceeded.

#### Example:

Desired temperature value: 40 °C, desired safety controller value: 45 °C.

Possible settings for this example:

Temperature set point	Safety controller mode	Safety controller value
40 °C	Limit (absolute)	45 °C
	Offset (relative)	5 °C



Check the setting regularly and adjust it following changes of the set-point or charge.

### 13.2.3 Setting the safety controller

 Press the **Setpoint setting** icon to access the “Setpoint” setting menu from Normal display.

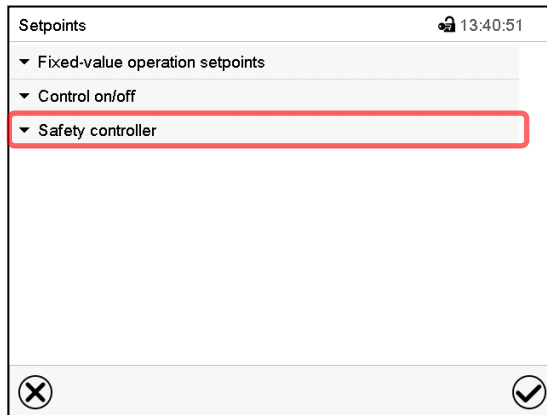

“Setpoints” menu.

Select the field “Safety controller” to access the settings.

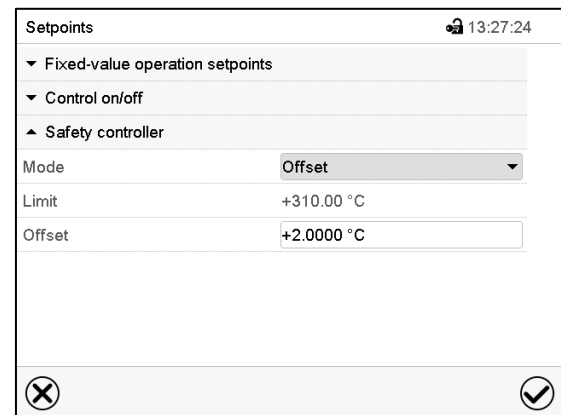

You can now set the safety controller mode and enter the safety controller value.

#### Setting the safety controller mode

- In the field “Mode” select the desired setting “Limit” or “Offset”.

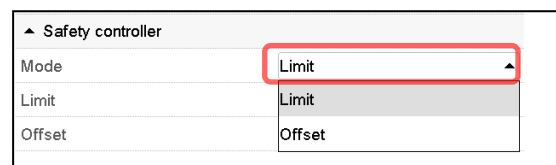

#### Setting the safety controller value

- Select the corresponding field “Limit” **or** “Offset” according to the selected mode and enter the desired safety controller setpoint. Confirm entry with **Confirm** icon.

 Regularly check the safety controller setting for set-point type “Limit” or “Offset”

- in Fixed value operating mode according to the entered set-point temperature value
- in program mode according to the highest temperature value of the selected temperature program

Set the safety controller set-point by approx. 2 °C to 5 °C above the desired temperature set-point.

After completing the settings, press the **Confirm** icon to take over the entries and exit the menu, **or** press the **Close** icon to exit the menu without taking over the entries.

### 13.2.4 Message and measures in the state of alarm

The state of alarm is indicated visually and, if the buzzer is enabled (chap. 12.5) there is an additional audible alert (chap. 12.2). The heating turns off. As soon as the inner chamber temperature has cooled down below the safety controller value, the heating can be released (class 2) or the heating is released (class 3.1), and temperature control continues.



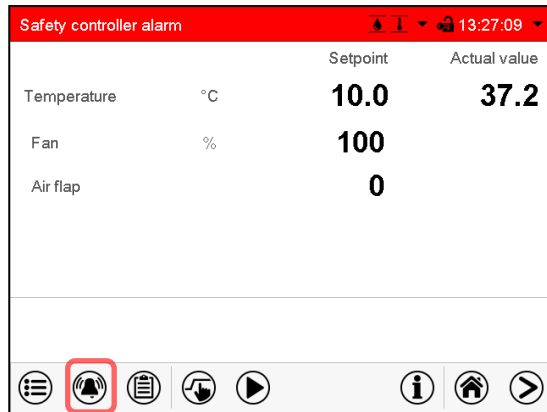

Normal display with safety controller alarm.

Press the **Alarm** icon

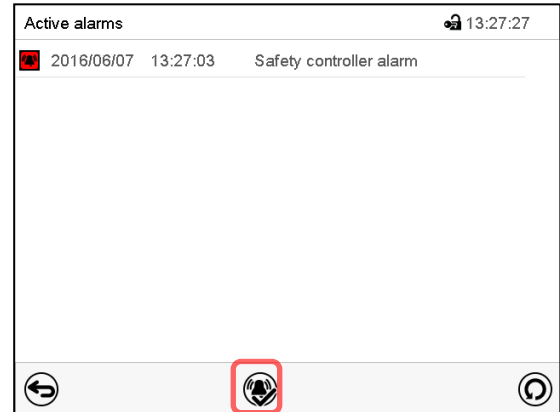

List of active alarms.

Press the **Reset alarm** icon.

In the list of active alarms a text message indicates the alarm cause. If the audible arm is activated, the buzzer sounds. Press the **Alarm** icon icon to mute the buzzer.

The alarm message “Safety controller alarm” and the red alarm message in the header are displayed on the controller until you press the **Alarm** icon icon on the controller **and** the inner chamber temperature has cooled down below the safety controller value.

- If the inner chamber temperature has already cooled down below the safety controller value when pressing the **Reset alarm** icon, the alarm message “Safety controller alarm” and the red alarm message are reset together with the buzzer.
- If the state of alarm is still active when pressing the **Reset alarm** icon, i.e. the inner chamber temperature is still above the safety controller value, first only the buzzer is reset. The alarm message “Safety controller” and the “Collective alarm” icon will disappear as soon as the inner chamber temperature falls below the safety controller value.

**Note:** When the safety controller had been activated you should disconnect the chamber from the power supply and have an expert examine and rectify the cause of the fault.

### 13.2.5 Function check

Check the safety controller at appropriate intervals for its functionality. It is recommended that the authorized operating personnel should perform such a check, e.g., before starting a longer work procedure.

### 13.3 Zero-voltage relay alarm contact

#### Collective alarm output via the zero-voltage relay alarm contact

The chamber is equipped at the rear with a zero-voltage relay **contact** (6), which permits the transmission of alarms generated by the chamber to an external monitoring system in order to monitor and record the alarm signals.

The connection is realized as 9-poles SUB-D socket “ALARM / SWITCH CONTACT” (6) as follows.

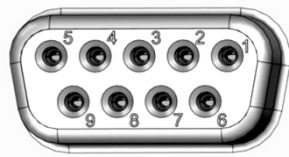

PIN 7 = C  
PIN 8 = NO  
PIN 9 = NC

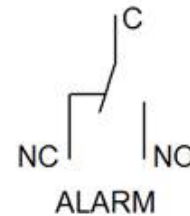

Figure 13: Pin configuration of the SUB-D socket “ALARM / SWITCH CONTACT” (6) for zero-voltage relay alarm contact



The zero-voltage relay alarm output switches immediately, as soon as the “Collective alarm” icon lights up. The zero-voltage relay alarm output switches for all alarm instances and in case of a power failure.

If the external alarm monitor is connected via the contacts C and NO, alarm monitoring will take place with protection against short-circuiting, i.e., if the connection between the chamber and the external alarm monitor is interrupted, an alarm is triggered. In this case, power failure will also trigger the alarm.

When the chamber is running and there is no alarm, contact C closes with contact NO.

When the chamber is turned off or if there is an active alarm, contact C closes with contact NC.

#### Maximum loading capacity of the switching contacts: 24V AC/DC – 2.0 Amp.

	 <b>DANGER</b>
	<p><b>Electrical hazard through overload of switching contacts.</b>  <b>Deadly electric shock, damage to switching contacts and connection socket.</b></p> <ul style="list-style-type: none"> <li>⊘ Do NOT exceed the maximum switching load of 24V AC/DC – 2.0 Amp.</li> <li>⊘ Do NOT connect any devices with a higher loading capacity.</li> </ul>

The alarm message on the controller display remains displayed during transmission of an alarm via the zero-voltage relay outputs. As soon as the cause of the alarm is rectified, or the alarm message has been reset, the alarm transmission via the zero-voltage relay outputs is reset together with the alarm message on the controller display.

In case of power failure, transmission of the alarm via zero-voltage relay outputs remains active for the duration of the power failure. Afterwards, the contact closes automatically.

#### Connection to an external monitoring system

To ensure short-circuit-proof alarm monitoring that will trigger the alarm when connected to an external alarm monitor, connect the external alarm monitoring system to the chamber via the connection socket (6) of the zero-voltage relay output.

## 14. User management

### 14.1 Authorization levels and password protection

The available functions depend on the current authorization level “Master”, “Service”, “Admin” or “User”.

The authorization levels are hierarchical: Every authorization includes all functions of the next lower level.

#### “Master” authorization level

- Highest authorization level, only for developers
- Extensive authorization for controller operation and configuration, outputs/inputs, alarm settings, parameter sets and operating ring display
- All passwords can be changed in the “log out” submenu (chap. 14.3).

#### “Service” authorization level

- Authorization level only for BINDER service
- Extensive authorization for controller operation and configuration, access to service data
- The passwords for “Service”, “Admin” and “User” authorization levels can be changed in the “log out” submenu (chap. 14.3).

#### “Admin” authorization level

- Expert authorization level, for the administrator
- Authorization for controller configuration and network settings and for operating those controller functions required for operating the chamber. Restricted access to service data.
- Password (factory setting): “2”.
- The passwords for “Admin” and “User” authorization levels can be changed in the “log out” submenu (chap. 14.3).

#### “User” authorization level

- Standard authorization level for the chamber operator
- Authorization for operating the controller functions required for operating the chamber.
- No authorization for controller configuration and network settings. The “Settings” and “Service” submenus of the main menu are not available.
- Password (factory setting): “1”
- The password for the “User” authorization level can be changed in the “log out” submenu (chap. 14.3).

As soon as a password has been assigned for an authorization level, the access to this level and the related controller functions are only available after log-in with the appropriate password.

If for an authorization level no password is assigned, the related controller functions of this level are available for every user without login.

If passwords have been assigned for all authorization levels, access to the controller functions is locked without login.

### Operation after user login

At user login, the authorization level is selected and confirmed by entering the respective password.

Following user login, controller operation is available, recognizable by the open-lock icon in the header. The available controller functions correspond to the user's authorization level.

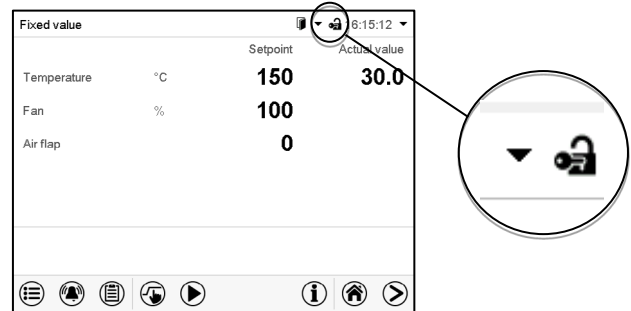

### Password protection activated for all levels: operation without user login is locked

If passwords have been assigned for all authorization levels, the controller is locked without registration of a user.

As long as no user is registered, controller operation is locked, recognizable at the closed-lock icon in the header. This requires that the user management has been activated by the assignment of passwords for the individual authorization levels.

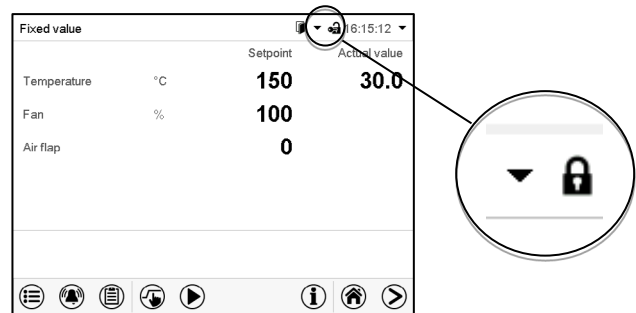

### Password protection for at least one level deactivated: operation without user login is possible

If passwords have not been assigned for all authorization levels, after turning on the chamber there are those controller functions available, which correspond to the highest authorization level without password protection.

No lock icon is shown in the display header.

User login is neither required nor possible.

To activate the password protection and user login, perform new password assignment (chap. 14.5.3).

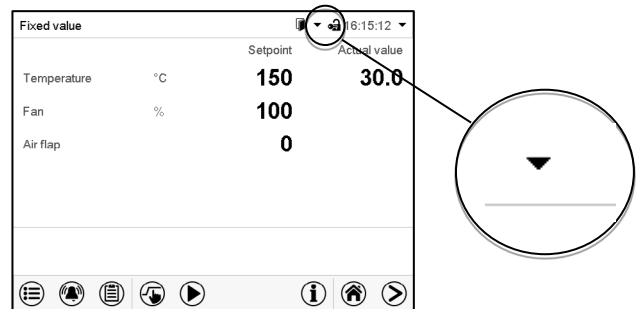

## Information window

To check the authorization level of the user currently logged-in, select in Normal display the arrow far right in the display header.

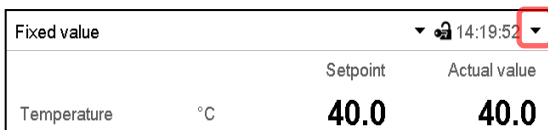

The information window shows date and time, the controller's free memory space and under "Authorization" the authorization level of the current user.

If passwords have been assigned for all authorization levels, a user without login (password entry) has no authorization. There are only viewing functions available.

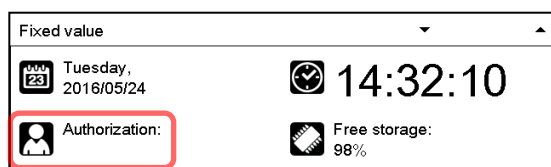

Display when all authorization levels are password protected and no user has logged in:  
No authorization level is displayed.

If passwords have been assigned only for some of the authorization levels, a user without login (password entry) has access to the functions of the highest authorization level without password protection.



Display when only some of the authorization levels are password protected (example: no protection for the "User" and "Admin" levels) and no user has logged in:

The user's effective authorization (due to lack of password protection) is shown.

Example: user with "Admin" authorization.

If passwords have been assigned for some or all of the authorization levels, user login (password entry) provides the authorization for the corresponding password-protected level.

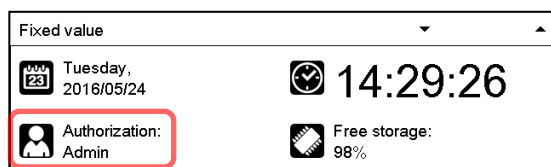

Display when at least some of the authorization levels are password protected and a user has logged in.

The user's authorization (by password entry) is shown.

Example: user with "Admin" authorization.

## 14.2 Log in

Path: **Main menu > User > Log in**

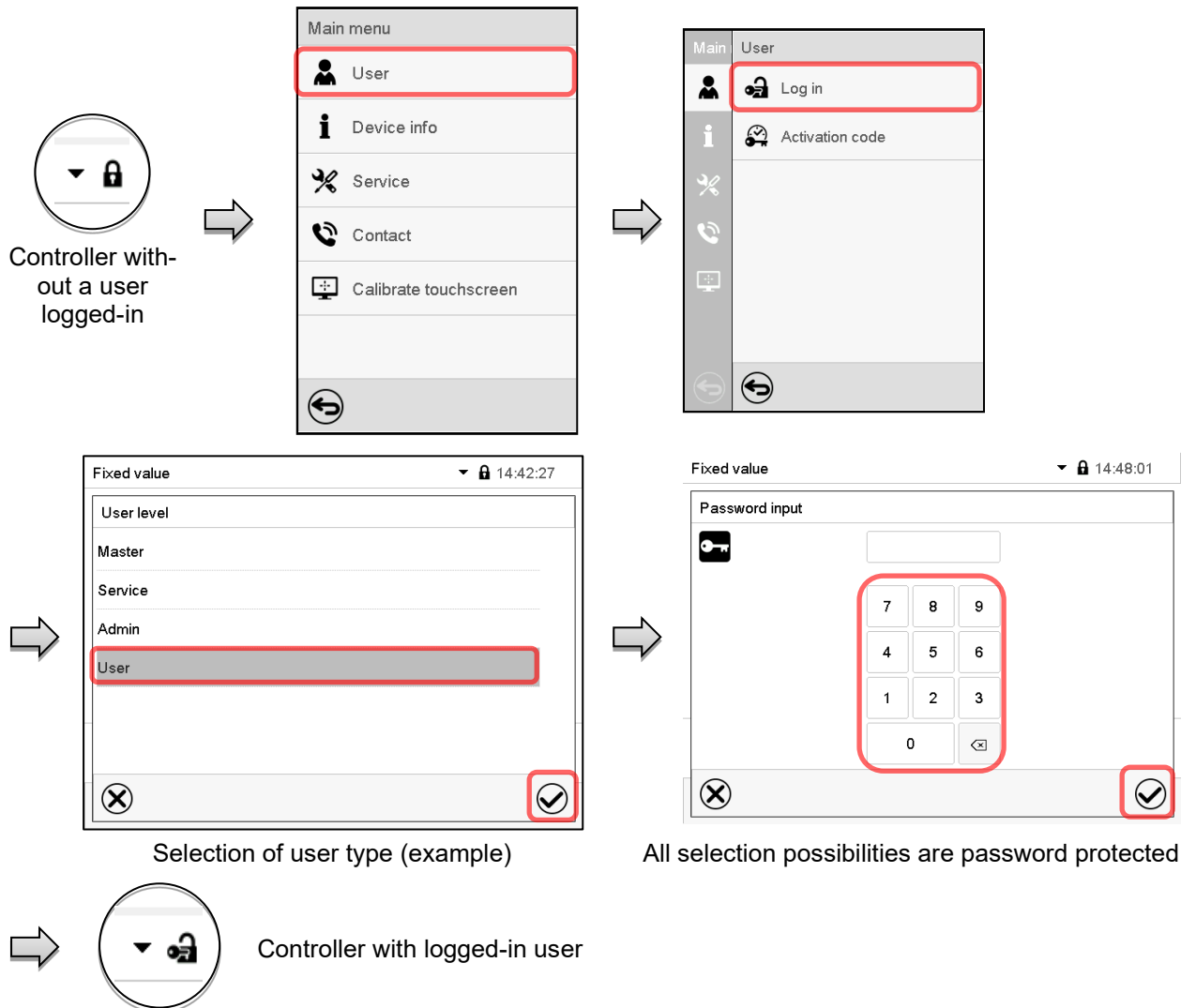

After completing the settings, press the **Confirm** icon to take over the entries and exit the menu, or press the **Close** icon to exit the menu without taking over the entries.

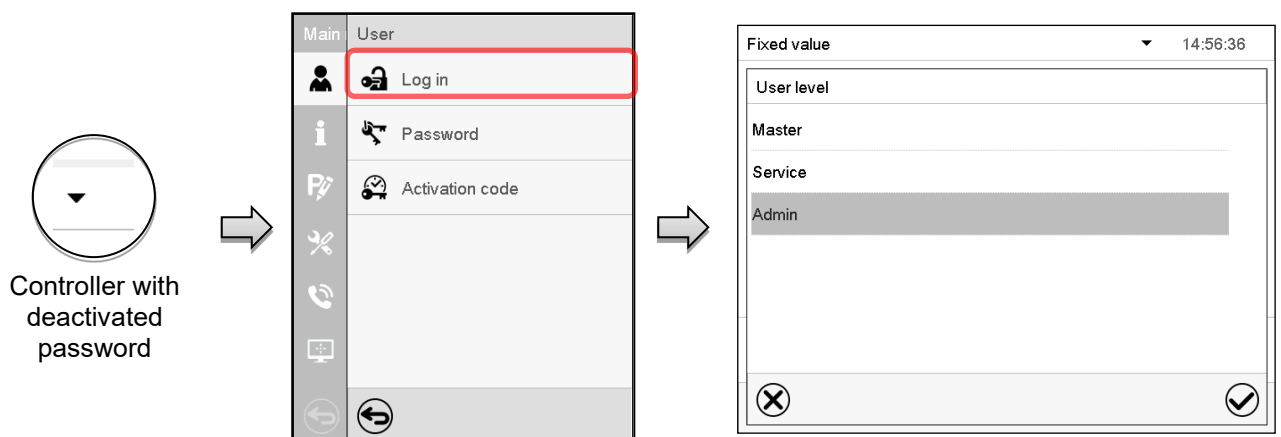

## 14.3 Log out

Path: [Main menu](#) > [User](#) > [Log out](#)

### User logoff with “Admin” authorization

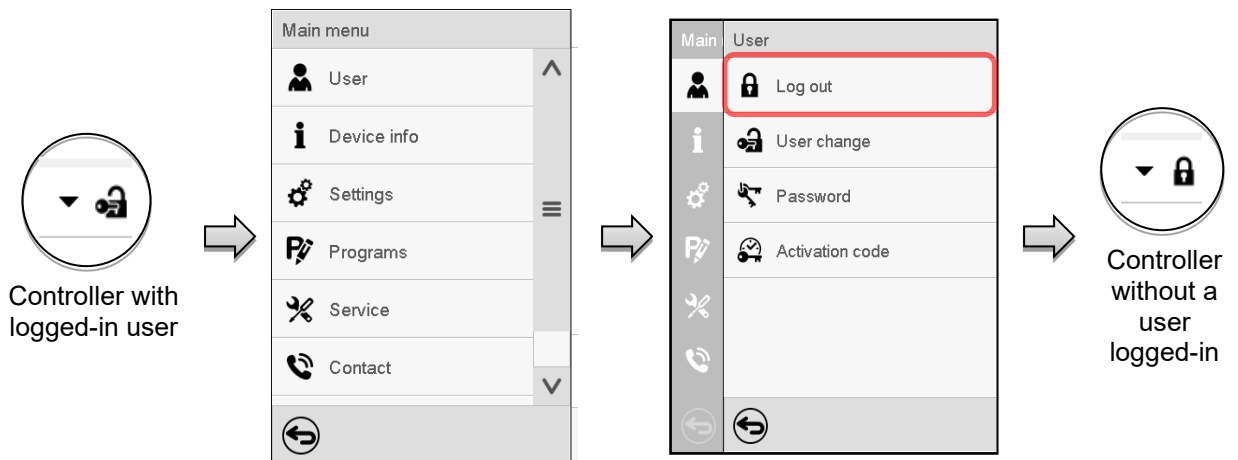

### User logoff with “User” authorization

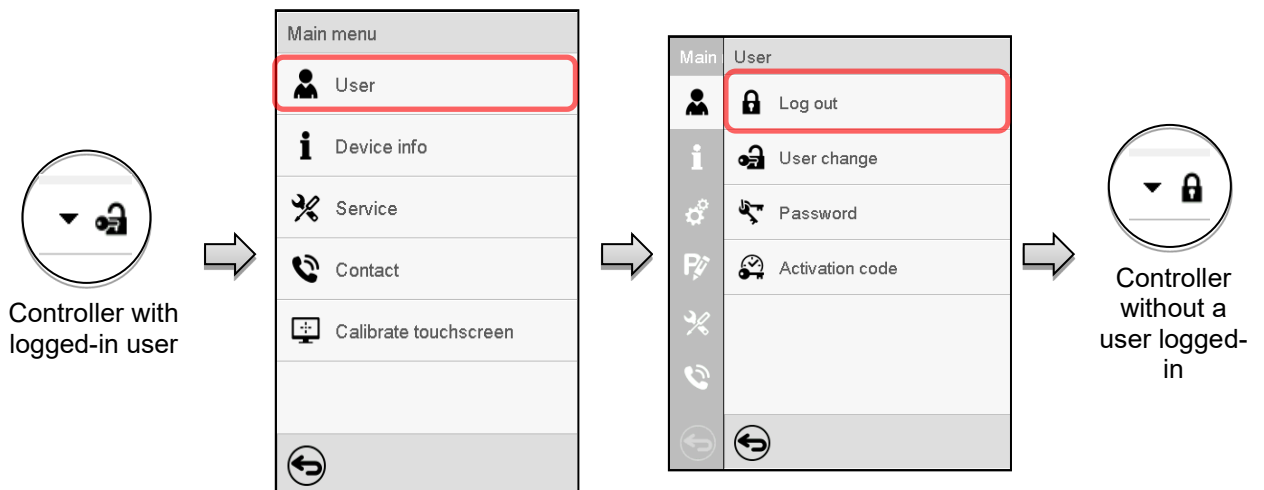

## 14.4 User change

If the password function has been deactivated (chap. 14.5.2) this function is not available.

Path: [Main menu](#) > [User](#) > [User change](#)

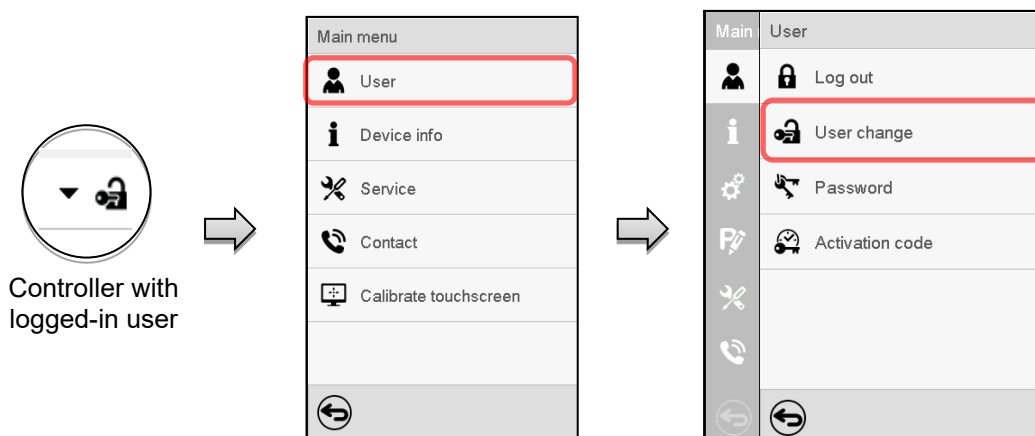



## 14.5 Password assignment and password change

This function is not available for a user logged-in with “User” authorization.

### 14.5.1 Password change

A logged-in user can change the passwords of his current level and of the next lower level(s).

**Example:** A user with “Admin” authorization can change the passwords for the “Admin” and “User” authorization levels.

Path: *Main menu > User > Password*

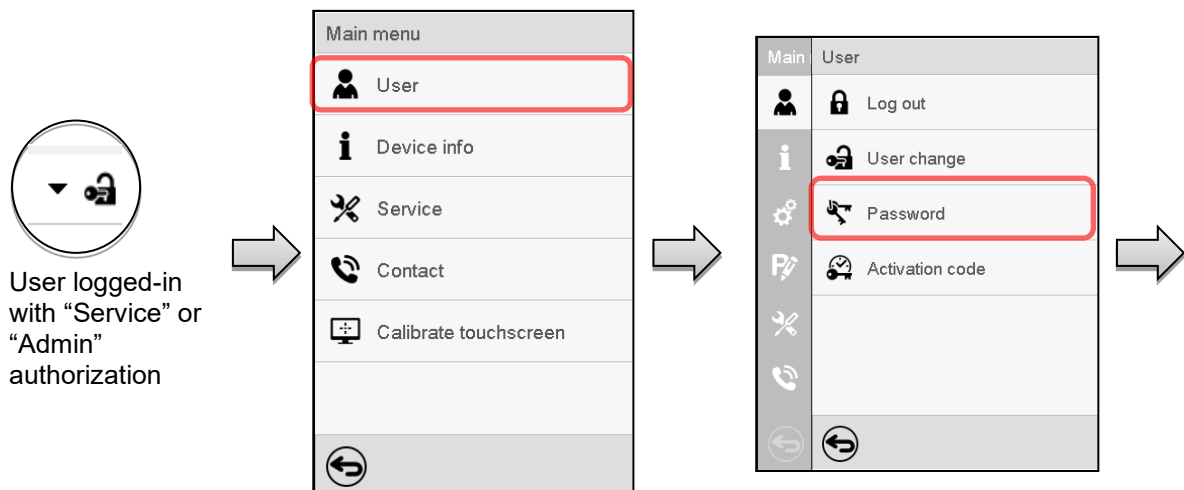



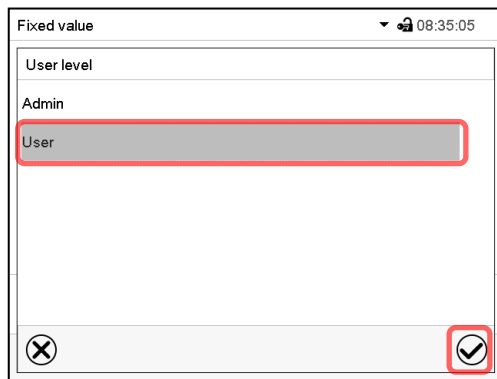

Selection of the authorization level  
(example: view with "Admin" authorization)

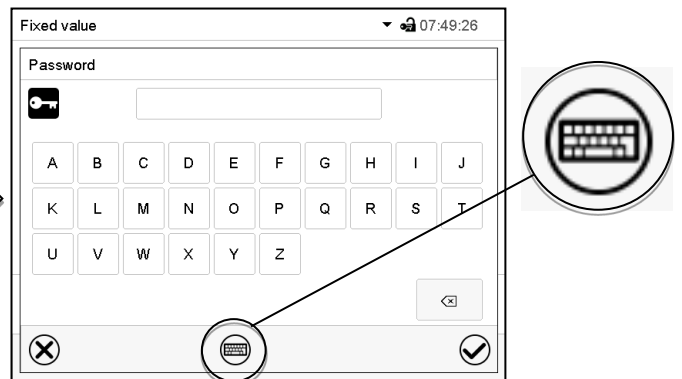

Enter desired password. If desired, press the **Change keyboard** icon to access other entry windows.

In the "Keyboard switch" window you can select different keyboards to enter uppercase and lowercase letters, digits, and special characters. All types of characters can be combined within one single password.

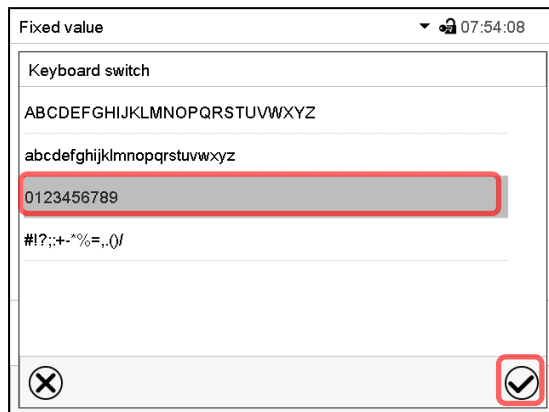

Example: access the digit entry window

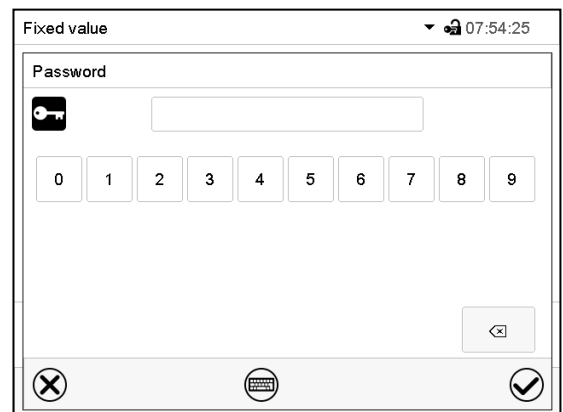

Entry of digits

To confirm the entry, press the **Confirm** icon.

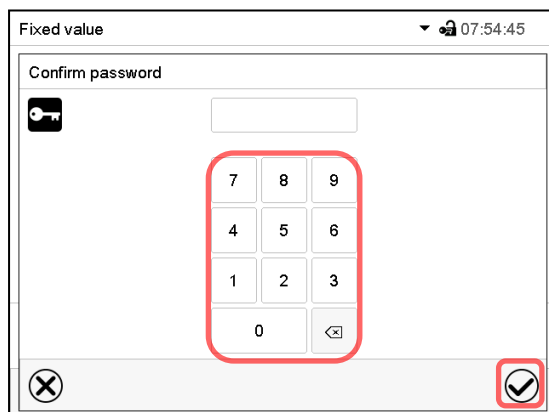

Repeat the password entry for confirmation (sample picture). For each character of the password, the required keyboard appears automatically.

Then press the **Confirm** icon.

## 14.5.2 Deleting the password for an individual authorization level

A user logged-in with “Service” or “Admin” authorization can delete the passwords of his current level and of the next lower level(s). To do this no password is entered during a password change.

Path: *Main menu > User > Password*



Controller with logged-in user (e.g. with “Admin” authorization)

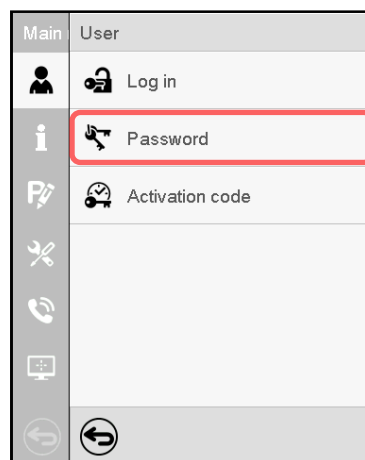
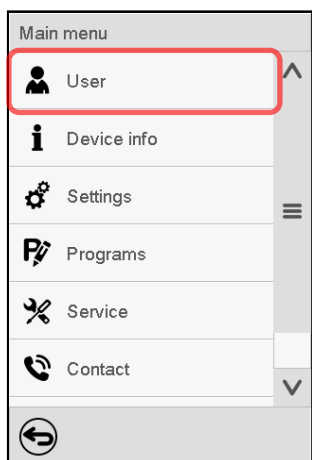

Select the authorization level for which the password shall be deleted.

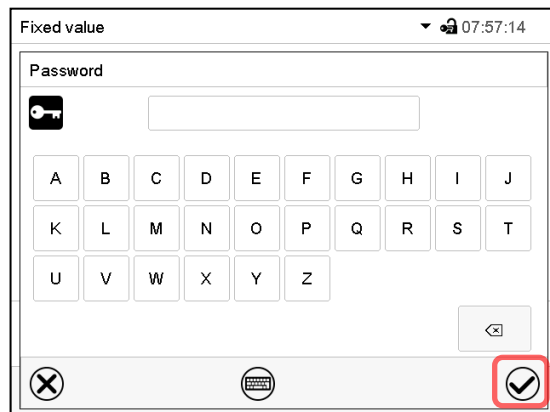

Do NOT enter anything in the “Password” screen. Press the **Confirm** icon.

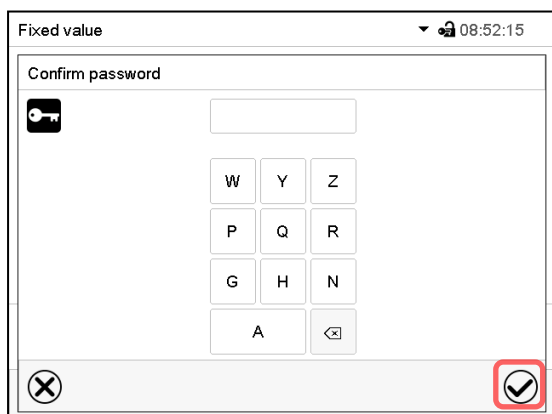

Do NOT enter anything in the “Confirm password” screen. Press the **Confirm** icon.

The password is deleted.

### 14.5.3 New password assignment for “service” or “admin” authorization level when the password function was deactivated

If the password protection for an authorization level has been deactivated, i.e., no password is assigned, no login for this level is possible. Therefore access to this authorization level is available without login.

If the password for the “Service” or “Admin” authorization has been deleted (chap. 14.5.2), a new password can be assigned for the current level and the next lower level(s) without user login.

**Example:** The password for the “Admin” authorization level was deleted, therefore every user without login has full access to the functions of the “Admin” authorization level. If access to this level shall become password protected again, the user can assign a new password for the “Admin” authorization level with the “Password” function.

Path: [Main menu](#) > [User](#) > [Password](#)

Controller with deactivated password for “Service” or “Admin” authorization

Main menu

- User
- Device info
- Settings
- Programs
- Service
- Contact

Main User

- Log in
- Password
- Activation code

Fixed value 08:59:54

User level

- Admin

Fixed value 07:57:14

Password

Enter the desired password. If desired, press the **Change keyboard** icon to access other entry windows.

To confirm the entry, press the **Confirm** icon.

Repeat the password entry for confirmation. For each character of the password, the required keyboard appears automatically. Then press the **Confirm** icon.

## 14.6 Activation code

Certain functions of the controller can be unlocked with a previously generated activation code.

The activation code enables access to functions available only in the “Service” authorization level by users without a “Service” authorization. Such functions include e.g., adjustment or extended configurations.

The activation code is available in authorization levels.

Path: [Main menu](#) > [User](#) > [Activation code](#)

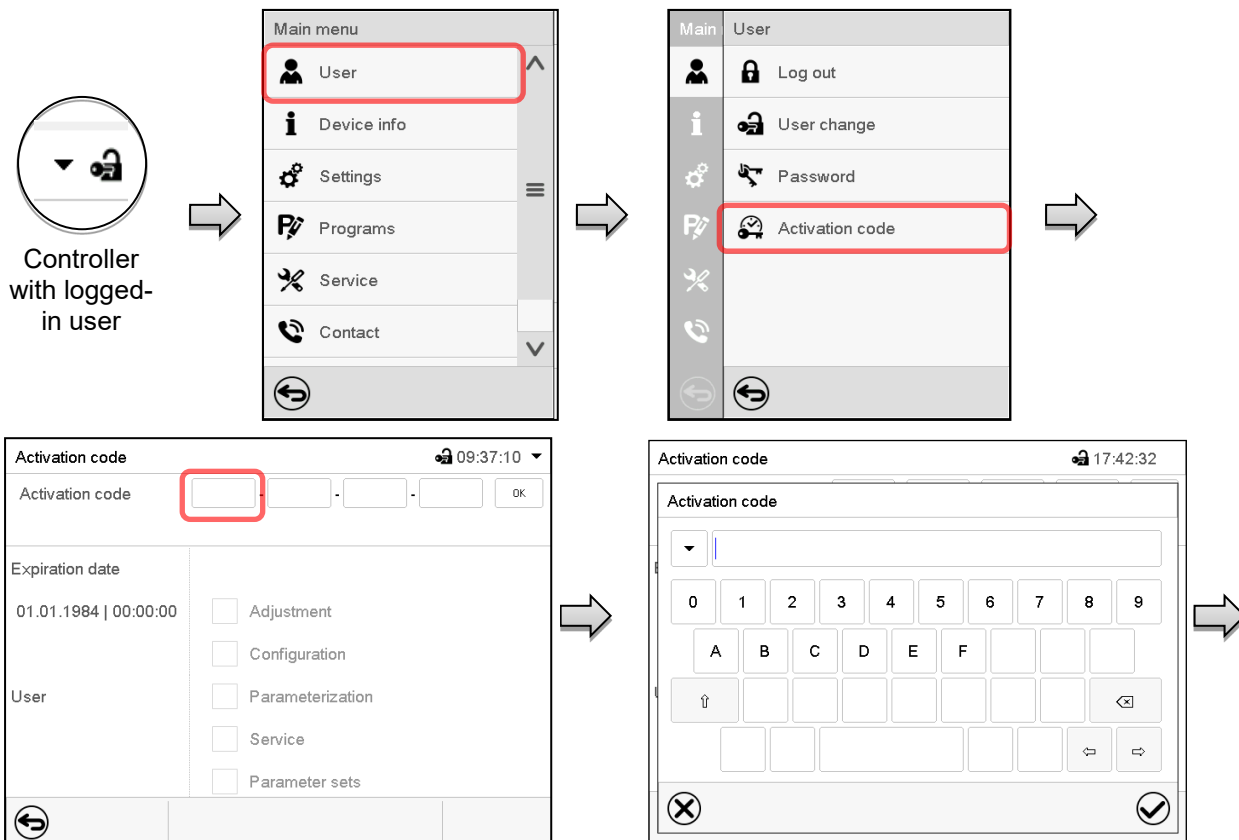

Activation code menu.

Select the first of the four entry fields.

Activation code entry window.

Enter the first four characters of the activation code and press the **Confirm** icon.

Select the next of the four entry fields and proceed accordingly until the entire code has been entered.

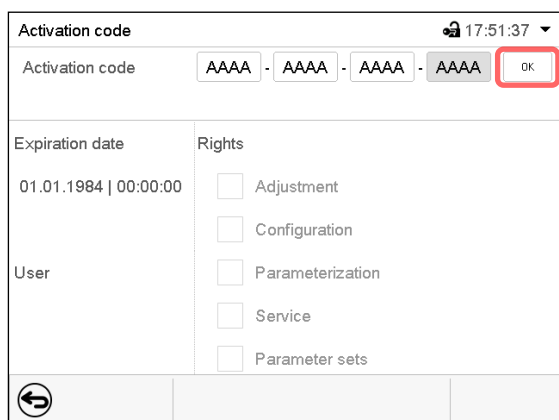

“Activation code” menu with entered code (sample view).

Press **OK** to take over the entry

The available functions are indicated by marked checkboxes.

Example: Extended configurations available.

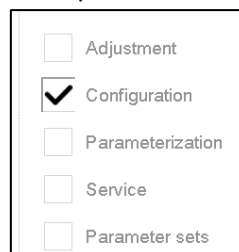

Under “Expiration date” the date of expiry of the code is displayed.

## 15. General controller settings

Most of the general settings can be accessed in the “Settings” submenu, which is available for users with “Service” or “Admin” authorization level. It serves to enter date and time, select the language for the controller menus and the desired temperature unit and to configure the controller’s communication functions.

### 15.1 Selecting the controller’s menu language

The MB2 program controller communicates by a menu guide using real words in German, English, French, Spanish, and Italian.

Path: [Main menu](#) > [Settings](#) > [Chamber](#)

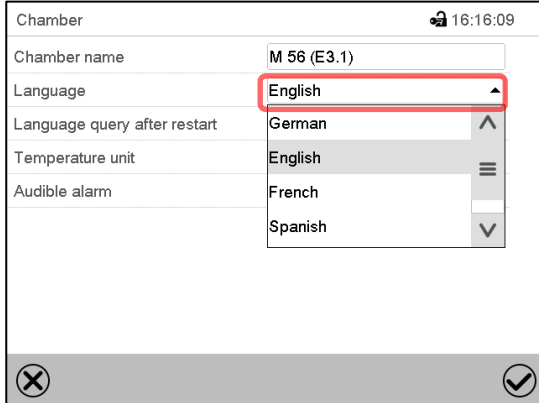

The screenshot shows the 'Chamber' submenu with a timestamp of 16:16:09. The 'Language' dropdown menu is open, and 'English' is highlighted. Other options visible are German, English, French, and Spanish. The 'Chamber name' is 'M 56 (E3.1)'. At the bottom, there are 'Back' (X) and 'Confirm' (checkmark) icons.

“Chamber” submenu (example).  
Select the desired language.

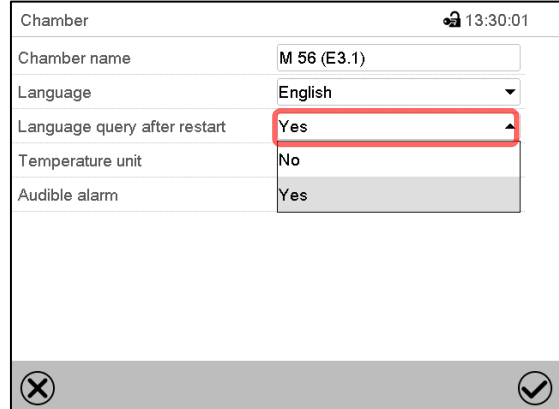

The screenshot shows the 'Chamber' submenu with a timestamp of 13:30:01. The 'Language query after restart' dropdown menu is open, and 'Yes' is highlighted. Other options visible are No and Yes. The 'Language' is set to 'English'. The 'Chamber name' is 'M 56 (E3.1)'. At the bottom, there are 'Back' (X) and 'Confirm' (checkmark) icons.

“Chamber” submenu (example).  
Select if there shall be a language query after restarting the chamber and press the **Confirm** icon.

Return to Normal display with the **Back** icon to take over the entries.

### 15.2 Setting date and time

Following start-up of the chamber after language selection:

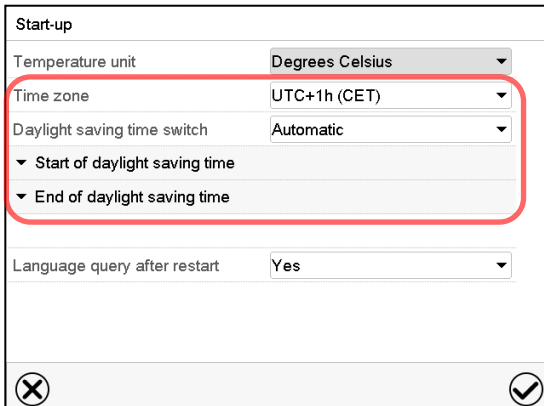

The screenshot shows the 'Start-up' submenu. The 'Time zone' dropdown is set to 'UTC+1h (CET)' and the 'Daylight saving time switch' dropdown is set to 'Automatic'. Below these are expandable sections for 'Start of daylight saving time' and 'End of daylight saving time'. The 'Language query after restart' is set to 'Yes'. The 'Temperature unit' is 'Degrees Celsius'. At the bottom, there are 'Back' (X) and 'Confirm' (checkmark) icons.

Select the time zone and configure the daylight-saving time switch.

Or later:

Path: [Main menu](#) > [Settings](#) > [Date and time](#)

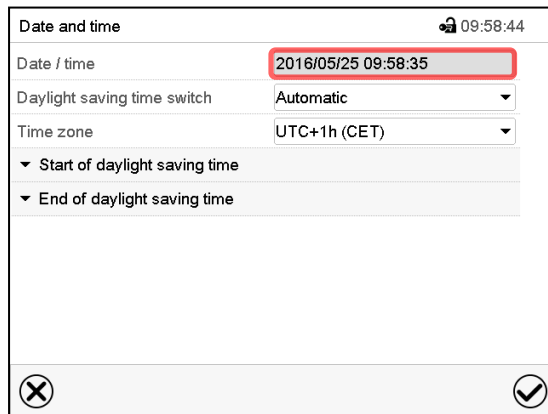

“Date and time” submenu.  
Select the field “Date / time”.

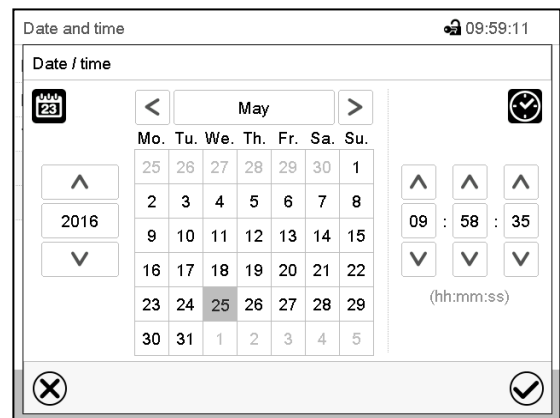

“Date / time” entry menu.  
Enter date and time and press the **Confirm** icon.

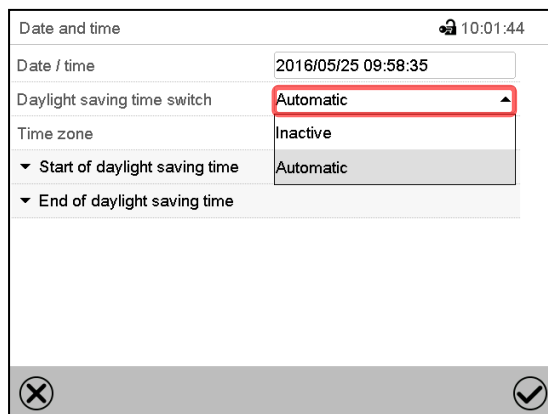

“Date and time” submenu.  
In the field “Daylight saving time switch” select the desired setting “Automatic” or “Inactive”.

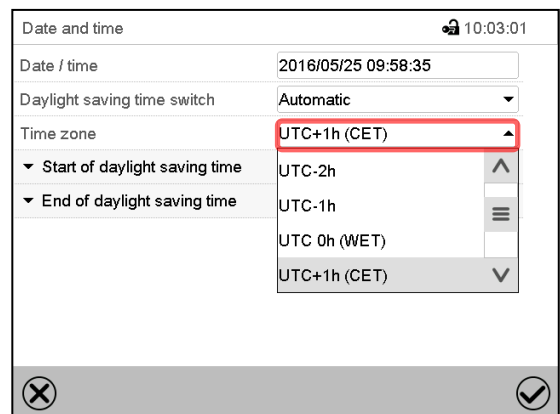

“Date and time” submenu.  
Select the desired time zone and press the **Confirm** icon.

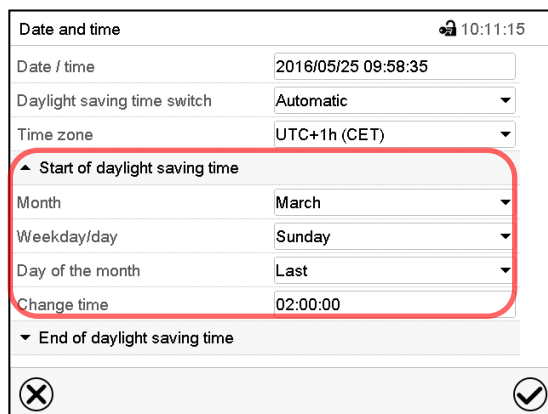

“Date and time” submenu.  
Select the desired start of the daylight-saving time.

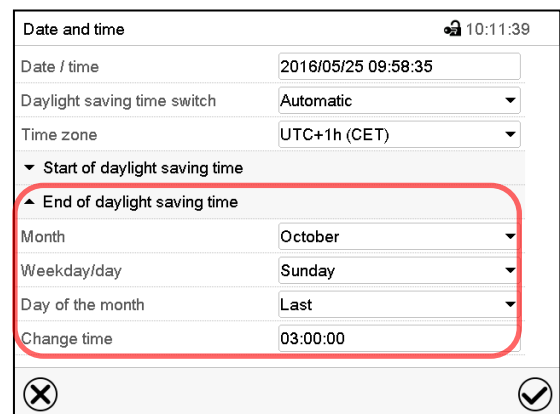

“Date and time” submenu.  
Select the desired end of the daylight-saving time and press the **Confirm** icon.

After completing the settings, press the **Confirm** icon to take over the entries and exit the menu, **or** press the **Close** icon to exit the menu without taking over the entries.

## 15.3 Selecting the temperature unit

Following start-up of the chamber:

Or later:

Path: [Main menu](#) > [Settings](#) > [Chamber](#)

Select the desired temperature unit and press the **Confirm** icon.

Change of the temperature unit between °C and °F.

If the unit is changed, all values are converted accordingly

	C = degree Celsius	0 °C = 32 °F	Conversion: [value in °F] = [value in °C] * 1,8 + 32
	F = degree Fahrenheit	100 °C = 212 °F	

## 15.4 Display configuration

### 15.4.1 Adapting the display parameters

This function serves to configure parameters like display brightness and operating times.

Path: [Main menu](#) > [Settings](#) > [Display](#) > [Display](#)

- “Display” submenu.

- Select the field “Brightness”.
- Move the grey slide to the left or right to define the brightness of the display
- left = darker (minimum value: 0)
  - right = brighter (maximum value: 100)
- Press the **Confirm** icon.



- Select the field “Wait time for screen saver” and enter the desired waiting time for the screen saver in seconds. Setting range: 10 sec up to 32767 sec. During the waiting time the display is off. Confirm entry with **Confirm** icon.
- In the field “Activate continuous operation” select the desired setting “Yes” or “No”.

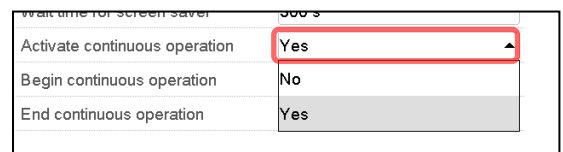

- Select the field “Begin continuous operation” (possible only if continuous operation is activated) and enter the time with the arrow keys. Confirm entry with **Confirm** icon.
- Select the field “End continuous operation. (only possible if continuous operation is activated) and enter the time with the arrow keys. Confirm entry with **Confirm** icon.

After completing the settings, press the **Confirm** icon to take over the entries and exit the menu, **or** press the **Close** icon to exit the menu without taking over the entries.

## 15.4.2 Touchscreen calibration

This function serves to optimize the display for the user’s individual angular perspective.

Path: [Main menu](#) > [Calibrate touchscreen](#)

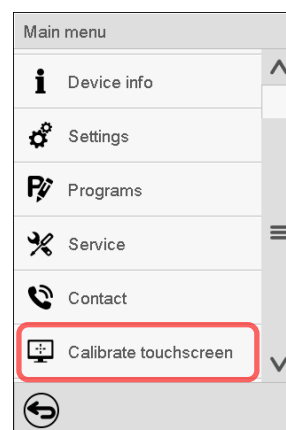
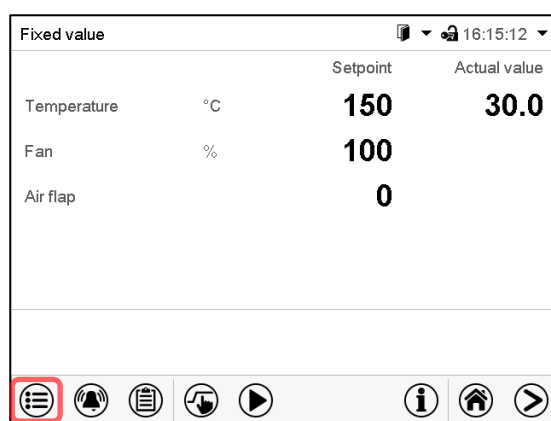

Normal display.

Select “Calibrate touchscreen” and follow the instructions on the display.

You need to touch all four corners of the touchscreen to calibrate it. Appropriate boxes appear successively in each corner.



	<p>The waiting icon shows how much time there is left to touch the currently activated box. If the box is not touched within this period, calibration is aborted and the display changes to Normal display.</p>
---	---

After completing the calibration, i.e., touching all four boxes, the display changes to Normal display.

## 15.5 Network and communication

For these settings at least the “Admin” authorization level is required.

### 15.5.1 Ethernet

#### 15.5.1.1 Configuration

Path: [Main menu](#) > [Settings](#) > [Ethernet](#)

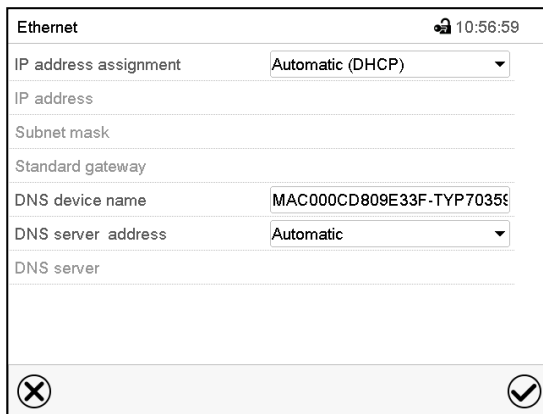

“Ethernet” submenu.

- In the field “IP address assignment” select the desired setting “Automatic (DHCP)” or “Manual”.

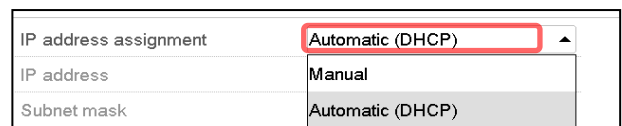

With selection “Manual” you can enter the IP-address, the subnet mask and the standard gateway manually.

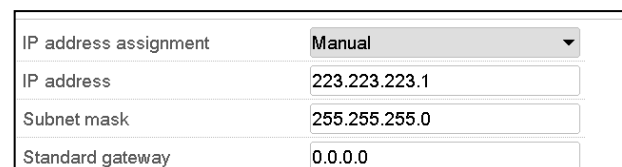

- Select “DNS device name” and enter the DNS device name. Confirm entry with **Confirm** icon.
- In the field “DNS server address” select the desired setting “Automatic” or “Manual”.

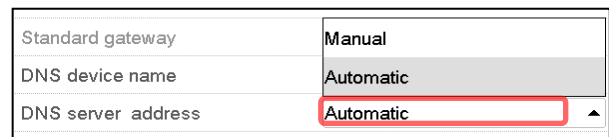

With selection “Manual” you can enter the DNS server address manually.

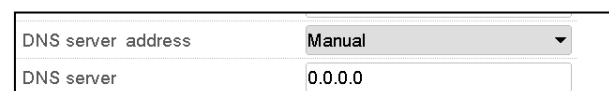

After completing the settings, press the **Confirm** icon to take over the entries and exit the menu, **or** press the **Close** icon to exit the menu without taking over the entries.

### 15.5.1.2 Display of the MAC address

Path: [Main menu](#) > [Device info](#) > [Ethernet](#)

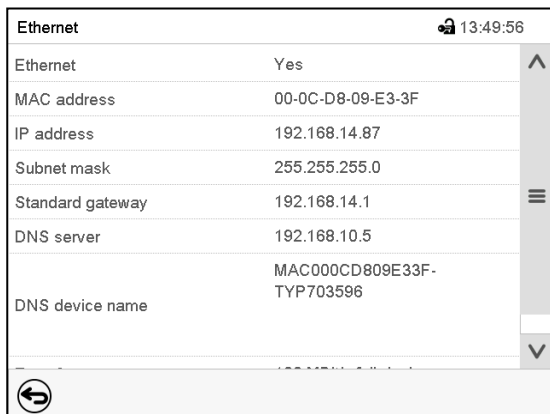

Ethernet		🔒 13:49:56
Ethernet	Yes	^
MAC address	00-0C-D8-09-E3-3F	
IP address	192.168.14.87	
Subnet mask	255.255.255.0	
Standard gateway	192.168.14.1	☰
DNS server	192.168.10.5	
DNS device name	MAC000CD809E33F-TYP703596	
		∇

“Ethernet” submenu (example values).

### 15.5.2 E-Mail

As soon as an alarm was triggered, an e-mail is sent to the configured e-mail address.

Path: [Main menu](#) > [Settings](#) > [Email](#)

#### E-mail address entry:

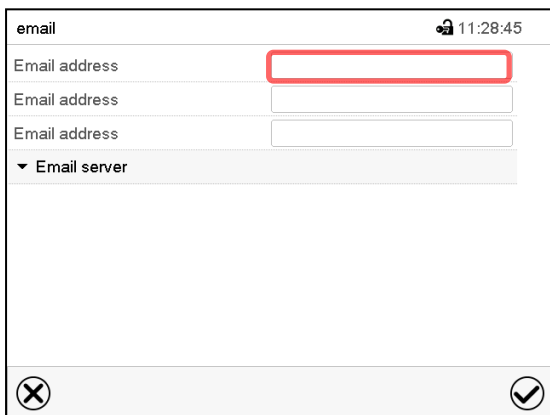

email		🔒 11:28:45
Email address	<input type="text"/>	
Email address	<input type="text"/>	
Email address	<input type="text"/>	
▼ Email server		

“Email” submenu.

Select the desired e-mail address field and enter the e-mail address. You can use the **Keyboard change** icon for entry. Confirm entry with **Confirm** icon.

#### E-mail server settings:

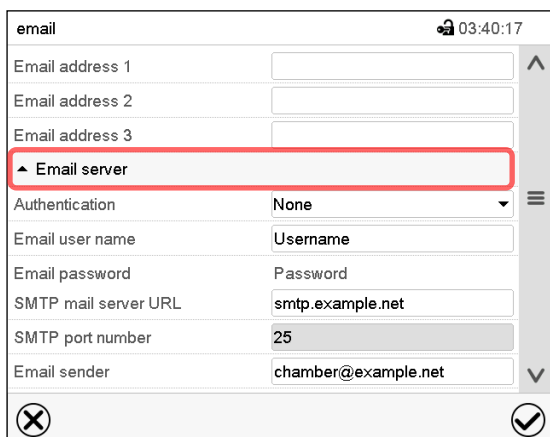

email		🔒 03:40:17
Email address 1	<input type="text"/>	^
Email address 2	<input type="text"/>	
Email address 3	<input type="text"/>	
▲ Email server		☰
Authentication	None	∇
Email user name	Username	
Email password	Password	
SMTP mail server URL	smtp.example.net	
SMTP port number	25	
Email sender	chamber@example.net	∇

“Email” submenu.

Select the field “Email server” to access the settings

- In the field “Authentication” select the desired setting “None” or “SMTP” auth“.

With the setting “SMTP auth”, you can enter a password under “Email password”.

Authentication	None
Email user name	None
Email password	SMTP auth
SMTP mail server URL	192.168.10.45

- Select the field “Email user name” and enter the desired user name. Confirm entry with **Confirm** icon.
- Select the field “SMTP mail server URL” and enter the SMPT mail server URL. Confirm entry with **Confirm** icon.
- Select the field “SMTP port number” and enter the desired port number. Standard setting: “25”. Confirm entry with **Confirm** icon.
- Select the field “Email sender” and enter the desired Email sender. Confirm entry with **Confirm** icon.

After completing the settings, press the **Confirm** icon to take over the entries and exit the menu, **or** press the **Close** icon to exit the menu without taking over the entries.

## 15.6 USB menu: Data transfer via USB interface

The USB port is located in the instrument box.

When you insert a USB-stick, the “USB” menu opens.



The USB stick must be formatted with FAT32 and have at least 8GB of memory.

Depending on the user’s authorization level, different functions (highlighted in black) are available for the logged-in user.

USB menu	
Log-out USB stick	^
Export new chart recorder data (*.DAT)	
Export all chart recorder data (*.DAT)	
Export all chart recorder data (*.csv)	≡
Import configuration and programs	
Export configuration and programs	
Import programs	v
Export service data	
Software update	
	✔

Available functions  
with “User” authorization level

USB menu	
Log-out USB stick	^
Export new chart recorder data (*.DAT)	
Export all chart recorder data (*.DAT)	
Export all chart recorder data (*.csv)	≡
Import configuration and programs	
Export configuration and programs	≡
Import programs	
Export service data	
Software update	
	✔

Available functions  
with “Admin” authorization level

Function	Explanation
Log-out USB stick	Log-out USB stick bevor pulling it
Export new chart recorder data (*.DAT)	Export chart recorder data, which have been added since last export, in .dat format
Export all chart recorder data (*.DAT)	Export all chart recorder data in .dat format
Export all chart recorder data (*.csv)	Export all chart recorder data in .csv format

Function	Explanation
Import configuration and programs	Import configuration and timer / time / week programs
Export configuration and programs	Export configuration and timer / time / week programs
Import programs	Import timer / time / week programs
Export service data	Export service data
Software update	Controller firmware update

## 16. General information

### 16.1 Service contact page

Path: [Main menu > Contact](#)

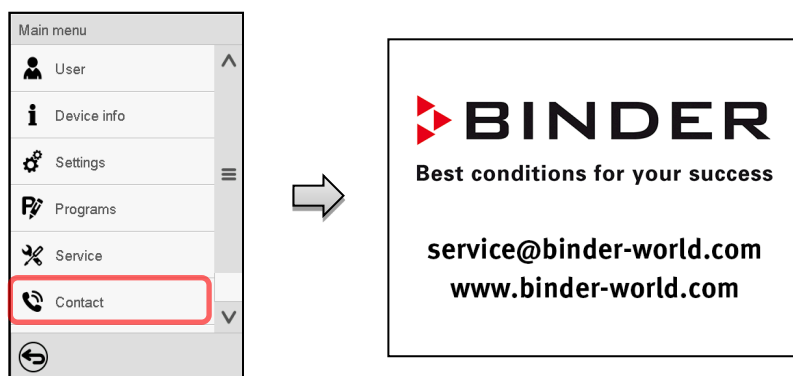

### 16.2 Current operating parameters

 Press the **Information** icon to access the “Info” menu from Normal display.

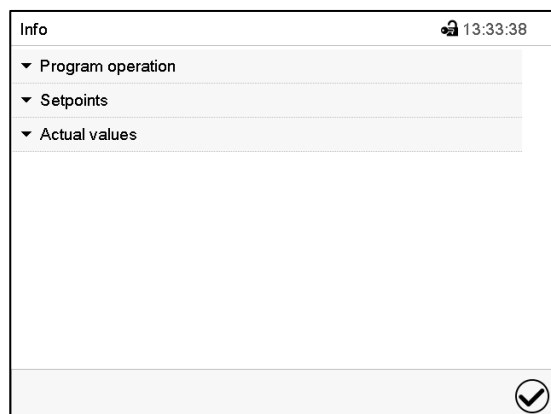

“Info” menu.  
Select the desired information.

- Select “Program operation” to see information on a currently running program
- Select “Setpoints” to see information on the entered setpoints, and special controller functions.
- Select “Actual values” to see information on the current actual values.

### 16.3 Event list

The “Event list” displays status information and errors of the current day. It enables to view the last 100 events or defective conditions of the chamber.

 Press the **Event list** icon to access the event list from Normal display.

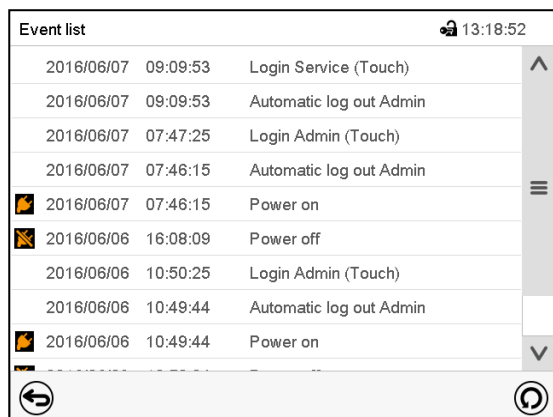







Event list

 Press the **Update** icon to update the event list.

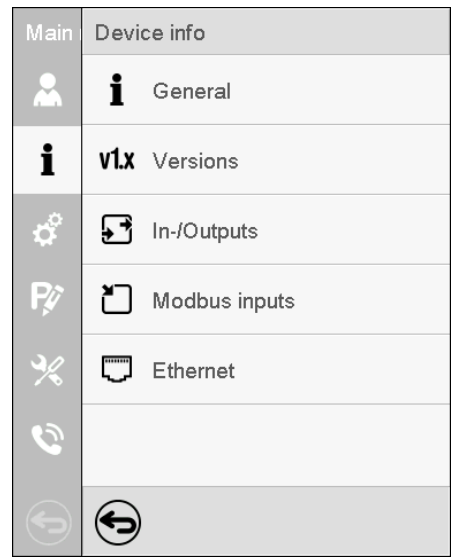
 **Attention:** Following a modification of the language setting (chap. 15.1) or the storage interval of the chart recorder (chap. 17.2) the Event list is cleared.

### 16.4 Technical chamber information

Path: [Main menu > Device info](#)

	Device info		
	 General	Chamber name and setup	
	 v1.x Versions	Versions of CPU, I/O module and safety controller	for BINDER Service
	 In-/Outputs	Information on digital and analog inputs and outputs and phase angle outputs	for BINDER Service
	 Modbus inputs	Information on modbus analog and digital inputs	for BINDER Service
	 Ethernet	Information on Ethernet connection, MAC address display	chap. 15.5.1
	 Back to main menu		

## 17. Chart recorder display

This view offers graphic representation of the measurement course. Data representation imitates a chart recorder and allows recalling any set of measured data at any point of time taken from the recorded period.

### 17.1 Views

	Press the <b>Change view</b> icon to access the pen recorder display.
--	---

#### 17.1.1 Show and hide legend

	<b>Show legend</b>		<b>Hide legend</b>
--	--------------------	--	--------------------

Press the **Show legend** icon to display the legend on the right side of the display

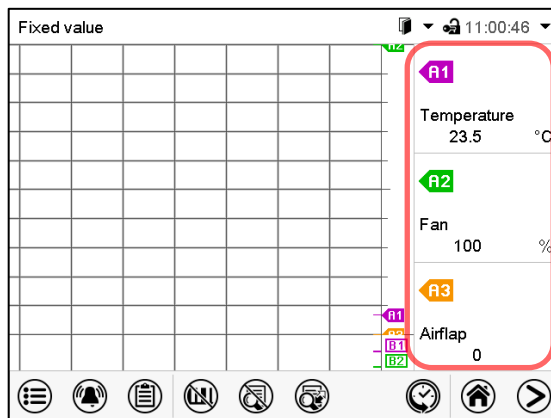

Legend shown on the right side of the display

#### 17.1.2 Switch between legend pages

	<b>Switch legend</b>
--	----------------------

Press the **Switch legend** icon to switch between the legend pages

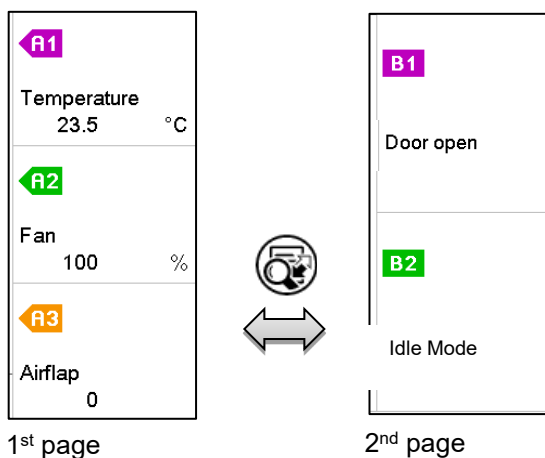

Switching between the legend pages

### 17.1.3 Show and hide specific indications

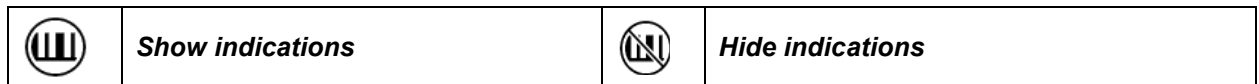

Press the **Show indications** icon to display the indications Temperature (A1), Fan (A2), Air flap (A3) or “Door open” (B1), and “Idle mode” (B2).

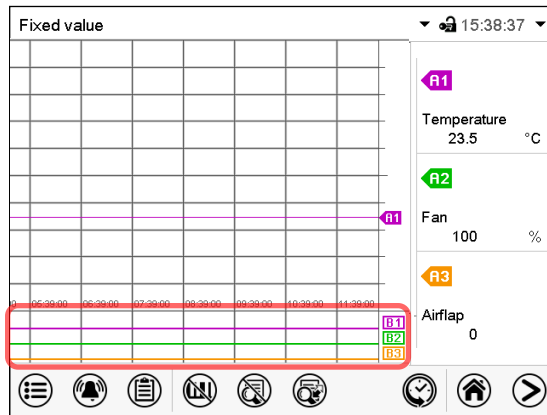

Indications “Door open” (B1), and “Idle mode” (B2) are displayed.

### 17.1.4 History display



Press the **History display** icon to change to the history display.

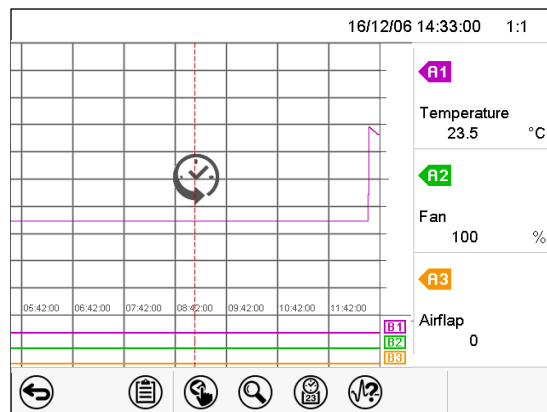

History display.

The chart recorder is paused. Data recording continues in the background.

Move the central red line by tapping and holding to the desired position.

The legend at the right side shows the values of the current line position.

Then further icons appear:

### History display: Curve selection

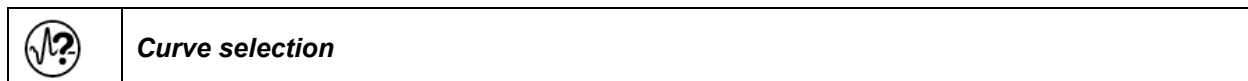

Press the **Curve selection** icon to access the “Curve selection” submenu.

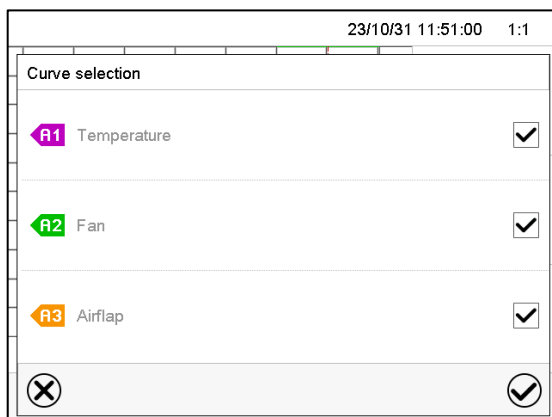

“Curve selection” submenu.

Select the curves to be displayed by checking the checkbox of the corresponding parameter. Press the **Confirm** icon

### History display: Search the required instant

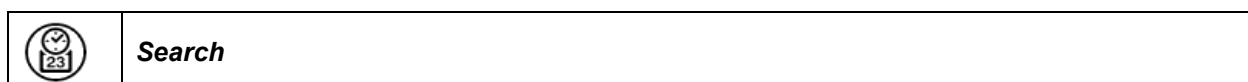

Press the **Search** icon to access the “Search” submenu.

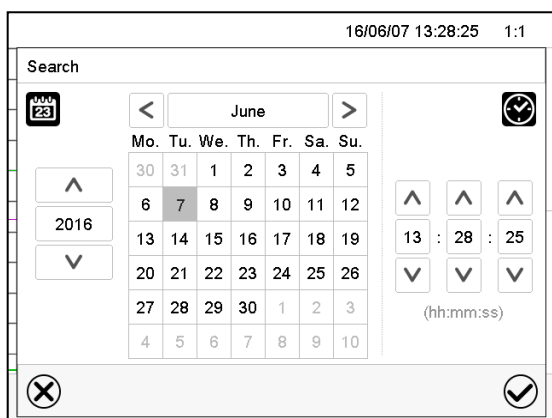

“Search” submenu.

Select the required instant by entering its date and time and press the **Confirm** icon



### History display: Zoom function



Press the **Zoom** icon to access the “Zoom” submenu.

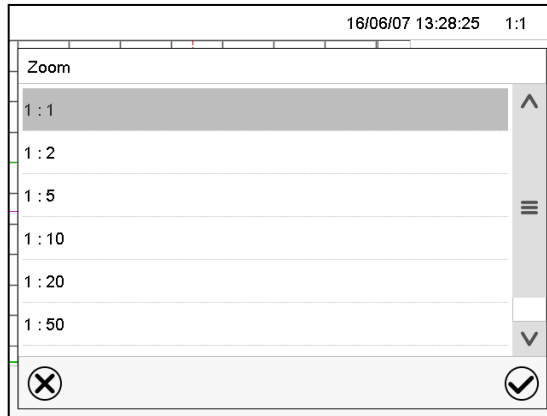

“Zoom” submenu.

Select the zoom factor and press the **Confirm** icon

### History display: Show and hide scroll buttons to scroll to an instant



Press the **Show scroll buttons** icon to access the “Page selection” submenu.

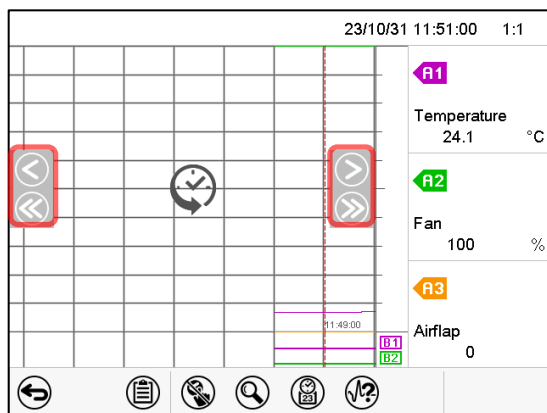

“Page selection” submenu.

Scroll buttons are shown on the left and on the right. Use them to move along the timeline.

## 17.2 Setting the parameters

This menu allows setting the storage interval, the type of values to be shown and the scaling of the temperature charts.

Path: [Main menu](#) > [Settings](#) > [Measurement chart](#)

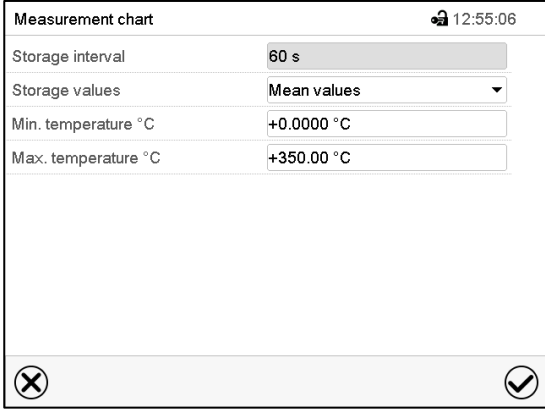

“Measurement chart” submenu.

- Select the field “Storage interval” and enter the desired storage interval. Confirm entry with **Confirm** icon.

The available presentation depends on the pre-selected storage rate. Factory setting: 60 seconds. This means the higher the storage rate, the more precisely but shorter the data representation will be.

- In the field “Storage values” select the desired value type to be displayed.

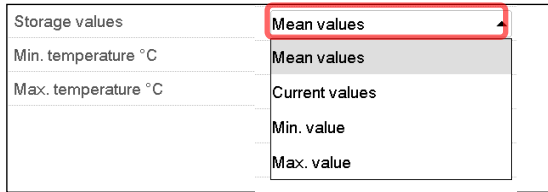

- For scaling the representation select the desired minimum and maximum temperature value and enter the desired values. Temperature display range: 0 °C up to 300 °C. Confirm entry with **Confirm** icon.

Setting the storage rate or rescaling (minimum and/or maximum) will clear the measured-value memory and the event list.

	<b>NOTICE</b>
	<p><b>Danger of information loss when setting the storage rate or rescaling.</b>  <b>Data loss of measured-value memory and event list.</b></p> <p>➤ Change the storage rate or scaling <b>ONLY</b> if the previously registered data is no longer needed.</p>

After completing the settings, press the **Confirm** icon to take over the entries and exit the menu, **or** press the **Close** icon to exit the menu without taking over the entries.

## 18. Options

### 18.1 APT-COM™ 4 Multi Management Software (option)

The chamber is regularly equipped with an Ethernet interface (4) that can connect the APT-COM™ 4 Multi Management Software. The MAC Address is indicated in the “Device info” controller menu (chap. 15.5.1.2). The actual temperature values are given at adjustable intervals. Programming can be performed graphically via PC. Up to 100 chambers can be cross-linked. For further information on networking please refer to the APT-COM™ 4 operating manual.

There are three variants available:

- APT-COM™ 4 BASIC-Edition – for simple recording and documentation requirements with up to 5 networked chambers.
- APT-COM™ 4 PROFESSIONAL-Edition – including scope of BASIC-Edition, additionally with convenient chamber and user management, suitable for networking up to 100 chambers.
- APT-COM™ 4 GLP-Edition – including scope of PROFESSIONAL-Edition, additionally suitable for working under GLP-compliant conditions. The measured values are documented in a tamper-proof manner in accordance with the requirements of the FDA guideline 21CFR11.

### 18.2 Object temperature display with flexible Pt100 temperature sensor (option)

The object temperature display enables the determination of the actual temperature of the charging material during the whole process. The object temperature is measured via a flexible Pt100 temperature sensor and can be viewed on the controller display. You can immerse the sensor top protective tube of the flexible Pt 100 into liquid substances.

Fixed value		Setpoint	Actual value
Temperature	°C	<b>25.0</b>	<b>25.0</b>
Obj. Temp.	°C		<b>10.6</b>

Normal display with object temperature display  
(sample values)

The object temperature data are put out together with the data of the temperature controller and can be documented by the APT-COM™ 4 Multi Management Software (option, chap. 18.1) developed by BINDER.

#### Technical data of the Pt100 sensor:

- Three-wire technique
- Class B (DIN EN 60751)
- Temperature range up to 320 °C / 608°F
- Stainless steel protective tube with a length of 45 mm / 1.78 in, material no. 1.4501

### 18.3 Object temperature control with flexible Pt100 temperature sensor (option)

This function serves to ensure that the load will not become too hot due to the surrounding interior temperature while the target temperature inside the load has not yet been reached.

For this purpose, the temperature setpoint is regulated in a way that it is achieved inside the load. The flexible Pt100 temperature sensor is used for this purpose, which measures the object temperature, displays it on the controller display and regulates it accordingly. You can immerse the sensor top protective tube of the flexible Pt 100 into liquid substances.

Fixed value		Setpoint	Actual value
Temperature	°C	150	30.0
Fan	%	100	
Air flap		0	
Obj.-Temp.	°C	150	10,2
Trim		2	

Normal display with object temperature control option (sample values)

The trim value is added to the object temperature setpoint and limits the actual value in the interior to the resulting sum. This makes it effective as an overheating protection for the load.



As soon as the object temperature control has been activated (trim value > 0), the standard set-point is non-functional.

Example:

Object temperature setpoint: 150 °C, trim value: 2 K. Resulting actual value: max. 152 °C

Without trimming (setting to 0) the desired object temperature setpoint will never be reached, as for this, the temperature in the inner chamber, i.e. in the ambience of the test sample, must be slightly higher than the target value.

#### Entry of the object temperature setpoint and the trim value:

You can enter the set-points Sollwerteingabe either via the “Setpoint” setting menu (chap. 8.1) or directly via Normal display (chap. 8.3)

- Select the field “Obj.-Temp” and enter the desired object temperature setpoint.  
Setting range: 0 °C up to 300 °C. Confirm entry with **Confirm** icon.
- Select the field “Trim” and enter the desired trim value.  
Setting range: 0 K bis up to 10 K. „0“ = off. Confirm entry with **Confirm** icon.

Setpoints		13:08:28
▲ Fixed-value operation setpoints		
Temperature	+150.00 °C	
Fan	+100.00 %	
Air flap	+0.0000	
Obj.-Temp	+0.0000 °C	
Trim	+0.0000 °C	
Functions on/off	0000000000000000	
▼ Control on/off		
▼ Safety controller		

“Setpoints” menu with object temperature control option.

Select “Fixed value operation setpoints” to access the individual parameters.

The object temperature data are put out together with the data of the temperature controller and can be documented by the APT-COM™ 4 Multi Management Software (option, chap. 18.1) developed by BINDER.

**Technical data of the Pt100 sensor:**

- Three-wire technique
- Class B (DIN EN 60751)
- Temperature range up to 320 °C / 608°F
- Stainless steel protective tube with a length of 45 mm / 1.78 in, material no. 1.4501

**18.4 Analog output for temperature (option)**

With this option the chamber is equipped with an analog output 4-20 mA for temperature. This output permits transmitting data to external data registration systems or devices.

The connection is realized as a 9-poles SUB-D socket “Analog output” (7) as follows:

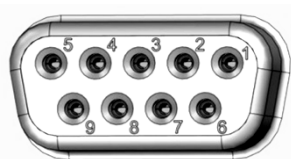

Analog output 4-20 mA DC  
 PIN 6: Temperature –  
 PIN 7: Temperature +  
**Temperature range:** 0 °C up to +300 °C

Figure 14: Pin configuration of the SUB-D socket “Analog output” (7) for the analog outputs option

**18.5 HEPA fresh air filter (option)**

With this option, the introduced fresh air is cleaned by means of a high efficiency submicron particulate air filter type HEPA class H 14 (acc. to DIN EN 1822:2009), 99,995 % with 0,3 µm. Replace the filter insert, if necessary, by removing the metal cover of the filter at the left side of the chamber (Art. No. 6014-0003).

**18.6 Mostly gas-tight version (option)**

With this option the chamber is additionally sealed, so the loss when introducing gases is decreased. The chamber is not completely gas-tight, so it is impossible to establish overpressure. The sealing diminishes the release of vapors via the housing that may be set free from the charging material when heated. Carrying-off via the regular evacuation duct, e.g. into a waste air installation, is likely to further reduce emissions.

	<p>The chamber is not completely gas-tight. Gases from inside the chamber can escape into the surrounding atmosphere.</p> <p>Observe the occupational exposure limit OEL for the released substance set by the national authorities (formerly maximum permitted workplace concentration). Respect the relevant regulations.</p> <p>Any harmful gas that might escape has to be led out via good room ventilation or a suitable exhaust system. Place the chamber, if necessary, below a gas vent.</p>
---	---

The air flap does not close the exhaust duct completely. The delivered plug serves to avoid emerging of vapors or loss of introduced inert gas, if any, via the exhaust duct. Due to special demands of heat resistance, use the delivered plug only.

	<p><b>NOTICE</b></p>
	<p><b>Danger of inflammation when using an inappropriate plug.</b>  <b>Damage to the chamber and ist surroundings.</b></p> <p>➤ Use ONLY the supplied plug to close the exhaust duct.</p>

For drying purpose, please remove the plug in order to permit dissipation of the generated vapor, which would lead to condensation in the inner chamber.

## 18.7 Inert gas connection with mostly gas-tight version (option)

With this option the chamber is additionally sealed, so the loss when introducing inert gases is decreased. For details on the mostly gas-tight version please refer to chap. 18.6.

The chamber is equipped with two ports for inert gas (nitrogen or noble gases).

The ports are located **on the top panel in the middle (A)** and **on the chamber rear at the bottom left (seen from the back) (B)**. Each of these ports can be used as inlet or outlet, depending on the nature of the inert gas:

- lighter gas (nitrogen, helium): lower port as inlet
- heavy gas (e.g. argon): upper port as inlet

This distinction is important when operating with a reduced fan speed.

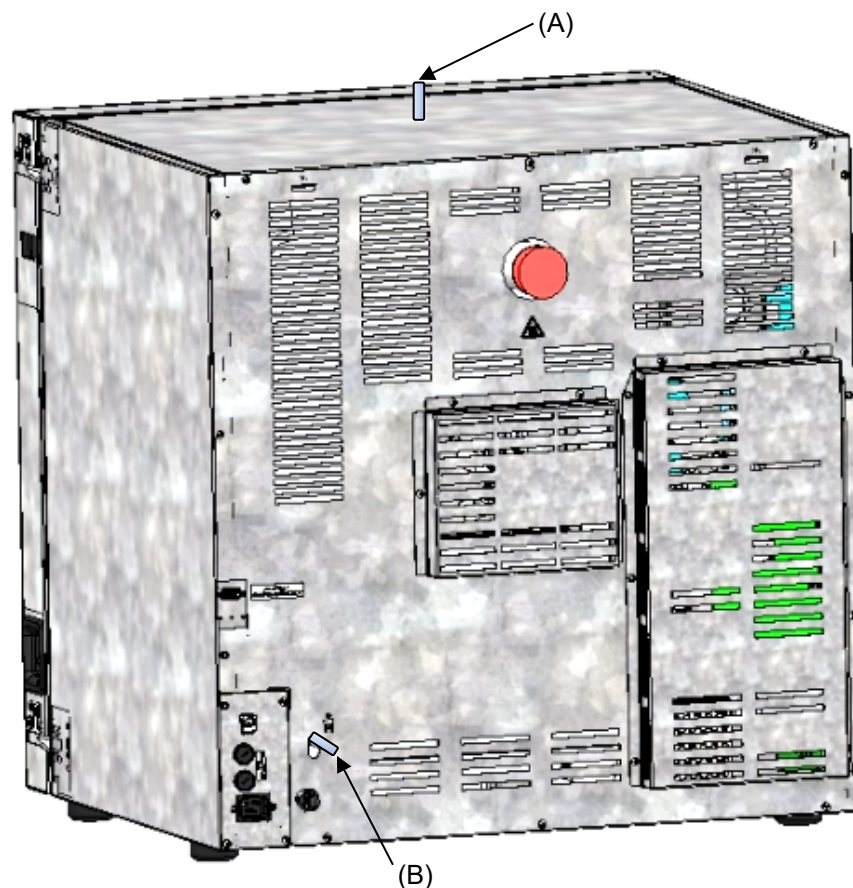



Figure 15: Position of the inert gas ports on the top panel (A) and on the chamber rear (B)

## Connection

Observe the legal requirements and relevant standards and regulations for the safe handling of gas cylinders and inert gases.

	<p>General information for safe handling of gas cylinders:</p> <ul style="list-style-type: none"> <li>• Store and use gas cylinders only in well ventilated areas.</li> <li>• Open the gas cylinder valve slowly to avoid pressure surges</li> <li>• Secure gas cylinders during storage and use against falling (chaining).</li> <li>• Transport gas cylinders with a cylinder cart, do not carry, roll, or throw them</li> <li>• Always close the valve even with apparently empty cylinders; screw on the cap when not in use. Return gas cylinders with the valve closed</li> <li>• Do not open gas cylinders by force. Mark them when damaged</li> <li>• Observe relevant regulations for dealing with gas cylinders.</li> </ul>
---	---



Connect a flexible gas tube to the gas hose connection adapter (A) or (B) (outer diameter 10mm), which is used for gas inlet, and secure it with hose clamps (hose and hose clamps are not enclosed). There is a constant gas flow after establishing the connection.

	<p>After connecting the gas cylinder, check all gas connections for leaks (e.g. with leak spray or diluted soap solution).</p>
---	--

Use a pressure reducer and make sure to avoid any excessive outlet pressure when connecting the gas hose to the chamber.

	<p>The chamber is not entirely gas-tight. Inert gases from inside the chamber can escape into the surrounding atmosphere.</p>
---	---

Inert gases in high concentrations is hazardous to health. They are colorless and almost odorless and therefore practically imperceptible. Inhalation of inert gases can cause drowsiness up to respiratory arrest. When the O<sub>2</sub> content of the air decreases below 18%, there is risk of death from lack of oxygen. Any gas that might escape has to be led out via good room ventilation or a suitable exhaust system.

	 <b>DANGER</b>
	<p><b>Risk of suffocation through high concentration of inert gas.</b>  <b>Death by suffocation.</b></p> <ul style="list-style-type: none"> <li>⊘ Do NOT set up chambers in non-ventilated recesses.</li> <li>➤ Ensure technical ventilation measures.</li> <li>➤ Observe the relevant regulations for handling inert gases.</li> <li>➤ Close the gas supply when decommissioning the chamber.</li> </ul>

	<p>Inert gases, which are heavier than air, may accumulate in low-lying areas of the installation site.</p>
---	---

The “Mostly gas-tight version” reduces the loss of gas.

### Setting (sample values):

If you want to flush the chamber with an air exchange rate of 1 per hour, set the flow rate on the pressure reducer according to the interior volume.

Chamber with 56 l internal volume: The flow rate corresponding to 56 l / h is 0.9 l / min.

Chamber with 115 l internal volume: The flow rate corresponding to 115 l / h is 1.9 l / min.

Chamber with 260 l internal volume: The flow rate corresponding to 260 l / h is 4.3 l / min.

The air flap does not close the exhaust duct completely. The delivered plug serves to avoid loss of introduced inert gas via the exhaust duct. Due to special demands of heat resistance, use the delivered plug only.





	NOTICE
	<p><b>Danger of inflammation when using an inappropriate plug.</b>  <b>Damage to the chamber and its surroundings.</b></p> <ul style="list-style-type: none"> <li>➤ Use ONLY the supplied plug to close the exhaust duct.</li> </ul>

For drying purpose, please remove the plug in order to permit dissipation of the generated vapor, which would lead to condensation in the inner chamber.

## 19. Cleaning and decontamination

Clean the chamber after each use in order to prevent potential corrosion damage by ingredients of the loading material.

Prior to renewed startup, allow the chamber to completely dry after all cleaning and decontamination measures.

  	 <b>DANGER</b>
	<p><b>Electrical hazard by water entering the chamber.</b>  <b>Deadly electric shock.</b></p> <ul style="list-style-type: none"> <li>⊘ Do NOT spill water or cleaning agents over the inner and outer chamber surfaces.</li> <li>⊘ Do NOT put ANY cleaning aids (cloth or brush) into slots or openings on the chamber.</li> <li>➤ Before cleaning, turn off the chamber with the on/off switch (4) or main power switch (11) and disconnect the power plug. Let the chamber cool down to ambient temperature.</li> <li>➤ Completely dry the chamber before turning it on again.</li> </ul>

### 19.1 Cleaning

Disconnect the chamber from the power supply before cleaning. Disconnect the power plug.

	<p>The interior of the chamber must be kept clean. Thoroughly remove any residues of the charging material</p>
---	--

Wipe the surfaces with a moistened towel. In addition, you can use the following cleaning agents:

Exterior surfaces inner chamber racks door gaskets	Standard commercial cleaning detergents free from acid or halides. Alcohol-based solutions. We recommend using the neutral cleaning agent Art. No. 1002-0016.
Instrument panel	Standard commercial cleaning detergents free from acid or halides. We recommend using the neutral cleaning agent Art. No. 1002-0016.
Zinc coated hinge parts rear chamber wall	Standard commercial cleaning detergents free from acid or halides. Do NOT use a neutral cleaning agent on zinc coated surfaces.

Do not use cleaning agents that may cause a hazard due to reaction with components of the device or the charging material. If there is doubt regarding the suitability of cleaning products, please contact BINDER service.



	<p>We recommend using the neutral cleaning agent Art. No. 1002-0016 for a thorough cleaning. Any corrosive damage that may arise following use of other cleaning agents is excluded from liability by BINDER GmbH.</p> <p>Any corrosive damage caused by a lack of cleaning, is excluded from liability by BINDER GmbH.</p>
---	---

	<p style="text-align: center;"><b>NOTICE</b></p> <p><b>Danger of corrosion by using unsuitable cleaners.</b>  <b>Damage to the chamber.</b></p> <ul style="list-style-type: none"> <li>∅ Do NOT use acidic or chlorine cleaning detergents.</li> <li>∅ Do NOT use a neutral cleaning agent on other kind of surfaces e.g., the zinc coated hinge parts or the rear chamber wall.</li> </ul>
---	---

	<p>For surface protection, perform cleaning as quickly as possible. After cleaning completely remove cleaning agents from the surfaces with a moistened towel. Let the chamber dry.</p>
---	---



	<p>Soapsuds may contain chlorides and must therefore NOT be used for cleaning.</p>
---	--

	<p>With every decontamination method, always use adequate personal safety controls.</p>
--	---

Following cleaning, leave the chamber door open or remove the plugs of the optional access port.

	<p>The neutral cleaning agent may cause health problems in contact with skin and if ingested. Follow the operating instructions and safety hints labeled on the bottle of the neutral cleaning agent.</p>
---	---

Recommended precautions: To protect the eyes use sealed protective goggles. Wear gloves. Suitable protective gloves in full contact with media: butyl or nitrile rubber, penetration time >480 minutes.

	<p style="text-align: center;"> <b>CAUTION</b></p> <p><b>Danger of chemical burns through contact with skin or ingestion of the neutral cleaning agent.</b>  <b>Skin and eye damage. Environmental damage.</b></p> <ul style="list-style-type: none"> <li>∅ Do not ingest the neutral cleaning agent. Keep it away from food and beverages.</li> <li>∅ Do NOT empty the neutral cleaning agent into drains.</li> <li>➤ Wear protective gloves and goggles.</li> <li>➤ Avoid skin contact with the neutral cleaning agent.</li> </ul>
---	---

## 19.2 Decontamination / chemical disinfection

The operator must ensure that proper decontamination is performed in case a contamination of the chamber by hazardous substances has occurred.

Disconnect the chamber from the power supply prior to decontamination. Pull the power plug.

Do not use decontamination agents that may cause a hazard due to reaction with components of the device or the charging material. If there is doubt regarding the suitability of cleaning products, please contact BINDER service.

You can use the following disinfectants:

Inner chamber	Standard commercial surface disinfectants free from acid or halides. Alcohol-based solutions. We recommend using the disinfectant spray Art. No. 1002-0022.
---------------	---

	For chemical disinfection, we recommend using the disinfectant spray Art. No. 1002-0022. Any corrosive damage that may arise following use of other disinfectants is excluded from liability by BINDER GmbH.
---	--

	With every decontamination / disinfection method, always use adequate personal safety controls.
---	---



In case of impurity of the interior with biological or chemical hazardous material, there are three possible procedures depending on the type of contamination and of the charging material.

1. The drying and heating ovens M can be hot air sterilized at e.g., 190 °C / 374 °F for at least 30 minutes. All inflammable goods must be removed from the interior before.
2. Spray the inner chamber with an appropriate disinfectant.

Before start-up, the chamber must be absolute dry and ventilated, because explosive gases may form during the decontamination process.

	In case of eye contact, the disinfectant spray may cause eye damage due to chemical burns. Follow the operating instructions and safety hints labeled on the bottle of the disinfectant spray.
---	--

Recommended precautions: To protect the eyes use sealed protective goggles.

	 <b>CAUTION</b>
	<p><b>Danger of chemical burns through eye contact with the disinfectant spray.</b></p> <p><b>Eye damage. Environmental damage</b></p> <ul style="list-style-type: none"> <li>⊘ Do NOT empty the disinfectant into drains.</li> <li>➤ Wear protective goggles.</li> </ul>

	After using the disinfectant spray, allow the chamber to dry thoroughly, and aerate it sufficiently.
---	--

## 20. Maintenance and service, troubleshooting, repair, testing

### 20.1 General information, personnel qualification

- **Maintenance**

See chap. 20.2.

- **Simple troubleshooting**

Chap. 20.3 describes troubleshooting by operating personnel. It does not require technical intervention into the chamber, nor disassembly of chamber parts.

For personnel requirements please refer to chap. 1.1.

- **Detailed troubleshooting**

If errors cannot be identified with simple troubleshooting, further troubleshooting must be performed by BINDER Service or by BINDER qualified service partners or technicians, in accordance with the description in the Service Manual.

For personnel requirements please refer to the Service Manual.

- **Repair**

Repair of the chamber can be performed by BINDER Service or by BINDER qualified service partners or technicians, in accordance with the description in the Service Manual.



After maintenance, the chamber must be tested prior to resuming operation.

- **Electrical testing**

To prevent the risk of electrical shock from the electrical equipment of the chamber, an annual repeat inspection as well as a test prior to initial startup and prior to resuming operation after maintenance or repair, are required. This test must meet the requirements of the competent public authorities. We recommend testing under EN 50678/VDE 0701 and EN 50699/VDE 0702 in accordance with the details in the Service Manual.

For personnel requirements please refer to the Service Manual.

### 20.2 Maintenance intervals, service

 	<div style="background-color: red; color: white; text-align: center; padding: 5px;">  <b>DANGER</b> </div> <p><b>Electrical hazard during live maintenance work.</b>  <b>Deadly electric shock.</b></p> <ul style="list-style-type: none"> <li>Ø The chamber must NOT become wet during operation or maintenance works.</li> <li>Ø Do NOT remove the rear panel of the chamber.</li> <li>➤ Disconnect the chamber before conducting maintenance work. Turn off the chamber with the on/off switch (4) or main power switch (11) and pull the power plug.</li> <li>➤ Make sure that all maintenance work will be conducted by licensed electricians or experts authorized by BINDER.</li> </ul>
--	---

Ensure regular maintenance work is performed at least once a year.

	<p>The warranty becomes void if maintenance work is conducted by non-authorized personnel.</p>
---	--

	<p>Replace the door gasket only when cold. Otherwise, the door gasket may become damaged.</p>
---	---

We recommend taking out a maintenance agreement. Please consult BINDER Service.

BINDER telephone hotline: +49 (0) 7462 2005 555  
 BINDER fax hotline: +49 (0) 7462 2005 93555  
 BINDER service hotline USA: +1 866 885 9794 or +1 631 224 4340 x3 (toll-free in the USA)  
 BINDER service hotline Asia Pacific: +852 390 705 04 or +852 390 705 03  
 BINDER Internet website: <http://www.binder-world.com>  
 BINDER address: BINDER GmbH, post office box 102, D-78502 Tuttlingen

International customers, please contact your local BINDER distributor.

## 20.3 Simple troubleshooting

Defects and shortcomings can compromise the operational safety of the chamber and can lead to risks and damage to equipment and persons. If there is a technical fault or shortcoming, take the chamber out of operation and inform BINDER Service. If you are not sure whether there is a technical fault, proceed according to the following list. If you cannot clearly identify an error or there is a technical fault, please contact BINDER Service.



Only qualified service personnel authorized by BINDER must perform repair. Repaired chambers must comply with the BINDER quality standards.

Fault description	Possible cause	Required measures
<b>General</b>		
Chamber without function.	No power supply.	Check connection to power supply. Check whether the chamber is turned on with the On/Off switch (4) or main power switch (11).
	Wrong voltage.	Check power supply for correct voltage (chap. 4.1).
	Chamber fuse has responded.	Check chamber fuse and replace it if appropriate (chap. 22.3). If it responds again, contact BINDER service.
	Defective controller.	Contact BINDER service.
	Overtemperature protective device class 1 has turned off the chamber.	Disconnect the chamber from the power supply for at least 10 seconds and let it cool down. If the device responds again, contact BINDER service.
<b>Temperature</b>		
Set-point temperature is not reached after specified time.	Chamber door not properly closed.	Completely close chamber door.
	Defective door gasket.	Replace door gasket,
	Controller not adjusted.	Calibrate and adjust controller.
	Wrong voltage.	Check the power supply for correct voltage (chap. 4.1).
Chamber heating permanently, set-point not held.	Defective controller.	Contact BINDER service.
	Defective Pt 100 sensor.	
	Defective semiconductor relay.	Calibrate and adjust controller.
	Controller not adjusted.	
Chamber doesn't heat up. Heating icon is displayed.	Defective heating element.	Contact BINDER service.
	Defective semiconductor relay.	

Fault description	Possible cause	Required measures
<b>Temperature (continued)</b>		
Chamber doesn't heat up. No heating icon in the display. Controller display working.	Timer run off.	Re-program the timer or turn it off.
	Defective semiconductor relay.	Contact BINDER service.
	Defective controller.	
Chamber doesn't heat up. Alarm message "Overtemperature" is displayed.	Overtemperature protective device class 1 (thermal switch) activated.	Proceed as described in chap. 13.1. If appropriate, contact BINDER service.
Chamber doesn't heat up. Alarm message "Safety contr. class 3.1" is displayed.	Safety controller class 3.1 has responded.	Check the settings of the temperature set-point and of the safety device class 3.1 (chap. 13.2).
	Safety controller defective.	Contact BINDER service.
Chamber doesn't heat up. Alarm message "Safety contr. class 2" is displayed.	Safety device class 2 has turned off the chamber.	Let cool down the chamber. Check the settings of the temperature set-point and of the safety device class 2 (chap. 13.2). If appropriate, select suitable limit value.
	Safety controller defective.	Contact BINDER service.
Deviations from the indicated heating-up times.	Chamber fully loaded.	Load the chamber less or consider longer heating-up times.
<b>Controller</b>		
No chamber function (dark display).	Display in standby mode.	Press on touchscreen.
	Main power switch turned off.	Turn on the main power switch.
Menu functions not available.	Menu functions not available with current authorization level.	Log in with the required higher authorization or contact BINDER service to obtain an activation code (chap. 14.6).
No access to controller	Password incorrect.	Contact BINDER service.
Chart recorder function: measured-value memory cleared; information lost.	New setting of storage rate or scaling (minimum and/or maximum) (chap. 17.2).	Change the storage rate or scaling ONLY if the previously registered data are no longer required.
Controller does not equilibrate to setpoints entered in Fixed value operation mode	Controller is not in Fixed value operation mode.	Change to Fixed value operation mode.
Controller does not equilibrate to program set-points.	Controller is not in program operation mode, or program delay time is running.	Start the program again. If appropriate, wait for the program delay time.
Program duration longer than programmed.	Tolerances have been programmed.	For rapid transition phases, do NOT program tolerance limits in order to permit maximum heating or refrigerating speed.
Program keeps the last program setpoint constant while in setting "ramp".	Program line with setting "ramp" is incomplete.	When programming with setting "ramp", define the end value of the desired cycle by adding an additional section with a section time of at least one second.
Ramp temperature transitions are only realized as steps.	Setting "step" has been selected.	Select setting "ramp".
Acknowledging the alarm does not cancel the alarm state.	Cause of alarm persists.	Remove cause of alarm. If the alarm state continues, contact BINDER service.
Alarm message: - - - - or <-<-< or >>->>	Sensor rupture between sensor and controller or Pt 100 sensor defective.	Contact BINDER service.
	Short-circuit.	

Fault description	Possible cause	Required measures
<b>Miscellaneous</b>		
The fan doesn't turn or turns too slowly.	Fan speed set too low	Set fan speed to 100%
	Defective fan.	Contact BINDER service.

## 20.4 Sending the chamber back to BINDER GmbH

If you return a BINDER product to us for repair or any other reason, we will only accept the product upon presentation of an **authorization number** (RMA number) that has previously been issued to you. An authorization number will be issued after receiving your complaint either in writing or by telephone **prior** to your sending the BINDER product back to us. The authorization number will be issued following receipt of the information below:

- BINDER product type and serial number
- Date of purchase
- Name and address of the dealer from which you bought the BINDER product
- Exact description of the defect or fault
- Complete address, contact person and availability of that person
- Exact location of the BINDER product in your facility
- A contamination clearance certificate (chap. 24) must be faxed in advance

The authorization number must be applied to the packaging in such a way that it can be easily recognized or be recorded clearly in the delivery documents.



For safety reasons we cannot accept a chamber delivery if it does not carry an authorization number.

**Return address:** BINDER GmbH, Abteilung Service  
Gänsäcker 16, 78502 Tuttlingen, Germany

## 21. Disposal

### 21.1 Disposal of the transport packing

Packing element	Material	Disposal
Straps to fix packing on pallet	Plastic	Plastic recycling
Wooden transport box (option) with metal screws	Non-wood (compressed match-wood, IPPC standard)	Wood recycling
	Metal	Metal recycling
Pallet (from size 115 on)	Solid wood (IPPC standard)	Wood recycling
Transport box with metal clamps	Cardboard	Paper recycling
	Metal	Metal recycling
Top cover (size 720)	Cardboard	Paper recycling
Edge protection	Styropor® or PE foam	Plastic recycling
Protection of doors and racks	PE foam	Plastic recycling
Bag for operating manual	PE foil	Plastic recycling
Insulating air cushion foil (packing of optional accessories)	PE foil	Plastic recycling

If recycling is not possible, all packing parts can also be disposed of with normal waste.

### 21.2 Decommissioning

- Turn off the chambers at the On(Off switch (4) or main power switch (11).
- Disconnect the chamber from the power supply (pull the power plug).
- With option inert gas connection (chap. 18.7): Close the inert gas supply and remove the gas connection.

	 <b>DANGER</b>
	<p><b>Risk of suffocation through high concentration of inert gas.</b>  <b>Death by suffocation.</b></p> <ul style="list-style-type: none"> <li>➤ Observe the relevant regulations for handling inert gases.</li> <li>➤ Close the gas supply when decommissioning the chamber.</li> </ul>

- Temporal decommissioning: See indications for appropriate storage, chap. 3.3.
- Final decommissioning: Dispose of the chamber as described in chap. 21.3 to 21.5.

### 21.3 Disposal of the chamber in the Federal Republic of Germany

According to Annex I of Directive 2012/19/EU of the European Parliament and of the Council on waste electrical and electronic equipment (WEEE), BINDER devices are classified as “monitoring and control instruments” (category 9) only intended for professional use“. They must not be disposed of at public collecting points.

The chambers bear the symbol for the marking of electrical and electronic equipment manufactured / placed on the market in the EC after 13 August 2005 and be disposed of in separate collection according to Directive 2012/19/EU on waste electrical and electronic equipment (WEEE) and German national law for electrical and electronic equipment (Elektro- und Elektronikgerätesgesetz, ElektroG). WEEE marking: crossed-out wheeled bin. A significant part of the materials must be recycled in order to protect the environment.

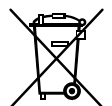



At the end of the device's service life, have the device disposed of according to the German national law for electrical and electronic equipment (Elektro- und Elektronikgerätegesetz, ElektroG from 20 October 2015, BGBl. I p. 1739) or contact BINDER service who will organize taking back and disposal of the chamber according to the German national law for electrical and electronic equipment (Elektro- und Elektronikgerätegesetz, ElektroG from 20 October 2015, BGBl. I p. 1739).

	NOTICE
	<p><b>Danger of violation against existing law if not disposed of properly.</b>  <b>Failure to comply with applicable law.</b></p> <ul style="list-style-type: none"> <li>∅ Do NOT dispose of BINDER devices at public collecting points.</li> <li>➤ Have the device disposed of professionally at a recycling company which is certified according to the German national law for electrical and electronic equipment (Elektro- und Elektronikgerätegesetz, ElektroG from 20 October 2015, BGBl. I p. 1739).</li> <li style="text-align: center;"><i>or</i></li> <li>➤ Instruct BINDER Service to dispose of the device. The general terms of payment and delivery of BINDER GmbH apply, which were valid at the time of purchasing the chamber.</li> </ul>

Certified companies disassemble waste (used) BINDER equipment in primary substances for recycling according to Directive 2012/19/EU. The devices must be free from toxic, infectious or radioactive substances in order to eliminate any health hazards to the employees of the recycling companies.

	<p>Prior to handing the chamber over to a recycling company, it is the user's responsibility that it is free from toxic, infectious or radioactive substances.</p> <ul style="list-style-type: none"> <li>• Prior to disposal, clean all introduced or residual toxic substances from the chamber.</li> <li>• Prior to disposal, disinfect the chamber from all sources of infection. Be aware that sources of infection may also be located outside the inner chamber.</li> <li>• If you cannot safely remove all toxic substances and sources of infection from the chamber, dispose of it as special waste according to national law.</li> <li>• Fill out the contamination clearance certificate (chap. 24) and enclose it with the chamber.</li> </ul>
---	---

 	 <b>WARNING</b>
	<p><b>Danger of intoxication and infection through contamination of the chamber with toxic, infectious or radioactive substances.</b>  <b>Damages to health.</b></p> <ul style="list-style-type: none"> <li>∅ NEVER take a chamber contaminated with toxic substances or sources of infection for recycling according to Directive 2012/19/EU.</li> <li>➤ Prior to disposal, remove all toxic substances and sources of infection from the chamber.</li> <li>➤ A chamber from which all toxic substances or sources of infection cannot be safely removed must be considered as "special" waste according to national law. Dispose of it accordingly.</li> </ul>

## 21.4 Disposal of the chamber in the member states of the EU except for the Federal Republic of Germany

According to Annex I of Directive 2012/19/EU of the European Parliament and of the Council on waste electrical and electronic equipment (WEEE), BINDER devices are classified as "monitoring and control instruments" (category 9) only intended for professional use". They must not be disposed of at public collecting points.



The chambers bear the symbol for the marking of electrical and electronic equipment manufactured / placed on the market in the EC after 13 August 2005 and be disposed of in separate collection according to the Directive 2012/19/EU on waste electrical and electronic equipment (WEEE). WEEE marking: crossed-out wheeled bin.

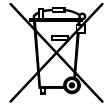



At the end of the device's service life, notify the distributor who sold you the device, who will take back and dispose of the chamber according to the Directive 2012/19/EU on waste electrical and electronic equipment (WEEE).



	<b>NOTICE</b>
	<p><b>Danger of violation against existing law if not disposed of properly.</b>  <b>Failure to comply with applicable law.</b></p> <ul style="list-style-type: none"> <li>Ø Do NOT dispose of BINDER devices at public collecting points.</li> <li>➤ Have the device disposed of professionally at a recycling company that is certified according to conversion of the Directive 2012/19/EU into national law.</li> <li style="text-align: center;"><i>or</i></li> <li>➤ Instruct the distributor who sold you the device to dispose of it. The agreements apply that were agreed with the distributor when purchasing the chamber (e.g. his general terms of payment and delivery).</li> <li>➤ If your distributor is not able to take back and dispose of the chamber, please contact BINDER service.</li> </ul>

Certified companies disassemble waste (used) BINDER equipment in primary substances for recycling according to Directive 2012/19/EU. The devices must be free from toxic, infectious or radioactive substances in order to eliminate any health hazards to the employees of the recycling companies.

	<p>Prior to handing the chamber over to a recycling company, it is the user's responsibility that it is free from toxic, infectious or radioactive substances.</p> <ul style="list-style-type: none"> <li>• Prior to disposal, clean all introduced or residual toxic substances from the chamber.</li> <li>• Prior to disposal, disinfect the chamber from all sources of infection. Be aware that sources of infection may also be located outside the inner chamber.</li> <li>• If you cannot safely remove all sources of infection and toxic substances from the chamber, dispose of it as special waste according to national law.</li> <li>• Fill out the contamination clearance certificate (chap. 24) and enclose it with the chamber.</li> </ul>
---	---

 	 <b>WARNING</b>
	<p><b>Danger of intoxication and infection through contamination of the chamber with toxic, infectious or radioactive substances.</b>  <b>Damages to health.</b></p> <ul style="list-style-type: none"> <li>Ø NEVER take a chamber contaminated with toxic substances or sources of infection for recycling according to Directive 2012/19/EU.</li> <li>➤ Prior to disposal, remove all toxic substances and sources of infection from the chamber.</li> <li>➤ A chamber from which all toxic substances or sources of infection cannot be safely removed must be considered as "special" waste according to national law. Dispose of it accordingly.</li> </ul>

## 21.5 Disposal of the chamber in non-member states of the EU

 	<p style="text-align: center;"><b>NOTICE</b></p> <p><b>Danger of violation against existing law if not disposed of properly.</b>  <b>Failure to comply with applicable law. Alteration of the environment.</b></p> <ul style="list-style-type: none"> <li>➤ For final decommissioning and disposal of the chamber, please contact BINDER service.</li> <li>➤ Follow the statutory regulations for appropriate, environmentally friendly disposal.</li> </ul>
---	--

## 22. Technical description

### 22.1 Factory calibration and adjustment

This chamber was calibrated and adjusted in the factory. Calibration and adjustment were performed using standardized test instructions, according to the QM DIN EN ISO 9001 system applied by BINDER (certified since December 1996 by TÜV CERT). All test equipment used is subject to the administration of measurement and test equipment that is also constituent part of the BINDER QM DIN EN ISO 9001 systems. They are controlled and calibrated to a DKD-Standard at regular intervals.

### 22.2 Definition of usable volume

The usable volume illustrated below is calculated as follows:

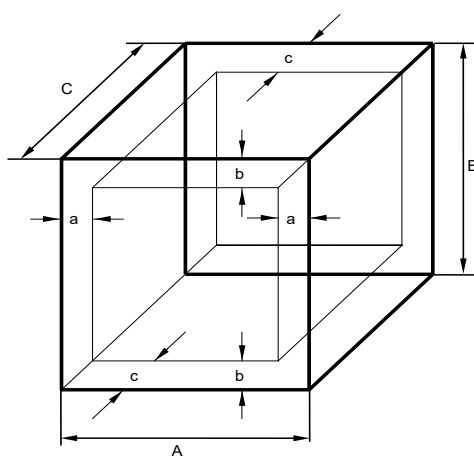

A, B, C = Internal dimensions (W, H, D)  
a, b, c = Wall clearances

$$a = 0.1 \times A$$

$$b = 0.1 \times B$$

$$c = 0.1 \times C$$

$$V_{USE} = (A - 2a) \times (B - 2b) \times (C - 2c)$$

Figure 16: Determination of the useable volume

**The technical data refers to the defined usable volume.**



Do NOT place samples outside this usable volume.  
Do NOT load this volume by more than half to enable sufficient airflow inside the chamber.  
Do NOT divide the usable volume into separate parts with large area samples.  
Do NOT place samples too close to each other in order to permit circulation between them and thus obtain a homogenous distribution of temperature.

## 22.3 Over current protection

**Single-phase devices** are protected by two miniature fuses against over current, accessible from the outside. The miniature fuses are located at the rear of the chamber above the power cable connection. Each fuse holder is equipped with a fuse clip 5mm x 20 mm. A fuse may be replaced only with a substitute of the same ratings. Refer to the technical data of the respective device type.

**Three-phase devices** are equipped with an internal miniature circuit breaker.

## 22.4 M technical data

Chamber size		M 56	M 115	M 260	M 720
<b>Exterior dimensions</b>					
Width, net	mm / inch	560 / 22.01	710 / 27.95	814 / 32.05	1165 / 45.87
Height, gross (incl. feet)	mm / inch	622 / 24.49	732 / 28.82	962 / 37.87	1589 / 62.56
Depth, net	mm / inch	596 / 23.46	636 / 25.04	786 / 30.94	816 / 32.13
Depth, gross (incl. door handle and exhaust duct)	mm / inch	648 / 25.51	690 / 27.17	840 / 33.07	870 / 34.25
Wall clearance rear (minimum)	mm / inch	160 / 6.30	160 / 6.30	160 / 6.30	160 / 6.30
Wall clearance side (minimum)	mm / inch	100 / 3.94	100 / 3.94	100 / 3.94	100 / 3.94
Exhaust duct, outer diameter	mm / inch	52 / 2.05	52 / 2.05	52 / 2.05	52 / 2.05
<b>Doors</b>					
Number of door(s)		1	1	1	2
<b>Interior dimensions</b>					
Width	mm / inch	400 / 15.75	550 / 21.65	650 / 25.59	1000 / 39.37
Height	mm / inch	440 / 17.32	550 / 21.65	780 / 30.71	1300 / 51.18
Depth	mm / inch	335 / 13.19	375 / 14.76	505 / 19.88	565 / 22.24
Interior volume	l / cu.ft.	59 / 2.32	113 / 4.45	256 / 10.08	735 / 28.94
Steam space volume	l / cu.ft.	67 / 2.37	127 / 4.49	279 / 9.85	789 / 27.86
<b>Racks</b>					
Quantity of racks (regular)		2	2	2	2
Quantity of racks (max.)		4	5	8	16
Max. load per rack (standard rack)	Kg / lbs	30 / 66	30 / 66	44 / 88	45 / 99
Max. load per rack (optional perforated shelf)	Kg / lbs	35 / 77	35 / 77	35 / 77	35 / 77
Max. load per rack (optional heavy load rack)	Kg / lbs	---	---	70 / 154	70 / 154
Permitted total load	Kg / lbs	70 / 154	150 / 330	270 / 595	315 / 694
Permitted total load, with reinforced inner chamber option	Kg / lbs	85 / 187	170 / 375	300 / 661	350 / 772
<b>Weight</b>					
Weight (empty)	Kg / lbs	43 / 95	58 / 128	86 / 190	170 / 375

Chamber size			M 56	M 115	M 260	M 720
<b>Temperature data</b>						
Temperature range	from ... degrees above ambient	°C / °F	23 / 41.4	23 / 41.4	14 / 25.2	14 / 25.2
	up to	°C / °F	300 / 572	300 / 572	300 / 572	300 / 572
Temperature fluctuation at 150 °C / 302 °F		± K	0,2	0,2	0,4	0,6
Temperature uniformity (variation) at 150 °C / 302 °F		± K	1,4	1,0	1,5	2,0
Heating up time to 150 °C / 302 °F		minutes	9	11	13	14
Recovery time after door was opened for 30 sec at 150 °C / 302 °F		minutes	4	6	6	6
<b>Ventilation data</b>						
Air change rate	at 100 °C / 212 °F	x/h	175	105	65	40
<b>Electrical data</b>						
System of protection acc. to EN 60529		IP	20	20	20	20
Nominal voltage (+/-10%)	at 50 Hz power frequency	V	230	230	400	400
	at 60 Hz power frequency	V	230	230	400	400
Current type			1N~	1N~	3N~	3N~
Nominal power		kW	2,00	2,40	3,10	6,00
Power plug of the power cable			IEC connector plug		CEE 16/6H	CEE 16/6H
			C13/C14	C19/C20		
Chamber fuse (external) 5x20 mm / 250V / time-lag (T)		A	10	12,5	---	---
Miniature circuit breaker (internal)		A	---	---	3x16	3x16
Overtemperature protective device class 1		°C	330	350	350	330
Installation category acc. to IEC 61010-1			II	II	II	II
Pollution degree acc. to IEC 61010-1			2	2	2	2
<b>Environment-specific data</b>						
Noise level (mean value)		dB (A)	46	46	46	49
Energy consumption at 150 °C / 302 °F		Wh/h	330	410	560	1025

All technical data is specified for unloaded chambers with standard equipment at an ambient temperature of +22 °C +/- 3 °C / 71.6 °F +/- 5.4 °F and a power supply voltage fluctuation of +/-10%. Technical data is determined in accordance to BINDER Factory Standard Part 2:2015 and DIN 12880:2007.

**All indications are average values, typical for chambers produced in series. We reserve the right to change technical specifications at any time.**



If the chamber is fully loaded, the specified heating up times may vary according to the load.

## 22.5 Equipment and options (extract)



To operate the chamber, use only original BINDER accessories or accessories / components from third-party suppliers authorized by BINDER. The user is responsible for any risk arising from using unauthorized accessories.

Standard equipment
Microprocessor display program controller with digital display and touchscreen
Disconnectable audible over-temperature alarm
Temperature safety controller class 2 or 3.1 acc. to DIN 12880:2007, selectable
FailSafe function
Zero-voltage relay alarm contact
Zero-voltage switching contact, control via program controller
USB interface to read out the measured values
Communication interface Ethernet
Exhaust duct, internal diameter 50 mm / 1.97 inches, with adjustable ventilation slide
Adjustable air change by means of rear exhaust duct (50 mm)
2 racks, chrome-plated

Options / accessories
Rack, chrome-plated or stainless steel
Perforated rack, stainless steel
Heavy load rack, stainless steel
Access ports with various diameters, with silicone plug
Door lock – lockable door handle
Rubber pads for safe stacking (5 pieces)
Object temperature display with additional Pt100 temperature sensor, to display the object temperature on the controller display
Object temperature control with additional Pt100 temperature sensor
Analog output 4-20 mA for temperature values (output not adjustable)
HEPA Fresh air filter at the fresh air access of the chamber, class H 14 (DIN EN 1822:2009)
Mostly gas-tight version. Option for chambers sizes 56, 115, 260. Not available in connection with the access ports option.
Inert gas connection (gas inlet and outlet), with mostly gas-tight version. Option for chambers sizes 56, 115, 260. Not available in connection with the access ports option.
FKM door gasket (temperature resistant up to 200 °C / 392 °F max.)
Measurement of air change rate acc. to ASTM D5374
Factory calibration certificate
Extension to factory calibration certificate (additional values)
Measuring protocol acc. to DIN 12880:2007
Qualification folder
Neutral cleaning agent (liquid concentrate)
Stable table on wheels with castors and locking brakes

## 22.6 Accessories and spare parts (extract)

	<p>BINDER GmbH is responsible for the safety features of the chamber only, provided skilled electricians or qualified personnel authorized by BINDER perform all maintenance and repair, and if components relating to chamber safety are replaced in the event of failure with original spare parts. The user is responsible for any risks arising from using unauthorized accessories/components.</p>
---	---

Chamber size	56	115	260	720
Description	Art. No.			
Rack, chrome-plated	8012-2038	8012-2040	8012-2042	8012-2044
Rack, stainless steel	8012-2085	8012-2168	8012-2169	8012-2170
Perforated rack, stainless steel	8012-2175	8012-2176	8012-2177	8012-2178
Rack, heavy load, stainless steel. Load per rack max. 70 kg	---	---	8012-2184	8012-2185
Door gasket, silicone	6005-0254	6005-0255	6005-0258	6005-0260
Door gasket made of FKM, silicon-free (temperature resistant up to 200 °C / 392 °F max.)	8012-2233	8012-2234	8012-2235	---
Stable table on wheels with castors and locking brakes, W 1000 x D 800 x H 780 mm	9051-0018	9051-0018	---	---
Stabiler Tischwagen mit Rollen und Feststellbremse, W 1300 x D 800 x H 780 mm	---	---	9051-0019	---
Chamber fuse 5x20mm 250V 10 A time lag (T)	5006-0079	---	---	---
Chamber fuse 5x20mm 250V 8,0 A time lag (T)	---	---	---	---
Chamber fuse 5x20mm 250V 12,5 A time lag (T)	---	5006-0096	---	---

Description	Art. No.
APT-COM™ 4 BASIC-Edition	9053-0039
APT-COM™ 4 PROFESSIONAL-Edition	9053-0040
APT-COM™ 4 GLP-Edition	9053-0042
HEPA fresh air filter (replacement) class H 14 (DIN EN 1822:2009)	6014-0003
Rubber pads for safe stacking (5 pieces)	8012-0001
Neutral cleaning agent, 1 kg	1002-0016

For information on components not listed here, please contact BINDER Service.

Validation service	Art. no.
Qualification folder IQ-OQ (printed version)	7007-0001
Qualification folder IQ-OQ (digital version)	7057-0001
Qualification folder IQ-OQ-PQ (printed version)	7007-0005
Qualification folder IQ-OQ-PQ (digital version)	7057-0005
Execution of IQ-OQ	DL420300
Execution of IQ-OQ-PQ	DL440500

Calibration service	Art.-No.
Calibration of temperature including certificate (1 measuring point in center of usable volume)	8012-2324
Spatial temperature measurement including certificate (9 measuring points)	8012-2327
Spatial temperature measurement including certificate (15 to 18 measuring points)	8012-2325
Spatial temperature measurement including certificate (27 measuring points)	8012-2326
Temperature calibration certificate - extension of the measurement in the center of usable volume to include a further test temperature	8012-2328
Measurement of air ventilation acc. to ASTM D 5374, including certificate	8012-2329

## 22.7 Dimensions size 56

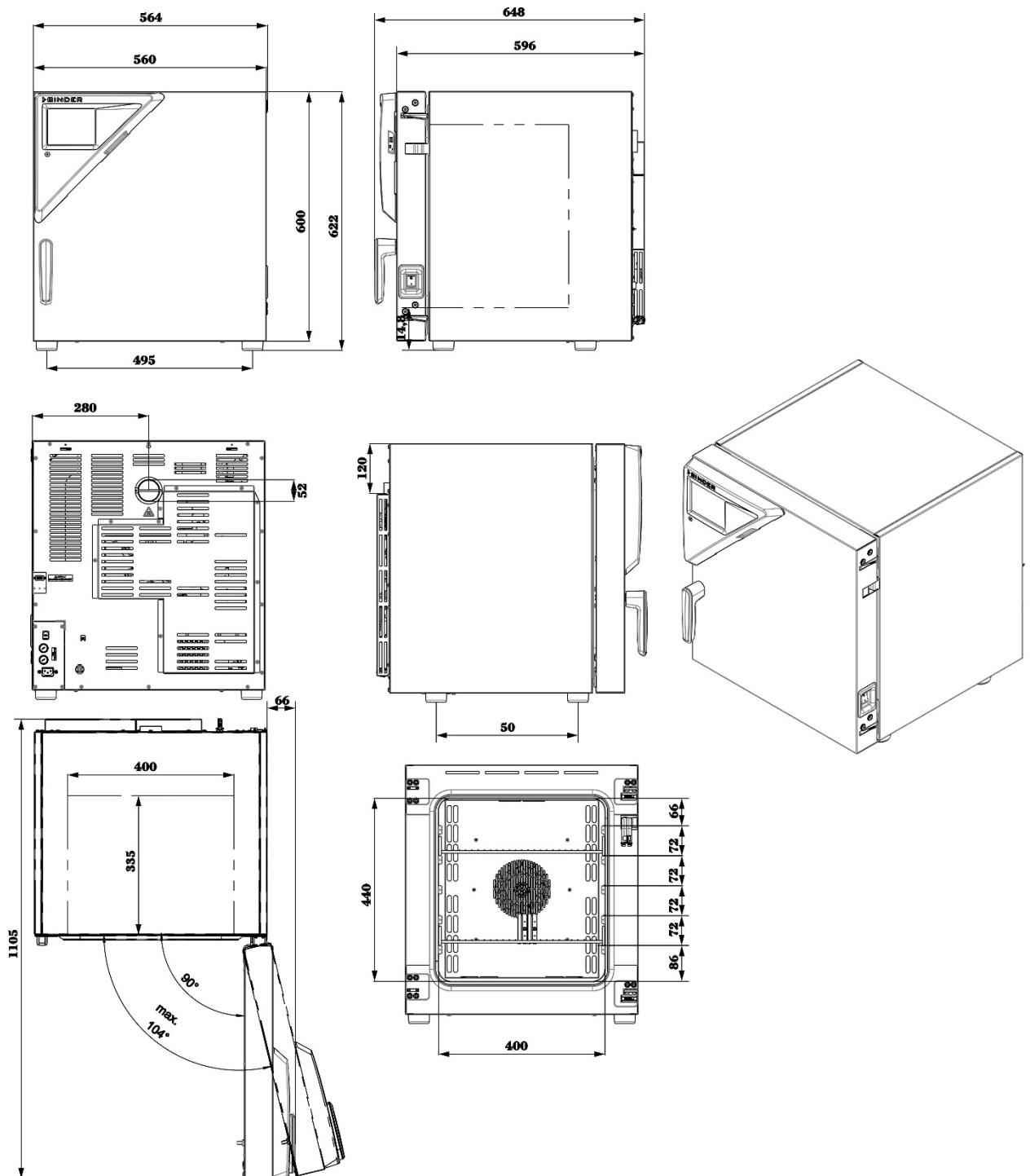

[Dimensions in mm]

## 22.8 Dimensions size 115

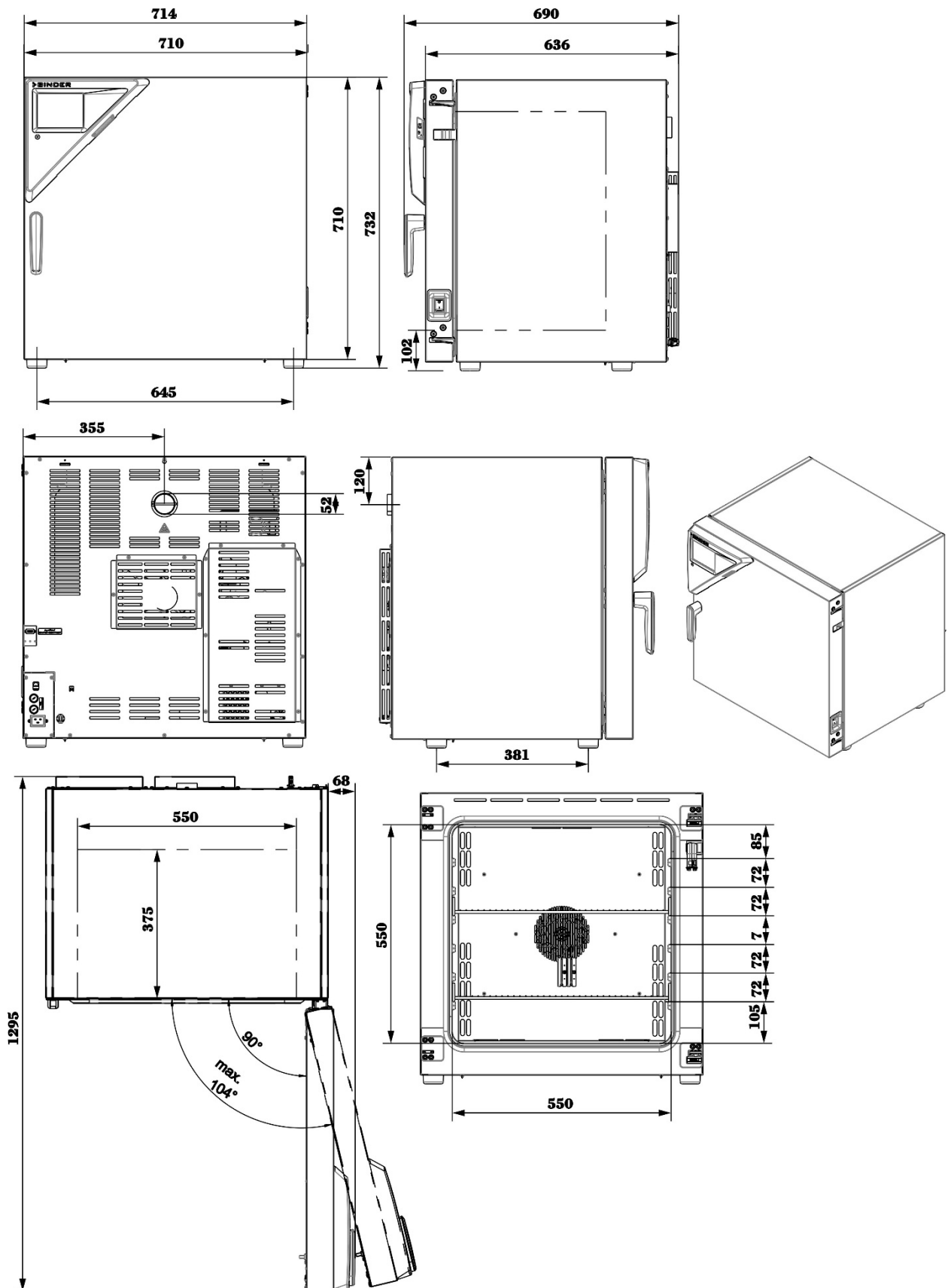

[Dimensions in mm]



## 22.9 Dimensions size 260

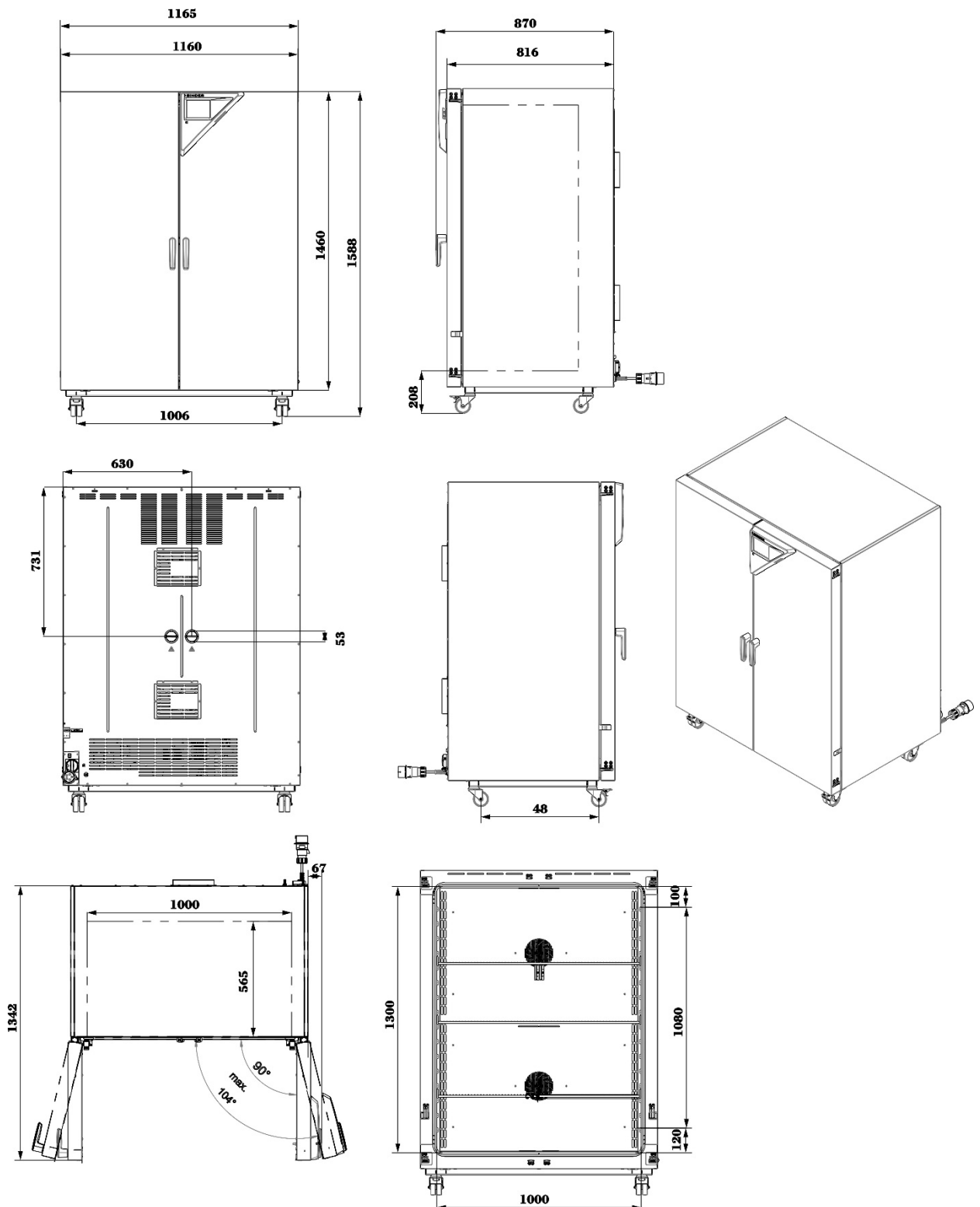

[ Dimensions in mm ]

## 22.10 Dimensions size 720

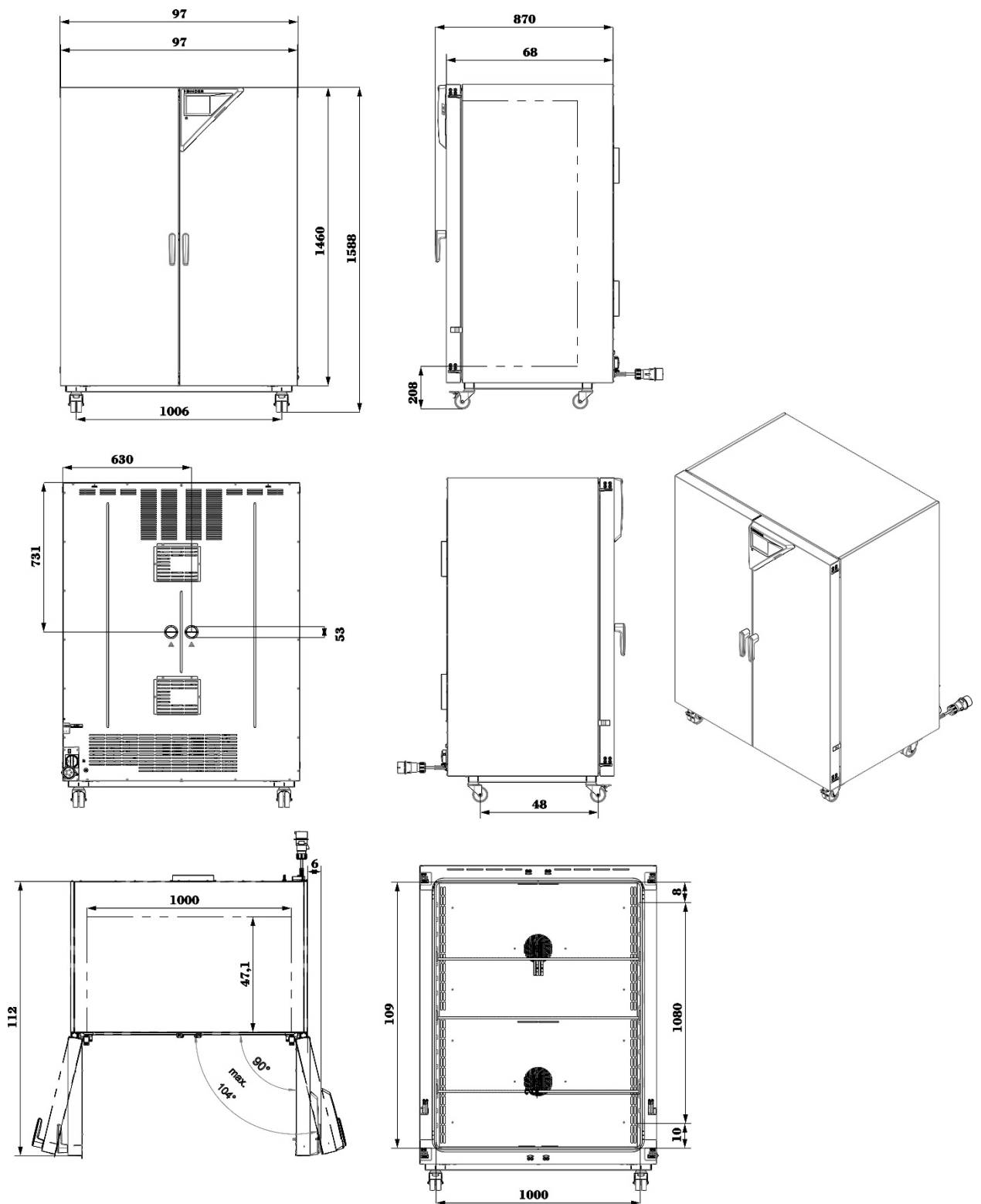

[ Dimensions in mm ]

## 23. Certificates and declarations of conformity

### 23.1 EU Declaration of Conformity



**CE** EU-Konformitätserklärung / EU Declaration of Conformity / Déclaration de conformité UE / Declaración de conformidad UE / Dichiarazione di conformità UE / Декларация соответствия EU

Hersteller / Manufacturer / Fabricant / Fabricante / Fabbricante / Производитель	BINDER GmbH
Anschrift / Address / Adresse / Dirección / Indirizzo / Адрес	Im Mittleren Ösch 5, 78532 Tuttlingen, Germany
Produkt / Product / Produit / Producto / Prodotto / Продукт	Trocken- und Wärmeschränke mit Umluft Drying and heating ovens with forced convection Etuves de chauffage et de séchage à convection forcée Estufas de secado y calentamiento con convección forzada Stufe per essiccazione e riscaldamento a convezione forzata Сушильные и сухожаровые шкафы с принудительной конвекцией
Typenbezeichnung / Type / Type / Tipo / Tipo / Тип	M 56, M 115, M 260, M 720 (E3.1)
Art. No. / Art. no. / Réf. / Art. N° / Art. n. / № арт.	9010-0371, 9010-0372, 9010-0373, 9010-0374 9110-0371, 9110-0372, 9110-0373, 9110-0374

Die oben beschriebenen Maschinen sind konform mit folgenden EG/EU-Richtlinien (gemäß Veröffentlichung im Amtsblatt der europäischen Kommission):

The machines described above are in conformity with the following EC/EU Directives (as published in the Official Journal of the European Union):

Les machines décrites ci-dessus sont conformes aux directives CE/UE suivantes (selon leur publication dans le Journal officiel de l'Union européenne):

La máquina descrita arriba cumple con las siguientes directivas de la CE/UE (publicados en el Diario oficial de la Unión Europea):

Le macchine sopra descritte sono conforme alle seguenti direttive CE/UE (secondo la pubblicazione nella Gazzetta ufficiale della Commissione europea):

Машина, указанная выше, полностью соответствует следующим регламентам ЕС/ЕУ (опубликованным в Официальном журнале Европейского Содружества):

- **2006/42/EC**  
Maschinenrichtlinie 2006/42/EG / Machinery directive 2006/42/EC / Directive Machines 2006/42/EC / Directiva 2006/42/CE (Máquinas) / Direttiva macchine 2006/42/CE / Директива о машинах 2006/42/EC
- **2014/30/EU**  
EMV-Richtlinie 2014/30/EU / EMC Directive 2014/30/EU / Directive CEM 2014/30/UE / Directiva CEM 2014/30/UE / Direttiva EMC 2014/30/UE / Директива ЭМС 2014/30/EU
- **2011/65/EU, (EU) 2015/863**  
RoHS-Richtlinien 2011/65/EU und (EU) 2015/863 / RoHS Directives 2011/65/EU and (EU) 2015/863 / Directives RoHS 2011/65/UE et (UE) 2015/863 / Directivas RoHS 2011/65/UE y (UE) 2015/863 / Direttive RoHS 2011/65/UE et (UE) 2015/863 / Директивы RoHS 2011/65/EU и (EU) 2015/863

1 / 3

BINDER GmbH  
Im Mittleren Ösch 5  
78502 Tuttlingen  
Deutschland

Tel: +49 (0) 74 62 / 20 05 - 0  
Fax: +49 (0) 74 62 / 20 05 - 100  
info@binder-world.com  
www.binder-world.com

Geschäftsführung:  
Dipl.-Ing. Peter M. Binder  
Amtsgericht Stuttgart, HRB 727150  
Sitz der Gesellschaft: Tuttlingen  
Ust.-ID.-Nr.: DE815021304

Kreissparkasse Tuttlingen  
IBAN: DE05 6435 0070 0000 0022 66  
SWIFT: SOLA DE 31TUT  
Deutsche Bank Tuttlingen  
IBAN: DE56 6537 0075 0213 8709 00  
SWIFT: DEUT DE 33653

Die oben beschriebenen Maschinen entsprechen aufgrund ihrer Konzipierung und Bauart sowie in der von uns in Verkehr gebrachten Ausführung den einschlägigen grundlegenden Sicherheits- und Gesundheitsanforderungen der genannten EG/EU-Richtlinien.

The machines described above are conform to the mentioned EC/EU directives in regard to the relevant safety and health demands due to their conception and style of construction as well as to the version put onto market by us.

Les machines décrites ci-dessus correspondent aux demandes de sécurité et de santé des directives citées de la CE/UE due à leur conception et construction et dans la réalisation mise sur le marché par nous.

Las máquinas descritas arriba se corresponden con los requisitos básicos pertinentes de seguridad y salud de las citadas directivas de la CE/UE debido a su concepción y fabricación, así como a la realización llevada a cabo por nosotros.

Le macchine sopra descritte sono conforme ai requisiti essenziali di sanità e sicurezza pertinenti delle summenzionate direttive CE/UE in termini di progettazione, tipo di costruzione ed esecuzione messa da noi in circolazione.

Машины описано выше, соответствует указанным директивам ЕС/ЕУ в отношении требований соответствующей безопасности и здоровья по концепции и конструкции так же как и версия, применяемая нами на рынке.

Die oben beschriebenen Maschinen tragen entsprechend die Kennzeichnung CE.

The machines described above, corresponding to this, bear the CE-mark.

Les machines décrits ci-dessus, en correspondance, portent l'indication CE.

Las máquinas descritas arriba, en conformidad, llevan la indicación CE.

Le macchine sopra descritte sono contrassegnate dal marchio CE.

Машины описано выше, в соответствии с изложенным выше маркированы знаком CE.

Die oben beschriebenen Maschinen sind konform mit folgenden harmonisierten Normen:

The machines described above are in conformity with the following harmonized standards:

Les machines décrits ci-dessus sont conformes aux normes harmonisées suivantes :

Las máquinas descritas arriba cumplen con las siguientes normas:

Le macchine sopra descritte sono conforme alle seguenti normative armonizzate:

Машины описано выше, полностью соответствуют следующим стандартам:

2 / 3

BINDER GmbH  
Im Mittleren Osch 5  
78502 Tuttlingen  
Deutschland

Tel: +49 (0) 74 62 / 20 05 - 0  
Fax: +49 (0) 74 62 / 20 05 - 100  
info@binder-world.com  
www.binder-world.com

Geschäftsführung:  
Dipl.-Ing. Peter M. Binder  
Amtsgericht Stuttgart, HRB 727150  
Sitz der Gesellschaft: Tuttlingen  
Ust.-ID.-Nr.: DE815021304

Kreissparkasse Tuttlingen  
IBAN: DE05 6435 0070 0000 0022 66  
SWIFT: SOLA DE 31TUT  
Deutsche Bank Tuttlingen  
IBAN: DE56 6537 0075 0213 8709 00  
SWIFT: DEUT DE 33653

Sicherheit / Safety / Sécurité / Seguridad / Sicurezza / Нормативы по безопасности
<ul style="list-style-type: none"><li>• EN ISO 12100:2010 + Corr. 1:2011</li><li>• EN ISO 13732-1:2008</li><li>• EN 60204-1:2018</li></ul>
EMV / EMC / CEM / CEM / EMC / ЭМС
<ul style="list-style-type: none"><li>• EN 61326-1:2013</li></ul>
RoHS
<ul style="list-style-type: none"><li>• EN IEC 63000:2018</li></ul>

78532 Tuttlingen, 28.08.2023

BINDER GmbH



P. Wimmer  
Vice President  
Vice President  
Vice président  
Vicepresidente  
Vicepresidente  
Вице-президент



J. Bollaender  
Leiter F & E und Dokumentationsbevollmächtigter  
Director R & D and documentation representative  
Chef de service R&D et autorisé de documentation  
Responsable I & D y representante de documentación  
Direttore R & D e responsabile della documentazione  
Глава департамента R&D представитель документации

BINDER GmbH  
Im Mittleren Osch 5  
78502 Tuttlingen  
Deutschland

Tel: +49 (0) 74 62 / 20 05 - 0  
Fax: +49 (0) 74 62 / 20 05 - 100  
info@binder-world.com  
www.binder-world.com

Geschäftsführung:  
Dipl.-Ing. Peter M. Binder  
Amtsgericht Stuttgart, HRB 727150  
Sitz der Gesellschaft: Tuttlingen  
Ust.-ID.-Nr.: DE815021304

Kreissparkasse Tuttlingen  
IBAN: DE05 6435 0070 0000 0022 66  
SWIFT: SOLA DE 31TUT  
Deutsche Bank Tuttlingen  
IBAN: DE56 6537 0075 0213 8709 00  
SWIFT: DEUT DE 33653

## 23.2 UKCA Declaration of Conformity



<b>UK CA</b>	<b>UKCA Declaration of Conformity</b>
------------------	---------------------------------------

Name and address of manufacturer	BINDER GmbH Im Mittleren Ösch 5, 78532 Tuttlingen, Germany
Name and address of UK Authorised Representative	Comply Express Ltd Unit C2, Coalport House, Stafford Park 1, Telford TF3 3BD
Object of the Declaration	Drying and heating ovens with forced convection
Type Designation	M 56, M 115, M 260, M 720 (E3.1)
BINDER Art. No.	9010-0371, 9010-0372, 9010-0373, 9010-0374 9110-0371, 9110-0372, 9110-0373, 9110-0374



The Objects of the Declaration described above are in conformity with the relevant UK Regulations and UK Guidelines:

- **Supply of Machinery (Safety) Regulations 2008**  
Statutory Instruments 2008 No. 1597 – Health and safety
- **Electromagnetic Compatibility Regulations 2016**  
Statutory Instruments 2016 No. 1091 – Electromagnetic Compatibility
- **The Restriction of the Use of Certain Hazardous Substances in Electrical and Electronic Equipment Regulations 2012**  
Statutory Instruments 2012 No. 3032 – Environmental Protection

References of standards and/or technical specifications applied for this Declaration of Conformity, or parts thereof:

<b>S.I. 2008 No. 1597:</b>	EN ISO 12100:2010 EN ISO 13732-1:2008 EN 60204-1:2018
<b>S.I. 2016 No. 1091:</b>	EN 61326-1:2013
<b>S.I. 2012 No. 3032:</b>	EN IEC 63000:2018

This Declaration is issued under the sole responsibility of the manufacturer.

Tuttlingen	28.08.2023			
Place	Date	P. Wimmer Vice President	J. Bollaender Director R & D	BINDER GmbH

BINDER GmbH  
Im Mittleren Ösch 5  
78502 Tuttlingen  
Deutschland

Tel: +49 (0) 74 62 / 20 05 - 0  
Fax: +49 (0) 74 62 / 20 05 - 100  
info@binder-world.com  
www.binder-world.com

Geschäftsführung:  
Dipl.-Ing. Peter M. Binder  
Amtsgericht Stuttgart, HRB 727150  
Sitz der Gesellschaft: Tuttlingen  
Ust.-ID.-Nr.: DE815021304

Kreissparkasse Tuttlingen  
IBAN: DE05 6435 0070 0000 0022 66  
SWIFT: SOLA DE 31TUT  
Deutsche Bank Tuttlingen  
IBAN: DE56 6537 0075 0213 8709 00  
SWIFT: DEUT DE 33653

## 23.3 Certificate for the GS mark of conformity of the “Deutsche Gesetzliche Unfallversicherung e.V.” (German Social Accident Insurance) DGUV

Zertifikat  
Nr. **NV 23179**  
vom 21.09.2023



### GS-Zertifikat

Name und Anschrift des Zertifikatsinhabers: (Auftraggeber)	<b>Binder GmbH</b> Im Mittleren Ösch 5 78532 Tuttlingen
Produktbezeichnung:	<b>Drying and heating oven</b>
Typ:	M 56, M 115, M 260, M 720
Prüfgrundlage:	GS-NV 5:2019/08 Prüfgrundsätze für Kühl- und Gefriermaschinen für Industrie und Gewerbe
Zugehöriger Prüfbericht:	Prüfbericht zum Zertifikat NV 23179
Weitere Angaben:	Das Zertifikat bezieht sich auf die im zugehörigen Prüfbericht beschriebene Ausführung des Produkts.

Das geprüfte Baumuster stimmt mit den in § 21 Absatz 1 des Produktsicherheitsgesetzes genannten Anforderungen überein. Der Zertifikatsinhaber ist berechtigt, das umseitig abgebildete GS-Zeichen an den mit dem geprüften Baumuster übereinstimmenden Produkten anzubringen. Der Zertifikatsinhaber hat dabei die umseitig aufgeführten Bedingungen zu beachten.

Dieses Zertifikat einschließlich der Berechtigung zur Anbringung des GS-Zeichens ist gültig bis einschließlich:

**20.09.2028**

Weiteres über die Gültigkeit, eine Gültigkeitsverlängerung und andere Bedingungen regelt die Prüf- und Zertifizierungsordnung.



Unterschrift (Zertifizierer)

Rückseite GS-Zertifikat: NV 23179

### GS-Zeichen



NV 23179

Normalausführung



NV 23179

dguv.de/dguv-test

Bei einer Höhe von 20 mm oder weniger  
auch zulässige Ausführung

1. Der Zertifikatsinhaber hat die Voraussetzungen einzuhalten, die bei der Herstellung des umseitig genannten Produktes zu beachten sind, um die Übereinstimmung mit dem geprüften Baumuster zu gewährleisten.
2. Die Prüf- und Zertifizierungsstelle des Fachbereichs Nahrungsmittel führt in regelmäßigen Abständen Kontrollmaßnahmen zur Überwachung der Herstellung und rechtmäßigen Verwendung des GS-Zeichens durch.
3. Die für die Herstellung verantwortliche Person hat sich zur Einhaltung der Voraussetzungen nach Nummer 1 und Duldung der Kontrollmaßnahmen verpflichtet.
4. Die Prüf- und Zertifizierungsstelle entzieht dem Zertifikatsinhaber die Zuerkennung des GS-Zeichens, wenn sich die Anforderungen nach § 21 Absatz 1 Produktsicherheitsgesetz geändert haben oder die Voraussetzungen nach Nummer 1 nicht eingehalten werden.
5. Das GS-Zeichen darf nur verwendet und mit ihm darf nur geworben werden, wenn die Voraussetzungen nach § 22 Produktsicherheitsgesetz erfüllt sind.



## 24. Contamination clearance certificate

### 24.1 For chambers located outside the USA and Canada

#### Declaration with regard to safety and health

Erklärung zur Sicherheit und gesundheitlichen Unbedenklichkeit

The German Ordinance on Hazardous Substances (GefStofV), and the regulations regarding safety at the workplace, require that this form be filled out for all products that are returned to us, so that the safety and health of our employees can be warranted.

Die Sicherheit und Gesundheit unserer Mitarbeiter, die Gefahrstoffverordnung GefStofV und die Vorschriften zur Sicherheit am Arbeitsplatz machen es erforderlich, dass dieses Formblatt für alle Produkte, die an uns zurückgeschickt wird.



In the absence of a completely filled out form, a repair is not possible.  
Ohne Vorliegen des vollständig ausgefüllten Formblattes ist eine Reparatur nicht möglich.

- A completely filled out form should be transmitted by Fax (+49 (0) 7462 2005 93555) or by letter in advance to us, so that this information is available before the equipment/component part arrives. A second copy of this form should accompany the equipment/component part. Eventually the carrier should be informed.

Eine vollständig ausgefüllte Kopie dieses Formblattes soll per Telefax (Nr. +49 (0) 7462 2005 93555) oder Brief vorab an uns gesandt werden, so dass die Information vorliegt, bevor das Gerät/Bauteil eintrifft. Eine weitere Kopie soll dem Gerät/Bauteil beigelegt sein. Ggf. ist auch die Spedition zu informieren.

- Incomplete information or non-conformity with this procedure will inevitably lead to substantial delays in processing. We hope you will have understanding for this measure, which lies outside of our area of influence, and that you will help us to speed up this procedure.

Unvollständige Angaben oder Nichteinhalten dieses Ablaufs führen zwangsläufig zu beträchtlichen Verzögerungen in der Abwicklung. Bitte haben Sie Verständnis für Maßnahmen, die außerhalb unserer Einflussmöglichkeiten liegen und helfen Sie mit, den Ablauf beschleunigen.

- **Please fill out this form completely.**

**Bitte unbedingt vollständig ausfüllen!**

<b>1.</b>	<b>Chamber/ component part / type: / Gerät / Bauteil / Typ:</b>
<b>2.</b>	<b>Serial No./ Serien-Nr.:</b>
<b>3.</b>	<b>Details about utilized substances / biological substances / Einzelheiten über die eingesetzten Substanzen/biologische Materialien:</b>
<b>3.1</b>	<b>Designations / Bezeichnungen:</b>
a)	_____
b)	_____
c)	_____
<b>3.2</b>	<b>Safety measures required for handling these substances / Vorsichtsmaßnahmen beim Umgang mit diesen Stoffen:</b>
a)	_____
b)	_____
c)	_____

<b>3.3</b>	<b>Measures to be taken in case of skin contact or release into the atmosphere / Maßnahmen bei Personenkontakt oder Freisetzung:</b>
a)	_____
b)	_____
c)	_____
d)	_____
<b>3.4</b>	<b>Other important information that must be taken into account / Weitere zu beachtende und wichtige Informationen:</b>
a)	_____
b)	_____
c)	_____
<b>4.</b>	<b>Declaration on the risk of these substances (please checkmark the applicable items) / Erklärung zur Gefährlichkeit der Stoffe (bitte Zutreffendes ankreuzen) :</b>
<input type="checkbox"/>	<b>4.1 For non toxic, non radioactive, biologically harmless materials / für nicht giftige, nicht radioaktive, biologisch ungefährliche Stoffe:</b>
	<b>We herewith guarantee that the above-mentioned chamber / component part... / Wir versichern, dass o.g. Gerät/Bauteil...</b>
<input type="checkbox"/>	Has not been exposed to or contains any toxic or otherwise hazardous substances / weder giftige noch sonstige gefährliche Stoffe enthält oder solche anhaften.
<input type="checkbox"/>	That eventually generated reaction products are non-toxic and also do not represent a hazard / auch evtl. entstandene Reaktionsprodukte weder giftig sind noch sonst eine Gefährdung darstellen.
<input type="checkbox"/>	Eventual residues of hazardous substances have been removed / evtl. Rückstände von Gefahrstoffen entfernt wurden.
<input type="checkbox"/>	<b>4.2 For toxic, radioactive, biologically harmful or hazardous substances, or any other hazardous materials / für giftige, radioaktive, biologisch bedenkliche bzw. gefährliche Stoffe oder anderweitig gefährliche Stoffe.</b>
	<b>We herewith guarantee that ... / Wir versichern, dass ...</b>
<input type="checkbox"/>	The hazardous substances, which have come into contact with the above-mentioned equipment/component part, have been completely listed under item 3.1 and that all information in this regard is complete / die gefährlichen Stoffe, die mit dem o.g. Gerät/Bauteil in Kontakt kamen, in 3.1 aufgelistet sind und alle Angaben vollständig sind.
<input type="checkbox"/>	That the chamber /component part has not been in contact with radioactivity / das Gerät/Bauteil nicht mit Radioaktivität in Berührung kam
<b>5.</b>	<b>Kind of transport / transporter / Transportweg/Spediteur:</b>
	Transport by (means and name of transport company, etc.) Versendung durch (Name Spediteur o.ä.)
	_____
	Date of dispatch to BINDER GmbH / Tag der Absendung an BINDER GmbH:
	_____

**We herewith declare that the following measures have been taken / Wir erklären, dass folgende Maßnahmen getroffen wurden:**

- Hazardous substances were removed from the chamber / component part, so that no hazard exists for corresponding persons in the handling or repair of these items / das Gerät/Bauteil wurde von Gefahrstoffen befreit, so dass bei Handhabung/Reparaturen für die betreffenden Person keinerlei Gefährdung besteht
- The chamber was securely packaged and properly identified / das Gerät wurde sicher verpackt und vollständig gekennzeichnet.
- Information about the hazardousness of the shipment (if required) has been provided to the transporter / der Spediteur wurde (falls vorgeschrieben) über die Gefährlichkeit der Sendung informiert.

We herewith commit ourselves and guarantee that we will indemnify BINDER GmbH for all damages that are a consequence of incomplete or incorrect information provided by us, and that we will exempt BINDER GmbH from eventual damage claims by third parties. / Wir versichern, dass wir gegenüber BINDER für jeden Schaden, der durch unvollständige und unrichtige Angaben entsteht, haften und BINDER gegen eventuell entstehende Schadensansprüche Dritter freistellen.

We are aware that, in accordance with Article 823 of the German Civil Code (BGB), we are directly liable with regard to third parties, in this instance especially the employees of BINDER GmbH, who have been entrusted with the handling / repair of the chamber / component. / Es ist uns bekannt, dass wir gegenüber Dritten – hier insbesondere mit der Handhabung/Reparatur des Geräts/des Bauteils betraute Mitarbeiter der Firma BINDER - gemäß §823 BGB direkt haften

Name: \_\_\_\_\_

Position: \_\_\_\_\_

Date / Datum: \_\_\_\_\_

Signature / Unterschrift: \_\_\_\_\_

Company stamp / Firmenstempel:



Equipment that is returned to the factory for repair must be accompanied by a completely filled out contamination clearance certificate. For service and maintenance works on site, such a contamination clearance certificate must be submitted to the service technician before the start of the works. No repair or maintenance of the equipment is possible, without a properly filled out contamination clearance certificate.

## 24.2 For chambers located in the USA and Canada

### Product Return Authorization Request

Please complete this form and the Customer Decontamination Declaration (next 2 pages) and attach the required pictures. E-mail to: IDL\_SalesOrderProcessing\_USA@binder-world.com

After we have received and reviewed the complete information we will decide on the issue of a RMA number. Please be aware that size specifications, voltage specifications as well as performance specifications are available on the internet at [www.binder-world.us](http://www.binder-world.us) at any time.

Take notice of shipping laws and regulations.

	Please fill:	
Reason for return request	<input type="radio"/> Duplicate order	
	<input type="radio"/> Duplicate shipment	
	<input type="radio"/> Demo	<i>Page one completed by sales</i>
	<input type="radio"/> Power Plug / Voltage	115V / 230 V / 208 V / 240V
	<input type="radio"/> Size does not fit space	
	<input type="radio"/> Transport Damage	Shock watch tripped? ( <i>pictures</i> )
	<input type="radio"/> Other (specify below)	
	_____	
Is there a replacement PO?	<input type="radio"/> Yes <input type="radio"/> No	
<i>If yes -&gt; PO #</i>		
<i>If yes -&gt; Date PO placed</i>		
Purchase order number		
BINDER model number		
BINDER serial number		
Date chamber was received		
Was the chamber unboxed?	<input type="radio"/> Yes <input type="radio"/> No	
Was the chamber plugged in?	<input type="radio"/> Yes <input type="radio"/> No	
Was the chamber in operation?	<input type="radio"/> Yes <input type="radio"/> No	
<i>Pictures of chamber attached?</i>	<input type="radio"/> Yes <input type="radio"/> No	Pictures have to be attached!
<i>Pictures of Packaging attached?</i>	<input type="radio"/> Yes <input type="radio"/> No	

	Customer Contact Information	Distributor Contact Information
Name		
Company		
Address		
Phone		
E-mail		

## Customer (End User) Decontamination Declaration

### Health and Hazard Safety declaration

To protect the health of our employees and the safety at the workplace, we require that this form is completed by the user for all products and parts that are returned to us. (Distributors or Service Organizations cannot sign this form)



NO RMA number will be issued without a completed form. Products or parts returned to our NY warehouse without a RMA number will be refused at the dock.

A second copy of the completed form must be attached to the outside of the shipping box.

<b>1.</b>	<b>Chamber/ component part / type:</b>
<b>2.</b>	<b>Serial No.</b>
<b>3.</b>	<b>List any exposure to hazardous liquids, gasses or substances and radioactive material</b>
<b>3.1</b>	<b>List with MSDS sheets attached where available or needed (if there is not enough space available below, please attach a page):</b>
a)	_____
b)	_____
c)	_____
<b>3.2</b>	<b>Safety measures required for handling the list under 3.1</b>
a)	_____
b)	_____
c)	_____
<b>3.3</b>	<b>Measures to be taken in case of skin contact or release into the atmosphere:</b>
a)	_____
b)	_____
c)	_____
d)	_____
<b>3.4</b>	<b>Other important information that must be considered:</b>
a)	_____
b)	_____
c)	_____

**4. Declaration of Decontamination**

**For toxic, radioactive, biologically and chemically harmful or hazardous substances, or any other hazardous materials.**

**We hereby guarantee that**

- 4.1 Any hazardous substances, which have come into contact with the above-mentioned equipment / component part, have been completely listed under item 3.1 and that all information in this regard is complete.
- 4.2 That the chamber /component part has not been in contact with radioactivity
- 4.3 Any Hazardous substances were removed from the chamber / component part, so that no hazard exists for a persons in the shipping, handling or repair of these returned chamber
- 4.4 The chamber was securely packaged in the original undamaged packaging and properly identified on the outside of the packaging material with the chamber designation, the RMA number and a copy of this declaration.
- 4.5 Shipping laws and regulations have not been violated.

**I hereby commit and guarantee that we will indemnify BINDER Inc. for all damages that are a consequence of incomplete or incorrect information provided by us, and that we will indemnify and hold harmless BINDER Inc. from eventual damage claims by third parties.**

Name: \_\_\_\_\_

Position: \_\_\_\_\_

Company: \_\_\_\_\_

Address: \_\_\_\_\_

Phone #: \_\_\_\_\_

Email: \_\_\_\_\_

Date: \_\_\_\_\_

Signature: \_\_\_\_\_



Equipment returned to the NY warehouse for repair must be accompanied by a completed customer decontamination declaration. For service and maintenance works on site, such a customer decontamination declaration must be submitted to the service technician before the start of work. No repair or maintenance of the equipment is possible without a completed form.

