

# Operating Manual

Translation of the original operating manual

## FP (E3.1)

### Drying and heating ovens

### Avantgarde.Line

### with forced convection and program functions

with microprocessor temperature controller

Model	Model version	Art. No.
FP 56 (E3.1)	FP056-230V	9010-0363, 9110-0363
FP 115 (E3.1)	FP115-230V	9010-0364, 9110-0364
FP 260 (E3.1)	FP260-230V	9010-0365, 9110-0365
FP 720 (E3.1)	FP720-400V	9010-0366, 9110-0366
FP 056-UL (E3.1)	FP056-120V	9010-0367, 9110-0367
FP 115-UL (E3.1)	FP115-120V	9010-0368, 9110-0368
FP 260-UL (E3.1)	FP260-240V	9010-0369, 9110-0369
FP 720-UL (E3.1)	FP720-208V	9010-0370, 9110-0370

#### **BINDER GmbH**

- ▶ Address: Post office box 102, 78502 Tuttlingen, Germany ▶ Phone: +49 7462 2005 0
- ▶ Fax: +49 7462 2005 100 ▶ Internet: <http://www.binder-world.com>
- ▶ Service Hotline: +49 7462 2005 555
- ▶ Service Fax: +49 7462 2005 93 555
- ▶ Service Hotline USA: +1 866 885 9794 or +1 631 224 4340 x3
- ▶ Service Hotline Asia Pacific: +852 390 705 04 or +852 390 705 03

## Content

<b>1. SAFETY</b>	<b>5</b>
1.1 Personnel Qualification	5
1.2 Operating manual	5
1.3 Legal considerations	5
1.3.1 Intellectual property	6
1.4 Structure of the safety instructions	6
1.4.1 Signal word panel	6
1.4.2 Safety alert symbol	7
1.4.3 Pictograms	7
1.4.4 Word message panel structure	8
1.5 Localization / position of safety labels on the chamber	8
1.6 Type plate	9
1.7 UKCA Label	10
1.8 General safety instructions on installing and operating the chambers	10
1.9 Intended use	12
1.10 Foreseeable Misuse	13
1.11 Residual Risks	14
1.12 Operating instructions	15
1.13 Measures to prevent accidents	15
<b>2. CHAMBER DESCRIPTION</b>	<b>17</b>
2.1 Chamber overview	18
2.2 Chamber rear	19
2.3 Triangular instrument panel	20
2.4 Main power switch on the chamber rear (size 720)	20
2.5 Zero-voltage switching contacts	20
<b>3. COMPLETENESS OF DELIVERY, TRANSPORTATION, STORAGE, AND INSTALLATION</b>	<b>21</b>
3.1 Unpacking, and checking equipment and completeness of delivery	21
3.2 Guidelines for safe lifting and transportation	22
3.3 Storage	22
3.4 Location of installation and ambient conditions	22
<b>4. INSTALLATION</b>	<b>24</b>
4.1 Electrical connection	24
4.2 Connection to an exhaust/ventilation system (optional)	25
4.3 Inserting the racks	25
<b>5. FUNCTIONAL OVERVIEW AND MENU STRUCTURE OF THE RD4 CHAMBER CONTROLLER</b>	<b>26</b>
5.1 Menu structure of the controller and access levels	27
5.2 Performance during and after power failures	28
5.3 Behavior when opening the door	28
<b>6. START UP</b>	<b>28</b>
6.1 Loading	28
6.2 Controller settings upon start up	29
6.3 Setting the displayed decimal places	29
<b>7. SET-POINT ENTRY</b>	<b>30</b>
7.1 Temperature set-point entry	30
7.2 Fan speed set-point entry	30
7.3 Adjusting the air flap position	30

<b>8.</b>	<b>SETTING SPECIAL CONTROLLER FUNCTIONS .....</b>	<b>31</b>
<b>9.</b>	<b>AUTHORIZATION LEVELS AND PASSWORD PROTECTION .....</b>	<b>33</b>
9.1	Password request .....	33
9.2	Assign and modify a password .....	33
9.2.1	Assign and modify the User password .....	33
9.2.2	Assign and modify the Admin password .....	34
<b>10.</b>	<b>FAILSAFE FUNCTION.....</b>	<b>34</b>
<b>11.</b>	<b>OVERTEMPERATURE PROTECTION .....</b>	<b>35</b>
11.1	Overtemperature protective device class 1.....	35
11.2	Overtemperature safety controller class 2 / 3.1 .....	36
11.2.1	Selecting between safety controller class 2 (temperature limiter) or class 3.1 .....	37
11.2.2	Safety controller mode.....	37
11.2.3	Setting the safety controller mode.....	37
11.2.4	Setting the safety controller value .....	38
11.2.5	Message and measures in the state of alarm .....	38
11.3	Function check .....	39
<b>12.</b>	<b>GENERAL CONTROLLER SETTINGS.....</b>	<b>39</b>
12.1	Selecting the controller's menu language .....	39
12.2	Selecting the temperature unit .....	40
12.3	Setting the current date.....	40
12.4	Setting the current time .....	41
12.5	Function "Language selection at restart" .....	41
12.6	Setting the chamber address .....	42
12.7	Display brightness .....	42
<b>13.</b>	<b>TOLERANCE RANGE SETTINGS.....</b>	<b>43</b>
13.1	Setting the delay time for tolerance range alarm .....	43
13.2	Setting the temperature tolerance range .....	43
<b>14.</b>	<b>NOTIFICATION AND ALARM FUNCTIONS .....</b>	<b>44</b>
14.1	Information messages.....	44
14.2	Alarm messages .....	44
14.3	Activating / deactivating the audible alarm (alarm buzzer) .....	45
14.4	Zero-voltage relay alarm contact .....	46
<b>15.</b>	<b>PROGRAM START / STOP FUNCTION .....</b>	<b>47</b>
15.1	Start time program .....	47
15.2	Start week program .....	47
15.3	Stop program .....	48
<b>16.</b>	<b>ETHERNET NETWORK SETTINGS .....</b>	<b>48</b>
16.1	Showing the network settings .....	48
16.1.1	Showing the chamber's MAC address .....	48
16.1.2	Showing the IP address.....	49
16.1.3	Showing the subnet mask .....	49
16.1.4	Showing the standard gateway .....	49
16.1.5	Showing the DNS server address .....	50
16.1.6	Showing the DNS chamber name .....	50
16.2	Changing the configuration of the network settings.....	50
16.2.1	Selecting the type of IP address assignment (automatic / manual) .....	51
16.2.2	Selecting the type of assignment of the DNS server address (automatic / manual).....	51
16.2.3	Assigning the IP address.....	51
16.2.4	Setting the subnet mask.....	52
16.2.5	Setting the standard gateway .....	53
16.2.6	Assigning the DNS server address .....	53

<b>17. DATA RECORDER .....</b>	<b>53</b>
17.1 Recorded data .....	54
17.2 Storage capacity .....	54
17.3 Setting the storage rate for the “DL1” recorder data .....	54
17.4 Deleting the data recorder .....	55
<b>18. USB MENU: DATA TRANSFER VIA USB INTERFACE .....</b>	<b>55</b>
18.1 Connecting the USB stick .....	55
18.2 Import function .....	56
18.3 Export functions .....	56
18.4 Ongoing data transfer .....	56
18.5 Error during data transmission .....	57
18.6 Removing the USB stick .....	57
<b>19. OPTIONS .....</b>	<b>57</b>
19.1 APT-COM™ 4 Multi Management Software (option) .....	57
19.2 Object temperature display with flexible Pt100 temperature sensor (option) .....	57
19.3 Analog output for temperature (option) .....	58
19.4 HEPA fresh air filter (option) .....	58
19.5 Mostly gas-tight version (option) .....	58
19.6 Inert gas connection with mostly gas-tight version (option) .....	59
<b>20. CLEANING AND DECONTAMINATION .....</b>	<b>61</b>
20.1 Cleaning .....	61
20.2 Decontamination / chemical disinfection .....	63
<b>21. MAINTENANCE AND SERVICE, TROUBLESHOOTING, REPAIR, TESTING... 64</b>	<b>64</b>
21.1 General information, personnel qualification .....	64
21.2 Maintenance intervals, service .....	64
21.3 Simple troubleshooting .....	65
21.4 Sending the chamber back to BINDER GmbH .....	67
<b>22. DISPOSAL .....</b>	<b>67</b>
22.1 Disposal of the transport packing .....	67
22.2 Decommissioning .....	67
22.3 Disposal of the chamber in the Federal Republic of Germany .....	68
22.4 Disposal of the chamber in the member states of the EU except for the Federal Republic of Germany .....	69
22.5 Disposal of the chamber in non-member states of the EU .....	70
<b>23. TECHNICAL DESCRIPTION .....</b>	<b>70</b>
23.1 Factory calibration and adjustment .....	70
23.2 Definition of usable volume .....	70
23.3 Over current protection .....	71
23.4 FP technical data .....	71
23.5 Equipment and options (extract) .....	73
23.6 Accessories and spare parts (extract) .....	74
23.7 Dimensions size 56 .....	75
23.8 Dimensions size 115 .....	76
23.9 Dimensions size 260 .....	77
23.10 Dimensions size 720 .....	78
<b>24. CERTIFICATES AND DECLARATIONS OF CONFORMITY .....</b>	<b>79</b>
24.1 EU Declaration of Conformity .....	79
24.2 UKCA Declaration of Conformity .....	82
24.3 Certificate for the GS mark of conformity of the “Deutsche Gesetzliche Unfallversicherung e.V.” (German Social Accident Insurance) DGUV .....	83
<b>25. CONTAMINATION CLEARANCE CERTIFICATE .....</b>	<b>85</b>
25.1 For chambers located outside the USA and Canada .....	85
25.2 For chambers located in the USA and Canada .....	88

Dear customer,

For the correct operation of the chambers, it is important that you read this operating manual completely and carefully and observe all instructions as indicated. Failure to read, understand and follow the instructions may result in personal injury. It can also lead to damage to the chamber and/or poor equipment performance

## 1. Safety

### 1.1 Personnel Qualification



The chamber must only be installed, tested, and started up by personnel qualified for assembly, startup, and operation of the chamber. Qualified personnel are persons whose professional education, knowledge, experience and knowledge of relevant standards allow them to assess, carry out, and identify any potential hazards in the work assigned to them. They must have been trained and instructed, and be authorized, to work on the chamber.

The chamber should only be operated by laboratory personnel especially trained for this purpose and familiar with all precautionary measures required for working in a laboratory. Observe the national regulations on minimum age of laboratory personnel.

### 1.2 Operating manual

This operating manual is part of the components of delivery. Always keep it handy for reference in the vicinity of the chamber. If selling the unit, hand over the operating manual to the purchaser.

To avoid injuries and damage observe the safety instructions of the operating manual. Failure to follow instructions and safety precautions can lead to significant risks.

	 <b>DANGER</b>
<p><b>Dangers due to failure to observe the instructions and safety precautions. Serious injuries and chamber damage. Risk of death.</b></p> <ul style="list-style-type: none"> <li>➤ Observe the safety instructions in this Operating Manual.</li> <li>➤ Follow the operating procedures in this Operating Manual.</li> <li>➤ Carefully read the complete operating instructions of the chamber prior to installing and using the chamber.</li> <li>➤ Keep the operating manual for future reference</li> </ul>	

	<p>Make sure that all persons who use the chamber and its associated work equipment have read and understood the Operating Manual.</p>
---	--

This Operating Manual is supplemented and updated as needed. Always use the most recent version of the Operating Manual. When in doubt, call the BINDER Service Hotline for information on the up-to-date-ness and validity of this Operating Manual.

### 1.3 Legal considerations

This operating manual is for informational purposes only. It contains information for correct and safe installing, start-up, operation, decommissioning, cleaning and maintenance of the product. Note: the contents and the product described are subject to change without notice.

Understanding and observing the instructions in this operating manual are prerequisites for hazard-free use and safety during operation and maintenance. Images are to provide basic understanding. They may deviate from the actual version of the chamber. The actual scope of delivery can, due to optional or special design, or due to recent technical changes, deviate from the information and illustrations in these instructions this operating manual. In no event shall BINDER be held liable for any damages, direct or incidental arising out of or related to the use of this manual.

This operating manual cannot cover all conceivable applications. If you would like additional information, or if special problems arise that are not sufficiently addressed in this manual, please ask your dealer or contact us directly, e.g. by phone at the number located on page one of this manual

Furthermore, we emphasize that the contents of this operating manual are not part of an earlier or existing agreement, description, or legal relationship, nor do they modify such a relationship. All obligations on the part of BINDER derive from the respective purchase contract, which also contains the entire and exclusively valid statement of warranty administration and the general terms and conditions, as well as the legal regulations valid at the time the contract is concluded. The statements in this manual neither augment nor restrict the contractual warranty provisions.

### 1.3.1 Intellectual property

**This operating manual is protected by copyright. Any unauthorized copying or disclosure to third parties is strictly prohibited. We reserve the right to take legal action and, if necessary, to assert claims for damages in the event of infringement.**

**Trademark Information:** All BINDER trademarks relating to products or service, as well as trade names, logos and product names used on the website, products and documents of BINDER company are trademarks or registered trademarks of BINDER company (including BINDER GmbH, BINDER Inc.) in the U.S. and other countries and communities of states. This includes word marks, position marks, word/figurative marks, design configurations, figurative marks, and design patents.

**Patent Information:** BINDER products, categories of products, and accessories may be covered by one or more patents and/or utility models in the U.S. and other countries and communities of states. This information is provided to satisfy the virtual patent marking provisions of various jurisdictions, in particular it is intended to serve as notice under 35 U.S.C. § 287(a). Products and services listed on the BINDER website may be sold individually or as part of a combination product. Additional patent applications may also be pending in the U.S. and other countries and communities of states.

Please visit [www.binder-world.com](http://www.binder-world.com) for more information.

## 1.4 Structure of the safety instructions

In this operating manual, the following safety definitions and symbols indicate dangerous situations following the harmonization of ISO 3864-2 and ANSI Z535.6.

### 1.4.1 Signal word panel

Depending on the probability of serious consequences, potential dangers are identified with a signal word, the corresponding safety color, and if appropriate, the safety alert symbol.

 <b>DANGER</b>
Indicates an imminently hazardous situation that, if not avoided, will result in death or serious (irreversible) injury.

 <b>WARNING</b>
Indicates a potentially hazardous situation which, if not avoided, could result in death or serious (irreversible) injury

 <b>CAUTION</b>
Indicates a potentially hazardous situation which, if not avoided, may result in moderate or minor (reversible) injury

## NOTICE

Indicates a potentially hazardous situation which, if not avoided, may result in damage to the product and/or its functions or of a property in its proximity.

### 1.4.2 Safety alert symbol



Use of the safety alert symbol indicates a **risk of injury**.

Observe all measures that are marked with the safety alert symbol in order to avoid death or injury.

### 1.4.3 Pictograms

Warning signs			
Electrical hazard	Hot surface	Explosive atmosphere	Stability hazard
Lifting hazard	Risk of corrosion and / or chemical burns	Suffocation hazard	Harmful substances
Biohazard	Pollution Hazard		
Mandatory action signs			
Mandatory regulation	Read operating instructions	Disconnect the power plug	Lift with several persons
Lift with mechanical assistance	Environment protection	Wear protective gloves	Wear safety goggles
Prohibition signs			
Do NOT touch	Do NOT spray with water		



**Information** to be observed in order to ensure optimum function of the product.

### 1.4.4 Word message panel structure

**Type / cause of hazard.**



**Possible consequences.**

- ⊘ Instruction how to avoid the hazard: prohibition.
- Instruction how to avoid the hazard: mandatory action.

Observe all other notes and information not necessarily emphasized in the same way, in order to avoid disruptions that could result in direct or indirect injury or property damage.

### 1.5 Localization / position of safety labels on the chamber

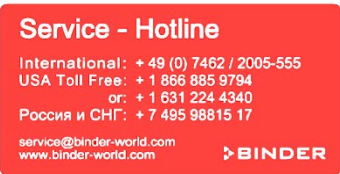
The following labels are located on the chamber:

Pictograms (Warning signs)	Service label
 <p>Hot surface</p> <ul style="list-style-type: none"> <li>• Outer chamber door</li> <li>• On chamber rear next to the exhaust duct</li> </ul>	
 <p>Read operating manual</p> <ul style="list-style-type: none"> <li>• UL chamber: outer chamber door</li> </ul>	

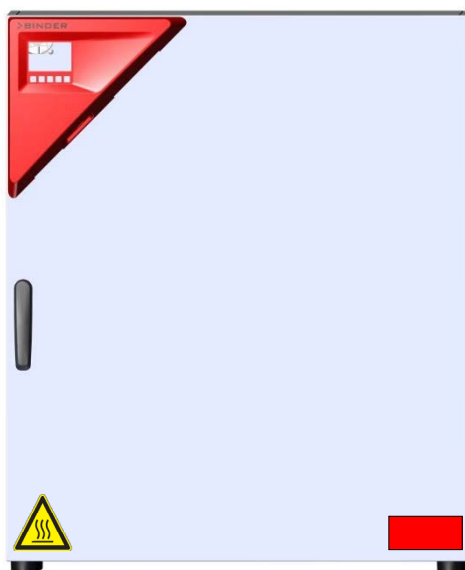

Figure 1: Position of labels on the chamber front (example: FP 56)



Keep safety labels complete and legible.

Replace safety labels that are no longer legible. Contact BINDER Service for these replacements.



## 1.6 Type plate

The type plate is located on the left-hand side of the chamber, bottom right-hand.



Figure 2: Type plate (example FP 115 regular chamber)

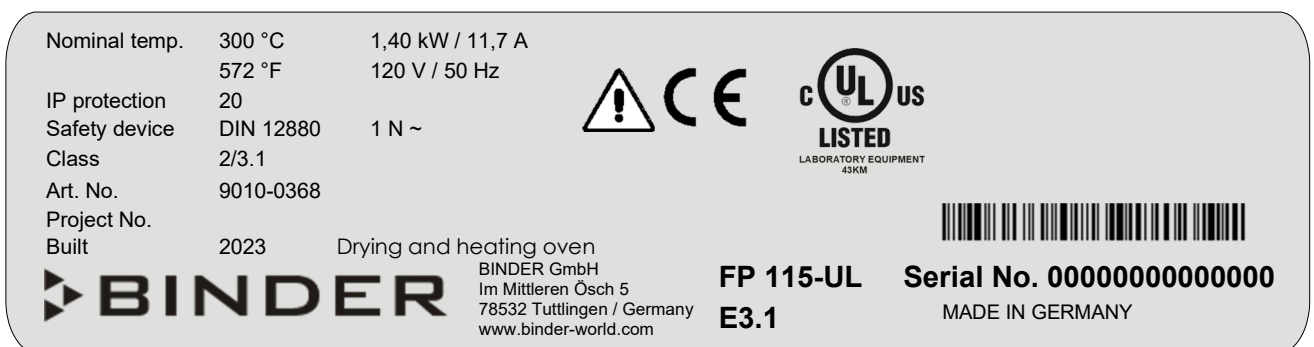

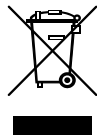





Figure 3: Type plate (example FP-UL 115regular chamber)

### Indications of the type plate (example)

Indication		Information
BINDER		Manufacturer: BINDER GmbH
FP 115		Model designation
Drying and heating oven		Chamber name: Drying and heating oven
Serial No.	000000000000	Serial No of the chamber
Built	2023	Year of construction
Nominal temperature	300 °C 572 °F	Nominal temperature
IP protection	20	IP type of protection acc. to EN 60529
Temp. safety device	DIN 12880	Temperature safety device acc. to standard DIN 12880
Class	2/3.1	Class of temperature safety device (selectable)
Art. No.	9010-0364	Art. no. of the chamber
Project No.	---	Optional: Special application acc. to project no.
1,40 kW		Nominal power
6,10 A		Nominal current
230 V / 50 Hz		Nominal voltage ± 10% at the indicated power frequency
230 V / 60 Hz		
1 N ~		Current type

### Symbols on the type plate

Symbol	Valid for	Information
	All chambers	CE conformity marking
	All chambers except chambers	Electrical and electronic equipment manufactured / placed on the market in the EU after 13 August 2005 and be disposed of in separate collection according to Directive 2012/19/EU on waste electrical and electronic equipment (WEEE).
	Not for UL chambers	GS mark of conformity of the "Deutsche Gesetzliche Unfallversicherung e.V. (DGUV), Prüf- und Zertifizierungsstelle Nahrungsmittel und Verpackung im DGUV Test" (German Social Accident Insurance (DGUV), Testing and Certification Body for Foodstuffs and Packaging Industry in DGUV Test).
	UL chambers only	The chamber is certified by Underwriters Laboratories Inc.® according to the following standards: <ul style="list-style-type: none"> <li>• ANSI/UL/IEC EN 61010-1 Edition 3, 2012-05, with revisions through July 19, 2019 evaluation</li> <li>• CSA-C22.2 No. 61010-1-12 Edition 3, 2012-05, with revisions through 2018-11 evaluation</li> </ul>
	UL chambers only	Read operating manual.

### 1.7 UKCA Label

The sticker with UKCA Authorised Representative details sticks next to the type plate to the left side of the chamber, bottom right-hand.



Figure 4: UKCA Label

### Symbol on the sticker

Symbol	Applies to	Information
	All models except UL models	UKCA conformity marking

### 1.8 General safety instructions on installing and operating the chambers



With regard to operating the chambers and to the installation location, please observe the local and national regulations relevant for your country (for Germany: DGUV guidelines 213-850 on safe working in laboratories, issued by the employers' liability insurance association).

BINDER GmbH is only responsible for the safety features of the chamber provided skilled electricians or qualified personnel authorized by BINDER perform all maintenance and repair, and if components relating to chamber safety are replaced in the event of failure with original spare parts.



To operate the chamber, use only original BINDER accessories or accessories from third-party suppliers authorized by BINDER. The user is responsible for any risk caused by using unauthorized accessories.

	NOTICE
	<p><b>Danger of overheating due to lack of ventilation.</b>  <b>Damage to the chamber.</b></p> <ul style="list-style-type: none"> <li>⊘ Do NOT install the chamber in unventilated recesses.</li> <li>➤ Ensure sufficient ventilation for dispersal of the heat.</li> <li>➤ Observe the prescribed minimum distances when installing the chamber (chap. 3.4)</li> </ul>

Do not install or operate the chambers in hazardous locations.



	 <b>DANGER</b>
	<p><b>Danger of explosion due to combustible dusts or explosive mixtures in the vicinity of the chamber.</b>  <b>Serious injury or death from burns and / or explosion pressure.</b></p> <ul style="list-style-type: none"> <li>⊘ Do NOT operate the chamber in potentially explosive areas.</li> <li>➤ KEEP combustible dust or air-solvent mixtures AWAY from the chamber.</li> </ul>

The chambers do not dispose of any measures of explosion protection.

	 <b>DANGER</b>
	<p><b>Danger of explosion due to introduction of flammable or explosive substances in the chamber.</b>  <b>Serious injury or death from burns and / or explosion pressure.</b></p> <ul style="list-style-type: none"> <li>⊘ Do NOT introduce any substance into the chamber which is combustible or explosive at working temperature.</li> <li>⊘ Do NOT introduce any combustible dust or air-solvent mixture in the inner chamber.</li> </ul>



Any solvent contained in the charging material must not be explosive or inflammable. I.e., irrespective of the solvent concentration in the steam room, NO explosive mixture with air must form. The temperature inside the chamber must lie below the flash point or below the sublimation point of the charging material. Familiarize yourself with the physical and chemical properties of the charging material, as well as the contained moisture constituent and its behavior with the addition of heat energy.

Familiarize yourself with any potential health risks caused by the charging material, the contained moisture constituent or by reaction products that may arise during the temperature process. Take adequate measures to exclude such risks prior to putting the chamber into operation.

	 <b>DANGER</b>
	<p><b>Electrical hazard by water entering the chamber.</b>  <b>Deadly electric shock.</b></p> <ul style="list-style-type: none"> <li>⊘ The chamber must NOT become wet during operation, cleaning, or maintenance.</li> <li>⊘ Do NOT install the chamber in damp areas or in puddles.</li> <li>➤ Set up the chamber in a splash-proof manner.</li> </ul>

The chambers were produced in accordance with VDE regulations and were routinely tested in accordance to VDE 0411-1 (IEC 61010-1).

During and shortly after operation, the temperature of the inner surfaces almost equals the set-point. The inner chamber, exhaust duct, the door gaskets, and the area of the access ports (option), will become hot during operation.

	 <b>CAUTION</b>
	<p><b>Danger of burning by touching hot chamber parts during or after operation.</b>  <b>Burns.</b></p> <ul style="list-style-type: none"> <li>Ø Do NOT touch the inner surfaces, exhaust duct, access ports (option), door gaskets, or the charging material during operation.</li> <li>Ø Do NOT place the power cable over the door gap when the chamber is hot after operation.</li> </ul>

## 1.9 Intended use

	<p>Observing the instructions in this operating manual and conducting regular maintenance work (chap. 21.2) is part of the intended use.</p>
---	--

**Any use of the chambers that does not comply with the requirements specified in this Operating Manual shall be considered improper use.**

**Other applications than those described in this chapter are not approved.**

### Use

The chambers are suitable for exact tempering of harmless materials and for drying and heat treatment of solid or pulverized charging material, as well as bulk material, using the supply of heat. They can be used to dry e.g. glassware, and for warm storage of liquids in containers.



DO NOT use the device for drying processes that release so large amounts of water vapor that condensation occurs.

### Requirements for the chamber load



Any solvent must not be explosive or flammable. A mixture of any component of the charging material with air must NOT be explosive. The operating temperature must lie below the flash point or below the sublimation point of the charging material. Any component of the charging material must NOT be able to release toxic gases.

The loading material shall not contain any corrosive ingredients that may damage the machine components made of stainless steel, aluminum, and copper. Such ingredients include in particular acids and halides. Any corrosive damage caused by such ingredients is excluded from liability by BINDER GmbH.

The chamber does not dispose of any measures of explosion protection.

 	 <b>DANGER</b>
	<p><b>Explosion or implosion hazard and danger of poisoning through the introduction of unsuitable loading material.</b></p> <p><b>Poisoning. Serious injury or death from burns and / or explosion pressure.</b></p> <ul style="list-style-type: none"> <li>Ø Do NOT introduce any substance combustible or explosive at working temperature into the chamber, in particular no energy sources such as batteries or lithium-ion batteries.</li> <li>Ø NO explosive dust or air-solvent mixture in the inner chamber.</li> <li>Ø Do NOT introduce any substance which could lead to release of toxic gases.</li> </ul>

Contamination of the chamber by toxic, infectious or radioactive substances must be prevented

	<b>WARNING</b>
 	<p><b>Danger of intoxication and infection through contamination of the chamber with toxic, infectious or radioactive substances.</b></p> <p><b>Damages to health.</b></p> <ul style="list-style-type: none"> <li>➤ Protect the interior of the chamber from contamination by toxic, infectious or radioactive substances.</li> <li>➤ Take suitable protective measures when introducing and removing toxic, infectious or radioactive material</li> </ul>

In case of foreseeable use of the chamber there is no risk for the user through the integration of the chamber into systems or by special environmental or operating conditions in the sense of EN 61010-1:2010. For this, the intended use of the chamber and all its connections must be observed.

Connect only external devices to the chamber interfaces Ethernet and USB which are compliant with the standards EN 61010-1:2010 or EN 60950-1:2006 mod.

### Medical devices

The chambers are not classified as medical devices as defined by Regulation (EU) No 2017/745.

	<p>Due to the special demands of the Medical Products legislation, these chambers are not qualified to perform sterilization of medical devices as defined by Regulation (EU) No 2017/745.</p>
---	--

### Personnel Requirements

Only trained personnel with knowledge of the Operating Manual can set up and install the chamber, start it up, operate, clean, and take it out of operation. Service and repairs call for further technical requirements (e.g. electrical know-how), as well as knowledge of the service manual.

### Installation site requirements

The chambers are designed for setting up inside a building (indoor use).

The requirements described in the Operating Manual for installation site and ambient conditions (chap. 3.4) must be met.

	<p><b>WARNING:</b> If customer should use a BINDER chamber running in non-supervised continuous operation, we strongly recommend in case of inclusion of irrecoverable specimen or samples to split such specimen or samples and store them in at least two chambers, if this is feasible.</p>
---	--

## 1.10 Foreseeable Misuse

Other applications than those described in chap. 1.9 are not approved.

This expressly includes the following misuses (the list is not exhaustive), which pose risks despite the inherently safe construction and existing technical safety equipment:

- Non-observance of Operating Manual
- Non-observance of information and warnings on the chamber (e.g. control unit messages, safety identifiers, warning signals)
- Installation, startup, operation, maintenance and repair by untrained, insufficiently qualified, or unauthorized personnel
- Missed or delayed maintenance and testing
- Non-observance of traces of wear and tear
- Insertion of materials excluded or not permitted by this Operating Manual.

- Non-compliance with the admissible parameters for processing the respective material.
- Installation, testing, service or repair in the presence of solvents
- Installation of replacement parts and use of accessories and operating resources not specified and authorized by the manufacturer
- Installation, startup, operation, maintenance or repair of the chamber in absence of operating instructions
- Bypassing or changing protective systems, operation of the chamber without the designated protective systems
- Non-observance of messages regarding cleaning and disinfection of the chamber.
- Spilling water or cleaning agent on the chamber, water penetrating into the chamber during operation, cleaning or maintenance
- Cleaning activity while the chamber is turned on
- Operation of the chamber with a damaged housing or damaged power cord
- Continued operation of the chamber during an obvious malfunction
- Insertion of objects, particularly metallic objects, in louvers or other openings or slots on the chamber
- Human error (e.g. insufficient experience, qualification, stress, exhaustion, laziness)

To prevent these and other risks from incorrect operation, the operator shall issue operating instructions. Standard operating procedures (SOPs) are recommended.

## 1.11 Residual Risks

The unavoidable design features of a chamber, as well as its proper field of application, can also pose risks, even during correct operation. These residual risks include hazards which, despite the inherently safe design, existing technical protective equipment, safety precautions and supplementary protective measures, cannot be ruled out.

Messages on the chamber and in the Operating Manual warn of residual risks. The consequences of these residual risks and the measures required to prevent them are listed in the Operating Manual. Moreover, the operator must take measures to minimize hazards from unavoidable residual risks. This includes, in particular, issuing operating instructions.

The following list summarizes the hazards against which this Operating Manual and the Service Manual warn, and specifies protective measures at the appropriate spots:

### Unpacking, Transport, Installation

- Sliding or tilting the chamber
- Setup of the chamber in unauthorized areas
- Installation of a damaged chamber
- Installation of a chamber with damaged power cord
- Inappropriate site of installation
- Missing protective conductor connection

### Normal operation

- Assembly errors
- Contact with hot surfaces on the housing
- Contact with hot surfaces in the interior and inside of doors
- Emission of non-ionizing radiation from electrical operating resources
- Contact with live parts in normal state
- Inappropriate handling of inert gas (option)

### **Cleaning and Decontamination**

- Penetration of water into the chamber
- Inappropriate cleaning and decontamination agents
- Enclosure of persons in the interior

### **Malfunction and Damage**

- Continued operation of the chamber during an obvious malfunction or outage of the heating system
- Contact with live parts during error status
- Operation of a unit with damaged power cord

### **Maintenance**

- Maintenance work on live parts.
- Execution of maintenance work by untrained/insufficiently qualified personnel
- Electrical safety analysis during annual maintenance not performed

### **Trouble-shooting and Repairs**

- Non-observance of warning messages in the Service Manual
- Trouble-shooting of live parts without specified safety measures
- Absence of a plausibility check to rule out erroneous inscription of electrical components
- Performance of repair work by untrained/insufficiently qualified personnel
- Inappropriate repairs which do not meet the quality standard specified by BINDER
- Use of replacement parts other than BINDER original replacement parts
- Electrical safety analysis not performed after repairs

## **1.12 Operating instructions**

Depending on the application and location of the chamber, the operator of the chamber must provide the relevant information for safe operation of the chamber in a set of operating instructions.



Keep these operating instructions with the chamber at all times in a place where they are clearly visible. They must be comprehensible and written in the language of the employees.

## **1.13 Measures to prevent accidents**

The operator of the chamber must observe the local and national regulations (for Germany: the rule "Operation of work equipment. Operation of refrigeration systems, heat pumps and refrigeration equipment", GUV-R 500 chap. 2.35) and take precautions to prevent accidents.

The manufacturer took the following measures to prevent ignition and explosions:

- **Indications on the type plate**

See operating manual chap. 1.6.

- **Operating manual**

An operating manual is available for each chamber.

- **Overtemperature monitoring**

The chamber is equipped with a temperature display, which can be read from outside.

The chamber is equipped with an additional safety controller (temperature safety device class 2 or 3.1 (adjustable) acc. to DIN 12880:2007). Visual and audible (buzzer) signals indicate temperature exceeding.

- **Safety, measurement, and control equipment**

The safety, measuring, and control equipment is easily accessible.

- **Electrostatic charge**

The interior parts are grounded.

- **Non-ionizing radiation**

Non-ionizing radiation is not intentionally produced, but released only for technical reasons by electrical equipment (e.g. electric motors, power cables, solenoids). The machine has no permanent magnets. If persons with active implants (e.g. pacemakers, defibrillators) keep a safe distance (distance of field source to implant) of 30 cm, an influence of these implants can be excluded with high probability.

- **Protection against touchable surfaces**

Tested according to EN ISO 13732-1:2008.

- **Floors**

See operating manual chap. 3.4 for correct installation

- **Cleaning**

See operating manual chap. 21.4.

- **Examinations**

The chamber has been inspected by the "Deutsche Gesetzliche Unfallversicherung e.V. (DGUV) (German Social Accident Insurance (DGUV))" (German Social Accident Insurance (DGUV), Testing and Certification Body for Foodstuffs and Packaging Industry in DGUV Test) and bears the GS mark. (Not valid for UL chambers)

UL chambers only: The chamber is certified by Underwriters Laboratories Inc.® according to the standards UL 61010-1, 3<sup>rd</sup> Edition, 2012-05, Rev. 2015-07; CAN/CSA-C22.2 No. 61010-1, 3<sup>rd</sup> Edition, 2012-05, Rev. 2015-07; IEC/EN 61010-1:2014, 3<sup>rd</sup> Edition.



## 2. Chamber description

BINDER drying and heating ovens FP are equipped with an Mikroprozessor-Bildschirmregler für Temperatur und Lüfterdrehzahl, which indicates the temperature with an accuracy of a tenth of a degree.

All chambers are heated electrically and ventilated by fan-assisted, forced-air circulation.

The concept of air conduction guarantees high level of spatial and time-based temperature precision, thanks to the direct and distributed air circulation into the interior. The fan supports exact attainment and maintenance of the desired temperature accuracy.

The chambers are regularly equipped with an overtemperature safety device class 1 acc. to DIN12880:2007 and with an overtemperature safety controller (selectable between overtemperature temperature safety device class 2 or class 3.1 acc. to DIN12880:2007), see chap. 11).

The chambers are equipped with the "FailSafe" function, a second temperature sensor is used for mutual monitoring and takes over the function in the event of an error (chap. 10).

**Material:** The inner chamber and the inside of the doors are made of stainless steel V2A (German material no. 1.4301, US equivalent AISI 304 and material no. 1.4016, US equivalent AISI 430). When operating the chambers at temperatures above 150 °C / 302 °F, the impact of the oxygen in the air may cause discoloration of the metallic surfaces (yellowish-brown or blue) by natural oxidation processes. These colorations are harmless and will in no way impair the function or quality of the chamber. The housing is RAL 7035 powder-coated. All corners and edges are also completely coated.

All chamber functions are easy and comfortable to use thanks to their clear arrangement. Major features are easy cleaning of all chamber parts and avoidance of undesired contamination.

The chambers sizes 56, 115, 260 are equipped with an on/off switch on the bottom right-hand side of the door. The chamber size 720 has a main power switch on the chamber rear.

The chambers are regularly equipped with a zero-voltage relay alarm contact and two zero-voltage switching contacts. As optional equipment they are available with analog output, access ports with silicone plugs, HEPA air filter, inert gas connection with mostly gas-tight design.

The chambers are regularly equipped with an Ethernet interface for computer communication, e.g. via the APT-COM™ 4 Multi Management Software (option, chap. 19.1) and with a USB interface to read out the measured values in real time.

The models size 720 are equipped with four castors. Both front castors can be locked by brakes.

Temperature ranges see technical data (chap. 23.4).

## 2.1 Chamber overview

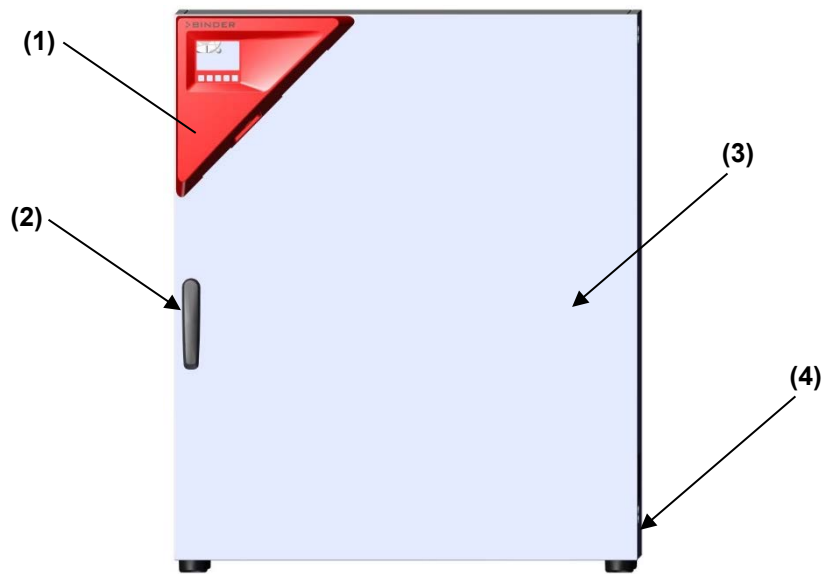

Figure 5: Overview, closed chamber with single door



Figure 6: Overview, open chamber with single door

- (1) Triangular instrument panel with controller RD4 and USB interface
- (2) Door handle
- (3) Outer door
- (4) On/Off switch (up to size 260)
- (5) Rack

## 2.2 Chamber rear

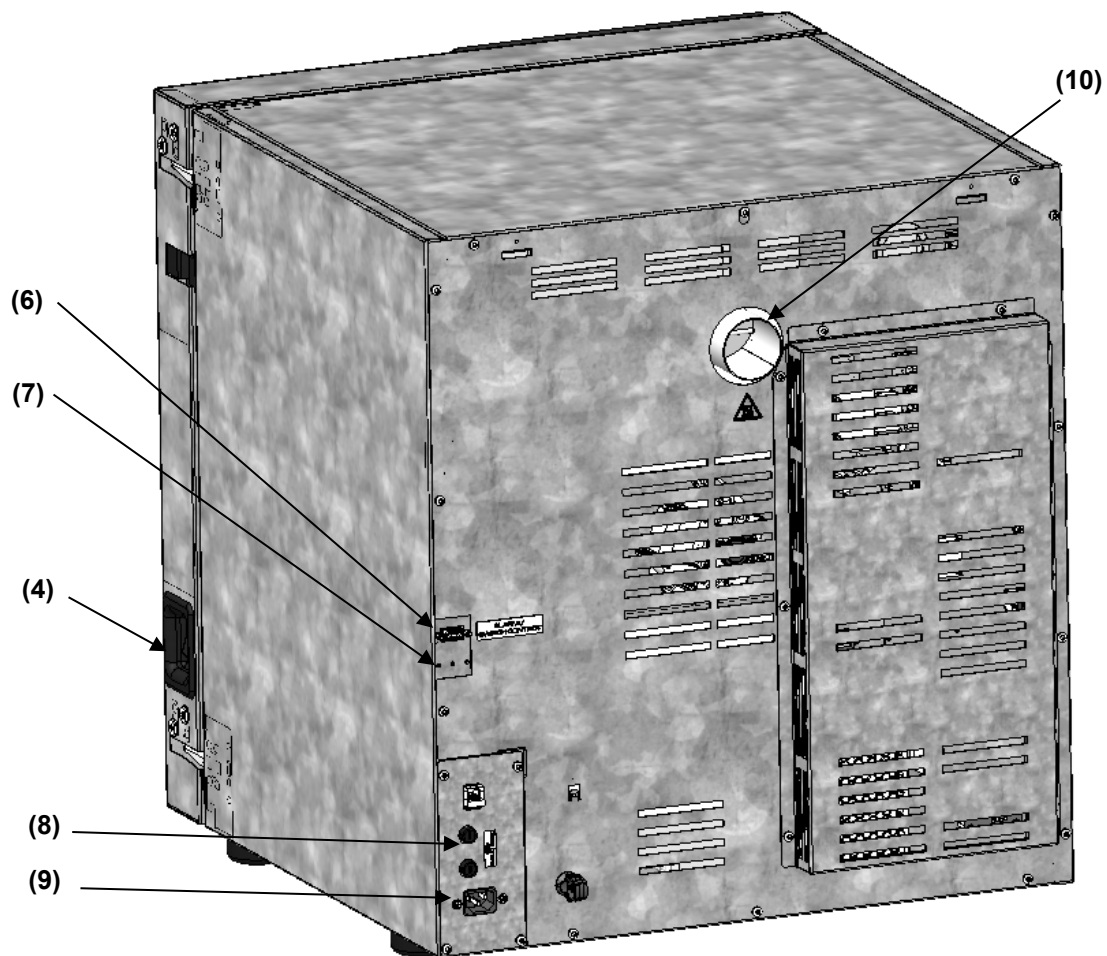

Figure 7: Overview, chamber with single door

- (4) On/Off switch (up to size 260)
- (6) SUB-D socket "ALARM / SWITCH CONTACT" for zero-voltage relay alarm contact and two zero-voltage switching contacts
- (7) SUB-D socket "ANALOG OUTPUT" (option) for optional analog output
- (8) Miniature fuses 250 V AC (T) (up to size 260):  
2x 6,3 A for FP 56 und 115, 2x 8 A for FP 260, 2x 12,5 A for FP-UL
- (9) Connection for IEC connector plug (up to size 260) 230 V AC for FP / 100-120 V AC for FP-UL
- (10) Exhaust duct

## 2.3 Triangular instrument panel

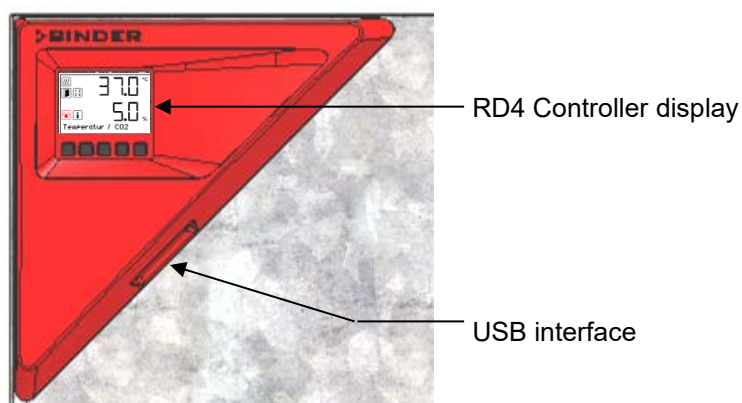

Figure 8: Triangular instrument panel with RD4 chamber controller and USB interface

## 2.4 Main power switch on the chamber rear (size 720)

The chambers size 720 are equipped with a main power (11) switch located on the chamber rear.

The rear power switch allows completely switching off the chamber (de-energized condition). The switch is intended for service and is intended to be used as a power disconnection device in the event of danger.



Figure 9: Main power switch (11) on the chamber rear

## 2.5 Zero-voltage switching contacts

The chambers are regularly equipped with two zero-voltage switching contacts.

The SUB-D socket "ALARM / SWITCH CONTACT" (6) serves not only for collective alarm output via zero-voltage alarm contact (chap. 14.4) but also for controlling two switching contacts via the program controller, which serve to switch any device connected to the zero-voltage relay output. They are controlled in the "Functions on/off" menu of the chamber controller (chap. 8).

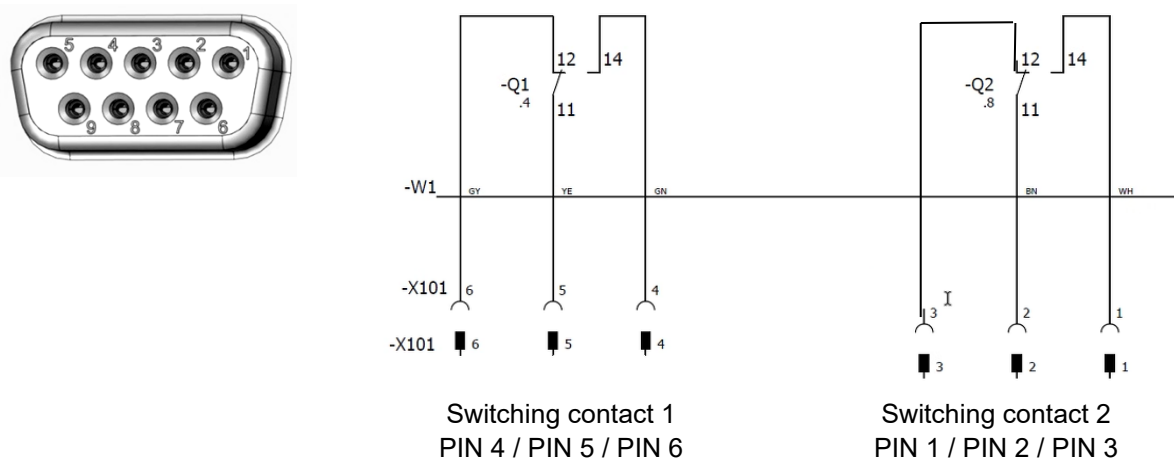



Figure 10: Pin allocation of the SUB-D socket „ALARM / SWITCH CONTACT“ (6) for zero-voltage switching contacts

Maximum loading capacity of the switching contacts: 24V AC/DC – 2.5 A

	 <b>DANGER</b>
	<p><b>Electrical hazard through overload of contacts.</b>  <b>Deadly electric shock. Damage to the switching contacts and connection socket.</b></p> <ul style="list-style-type: none"> <li>Ø Do NOT exceed the maximum switching load of 24V AC/DC – 2.5A.</li> <li>Ø Do NOT connect any devices with a higher loading capacity.</li> </ul>





### 3. Completeness of delivery, transportation, storage, and installation

#### 3.1 Unpacking, and checking equipment and completeness of delivery

After unpacking, please check the chamber and its optional accessories, if any, based on the delivery receipt for completeness and for transportation damage. Inform the carrier immediately if transportation damage has occurred.

The final tests of the manufacturer may have caused traces of the racks on the inner surfaces. This has no impact on the function and performance of the chamber.

Please remove any transportation protection devices and adhesives in/on the chamber and on the doors and take out the operating manuals and accessory equipment.

   	 <b>CAUTION</b>
	<p><b>Risk of injury and damages by lifting heavy loads and by sliding or tilting of the chamber due to improper lifting.</b>  <b>Injuries, damage to the chamber.</b></p> <ul style="list-style-type: none"> <li>Ø Do NOT lift or transport the chamber using the door handle or the door.</li> <li>Ø Do NOT lift chambers size 720 by hand</li> <li>➤ Lift the chamber size 56 and 115 from the pallet at its four lower corners with the aid of 2 people, chamber size 260 with the aid of 4 people.</li> <li>➤ Lift chambers size 720 from the pallet using technical devices (fork lifter). Set the fork lifter only from the rear in the middle of the chamber. Make sure to place all the lateral supports of the chamber on the forks.</li> </ul>

If you need to return the chamber, please use the original packing and observe the guidelines for safe lifting and transportation (chap. 3.2).

For disposal of the transport packing, see chap. 22.1.



#### Note on second-hand chambers (Ex-Demo-Units):

Second-hand chambers are chambers that have been used for a short time for tests or exhibitions. They are thoroughly tested before resale. BINDER ensures that the chamber is technically sound and will work flawlessly.

Second-hand chambers are marked with a sticker on the chamber door. Please remove the sticker before commissioning the chamber.

### 3.2 Guidelines for safe lifting and transportation

The front castors of chambers size 720 can be blocked by brakes. Please move the chambers with castors only when empty and on an even surface, otherwise the castors may be damaged. After operation, please observe the guidelines for temporarily decommissioning the chamber (chap. 22.2).

	 <b>CAUTION</b>
<p><b>Risk of injury and damages by lifting heavy loads and by sliding or tilting of the chamber due to improper transportation.</b></p> <p><b>Injuries, damage to the chamber.</b></p> <ul style="list-style-type: none"> <li>➤ Transport the chamber only in its original packaging.</li> <li>➤ Secure the chamber with transport straps for transport.</li> <li>⊘ Do NOT lift or transport the chamber using the door handle or the door.</li> <li>⊘ Do NOT lift chambers size 720 by hand</li> <li>➤ Lift chamber size 56 and 115 at its four lower corners with the aid of 2 people, chamber size 260 with the aid of 4 people, and place it on a transport pallet with wheels. Push the pallet to the desired site and then lift the chamber from the pallet at its four lower corners.</li> <li>➤ Place chamber size 720 using technical devices (fork lifter) on the transport pallet. Set the fork lifter only from the rear in the middle of the chamber. Make sure to place all the lateral supports of the chamber on the forks.</li> <li>➤ Transport chamber size 720 ONLY with the original transport pallet. Without the pallet the chamber is in imminent danger of overturning!</li> </ul>	

- Permissible ambient temperature range during transport: -10 °C to +60 °C / 14 °F to 140 °F.

You can order transport packing and pallets for transportation purposes from BINDER Service.

### 3.3 Storage

Intermediate storage of the chamber is possible in a closed and dry room. Observe the guidelines for temporary decommissioning (chap. 22.2).

- Permissible ambient temperature range during storage: -10 °C to +60 °C / 14 °F to 140 °F.
- Permissible ambient humidity: max. 70 % r.H., non-condensing



When after storage in a cold location you transfer the chamber to its warmer installation site, condensation may form. Before start-up, wait at least one hour until the chamber has attained ambient temperature and is completely dry.

### 3.4 Location of installation and ambient conditions

Set up the chamber on an even and non-flammable surface, free from vibration and in a well-ventilated, dry location and align it using a spirit level. The site of installation must be capable of supporting the chamber's weight (see technical data, chap. 23.4). The chambers are designed for setting up inside a building (indoor use).

	<b>NOTICE</b>
<p><b>Danger of overheating due to lack of ventilation.</b></p> <p><b>Damage to the chamber.</b></p> <ul style="list-style-type: none"> <li>⊘ Do NOT install the chamber in unventilated recesses.</li> <li>➤ Ensure sufficient ventilation for dispersal of the heat.</li> <li>➤ Observe the prescribed minimum distances when installing the chamber.</li> </ul>	

Do not install or operate the chamber in potentially explosive areas.

	 <b>DANGER</b>
	<p><b>Danger of explosion due to combustible dusts or explosive mixtures in the vicinity of the chamber.</b></p> <p><b>Serious injury or death from burns and / or explosion pressure.</b></p> <ul style="list-style-type: none"> <li>⊘ Do NOT operate the chamber in potentially explosive areas.</li> <li>➤ KEEP explosive dust or air-solvent mixtures AWAY from the vicinity of the chamber.</li> </ul>

### Ambient conditions

- Permissible ambient temperature range during operation: +18 °C up to +40 °C / 64.4 °F to 104 °F. At elevated ambient temperature values, fluctuations in temperature can occur.

	<p>The ambient temperature should not be substantially higher than the indicated ambient temperature of +22 °C +/- 3 °C / 77 °F to which the specified technical data relate. For other ambient conditions, deviations from the indicated data are possible.</p>
---	--

- Permissible ambient humidity: 70 % r.H. max., non-condensing.
- Installation height: max. 2000 m / 6562 ft. above sea level.

### Minimum distances

When placing several chambers of the same size side by side, maintain a minimum distance of 250 mm / 9.84 in between each chamber. Wall distances: rear 160 mm / 6.30 in, sides 100 mm / 3.94 in. Spacing above the chamber of at least 100 mm / 3.94 in must also be accounted for.

- When placing several chambers of the same size side by side, maintain a minimum distance of 250 mm / 9.84 in between each chamber.
- Wall distances: rear 160 mm / 6.30 in, sides 100 mm / 3.94 in.
- Spacing above the chamber of at least 100 mm / 3.9 in must also be accounted for.

### Stacking

Two devices up to size 115 can be stacked on top of each other. For this purpose place rubber pads Art. no. 8012-0001 under all feet of the upper chamber to prevent the device from slipping.

	<b>NOTICE</b>
	<p><b>Risk of damages by sliding or tilting of the upper chamber.</b></p> <p><b>Damage to the chambers.</b></p> <ul style="list-style-type: none"> <li>➤ When stacking, place rubber pads under all feet of the upper chamber.</li> <li>➤ Stack only chambers of the same size.</li> </ul>

Chambers sizes 260 and 720 must NOT be stacked.

	<b>NOTICE</b>
	<p><b>Danger by stacking.</b></p> <p><b>Damage to the chambers.</b></p> <ul style="list-style-type: none"> <li>⊘ Do NOT place chambers sizes 260 or 720 on top of each other.</li> </ul>

### Other requirements

To completely separate the chamber from the power supply, you must disconnect the power plug. Install the chamber in a way that the power plug is easily accessible and can be easily pulled in case of danger. Do not conduct the power cable above the exhaust duct.



## 4. Installation



### 4.1 Electrical connection

The chambers are supplied ready for connection.

The chambers FP 720 and FP 720-UL come with a fixed power connection cable of at least 1800 mm / 70.87 in in length. The other chambers come with an IEC connector plug.

Model	Power plug / power cable	Nominal voltage +/- 10% at the indicated power frequency	Current type	Chamber fuse
FP 56	Grounded plug	230 V at 50 Hz 230 V at 60 Hz	1N~	6,3 A
FP 115	Grounded plug	230 V at 50 Hz 230 V at 60 Hz	1N~	6,3 A
FP 260	Grounded plug	230 V at 50 Hz 230 V at 60 Hz	1N~	12,5 A
FP 720	Grounded plug	400 V at 50 Hz 400 V at 60 Hz	3N~	---
FP 056-UL	NEMA 5-15P SJT 14AWG*3C	120 V at 60 Hz	1N~	12,5 A
FP 115-UL	NEMA 5-15P SJT 14AWG*3C	120 V at 60 Hz	1N~	12,5 A
FP 260-UL	NEMA 6-20P SJT 12AWG*3C	240 V at 60 Hz	2~	---
FP 720-UL	NEMA L21-20P	208 V at 60 Hz	3N~	---

- The domestic socket must also provide a protective conductor. Make sure that the connection of the protective conductor of the domestic installations to the chamber's protective conductor meets the latest technology. The protective conductors of the socket and plug must be compatible!

	 <b>DANGER</b>
	<p><b>Electrical hazard due to missing protective conductor connection.</b> <b>Deadly electric shock.</b></p> <p>➤ Make sure that the chamber's power plug and the power socket match and securely connect the electrical protective conductors of the chamber and the house installation.</p>

- Only use original connection cables from BINDER according to the above specification.  
UL chambers: Use only a UL Listed Power supply cord (UL category ELBZ) according to the above specification. For outside USA use a certified power supply cord according to national requirements.
- Prior to connection and start-up, check the power supply voltage. Compare the values to the specified data located on the chamber's type plate (left-hand side of the chamber, chap. 1.6).

	<b>NOTICE</b>
	<p><b>Danger of incorrect power supply voltage due to improper connection.</b> <b>Damage to the chamber.</b></p> <p>➤ Check the power supply voltage before connection and start-up. ➤ Compare the power supply voltage with the data indicated on the type plate.</p>

- When connecting, please observe the regulations specified by the local electricity supply company as well as the local or national electrical regulations (VDE directives for Germany).



- Observe a sufficient current protection according to the number of devices that you want to operate. We recommend the use of a residual current circuit breaker.
- Do not place the power cable over the door gap when the chamber is hot after operation.
- Pollution degree (acc. to IEC 61010-1): 2
- Over-voltage category (acc. to IEC 61010-1): II

See also electrical data (chap. 23.4).



To completely separate the chamber from the power supply, you must disconnect the power plug. Install the chamber in a way that the power plug is easily accessible and can be easily pulled in case of danger.

## 4.2 Connection to an exhaust/ventilation system (optional)

Active suction from the chamber must only be effected together with external air. Therefore, the chamber's exhaust air duct shall not be immediately connected to an active exhaust system.

When connecting to an active exhaust system, proceed as follows:

- Perforate the connecting piece between the exhaust air duct and the exhaust system.

Or

- Use an exhaust air funnel placed in a distance of 3-5 cm / 1 to 2 in from the exhaust air duct. The funnel's opening must be at least twice as large as the diameter of the exhaust air duct.



If improperly connected to an active exhaust/ventilation system, the spatial temperature ex-actitude (uniformity), the heating-up and recovering times as well as the maximum tempera-ture of the chamber may be negatively affected.

The exhaust duct on the chamber rear will become hot during operation



**CAUTION**

**Danger of burning by touching hot chamber parts during operation.**

**Burns.**

∅ Do NOT touch the exhaust duct during operation.

## 4.3 Inserting the racks

Observe the correct orientation of the racks:

**Standard rack:** The lateral brackets must be above the rack surface when inserting the rack.

**Optional heavy load rack:** The lateral brackets must be below the rack surface when inserting the rack.

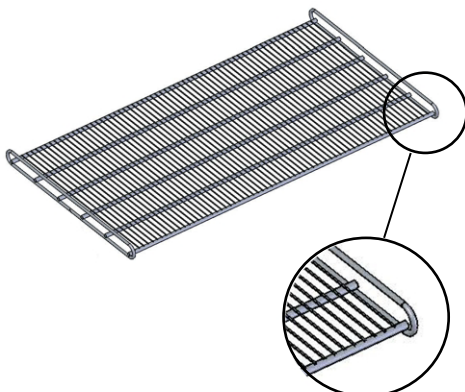

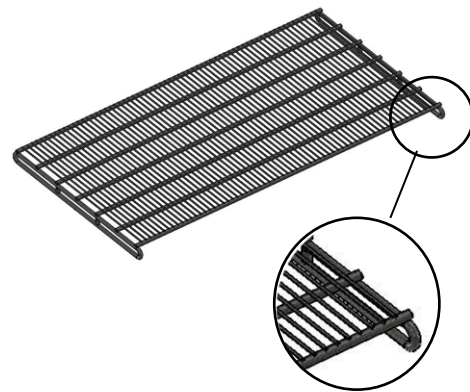

Standard rack



Optional heavy load rack

Figure 11: Correct orientation when inserting the racks

 	 <b>WARNING</b>
	<p><b>Risk of injury by racks falling down due to incorrectly inserting the racks. Injuries.</b></p> <ul style="list-style-type: none"> <li>➤ Use only racks intended for this chamber model.</li> <li>➤ Observe the correct orientation of the racks when inserting them.</li> </ul>

## 5. Functional overview and menu structure of the RD4 chamber controller

The available controller functions depend on the current authorization (chap. 9). Unless noted otherwise, the figure in this manual show the functional range, which is available for the user with "Admin" authorization level.

The RD4 chamber controller controls following parameters inside the chamber:

- Temperature in °C or °F
- Fan speed in %
- Object temperature in °C or °F (object temperatureoption)

You can enter the desired set point values in the "Set points" menu directly at the controller or use the APT-COM™ 4 Multi Management Software (option) specially developed by BINDER.

The controller offers various notifications and alarm messages with visual and audible indication. All controller settings remain valid until the next manual change. They are stored also after turning off the chamber.

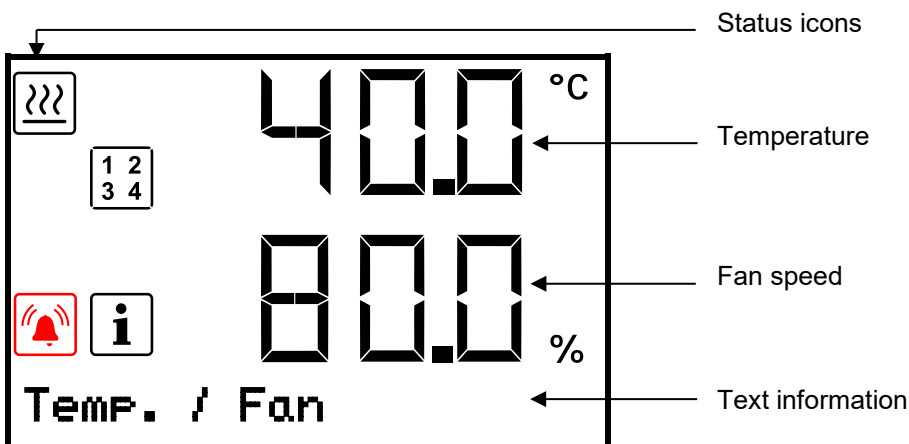











Figure 12: Normal display of the RD4 controller (sample values)

### Status icons in the controller display

Icon	Signification	Icon	Signification
	Heating active		Display of activated special controller functions: 1 = Idle mode 2 = Switching contact 1 3 = Switching contact 2 4 = no function
	Information		
	Collective alarm		

## Functional controller keys

Icon	Signification	Function
	<b>Arrow-up button</b>	<ul style="list-style-type: none"> <li>Navigate between menus, submenus, other functions</li> <li>In the setting menu: change setting, increase value</li> </ul>
	<b>Arrow-down button</b>	<ul style="list-style-type: none"> <li>Navigate between menus, submenus, other functions</li> <li>In the setting menu: change setting, decrease value</li> </ul>
	<b>OK button</b>	<ul style="list-style-type: none"> <li>Select menu, submenu, function</li> <li>In the setting menu: Confirm entry</li> </ul>
	<b>Back button</b>	Back to previous menu level.
	<b>Standby button</b>	no function

### 5.1 Menu structure of the controller and access levels

Starting from **Normal display**, navigate between the menus with the **arrow buttons**.

With the **OK button** you enter the setting of further subordinate menu functions.

With the **Back button** you go back to the previous function and finally back to Normal display.

The available functions depend on the current dependent on the current **authorization** "User", "Admin" or "Service", for which the entry of a password may be required, depending on the setting.

You can set passwords for different access levels:

- **User:** The password enables access to the standard operating functions. Factory setting is 00 00 (no password assigned).
- **Admin:** The password enables access to advanced controller functions and settings. Factory setting is 00 01.
- **Service:** The password enables access to all controller functions (for BINDER Service only).

As soon as a password has been assigned, access to the respective functions is blocked and only available after entering the correct password.

Menu	Required access level	Functions
<b>Setpoints</b>	"User"	<ul style="list-style-type: none"> <li>Temperature set-point setting</li> <li>Setting the safety controller</li> <li>Activating/deactivating operating mode "Idle mode"</li> </ul>
<b>Chamber info</b>	Any user	<ul style="list-style-type: none"> <li>Configuration display (setup information, controller hardware and software, analog inputs)</li> <li>Display of interface configuration (e.g. MAC address, IP address)</li> </ul>
<b>Settings</b>	"Admin"	<ul style="list-style-type: none"> <li>General controller settings (date, time, menu language, temperature unit, display brightness...)</li> <li>Network settings</li> <li>Setting the data logger storage interval</li> <li>Setting the tolerance range limits and delay time for tolerance range alarm</li> <li>Password changing for User and Admin</li> </ul>
<b>Service</b>	"Service"	<ul style="list-style-type: none"> <li>Configuration settings (only for BINDER Service)</li> <li>Password changing for User and Admin</li> </ul>

Menu	Required access level	Functions
<b>USB</b> (visible when inserting a USB stick)	Export: Any user Import: "Admin"	<ul style="list-style-type: none"> <li>• Export of configuration, logger, and service data</li> <li>• Import of configuration data</li> </ul>

Unless noted otherwise, the figure in this manual show the functional range, which is available for the user with "Admin" authorization level

Note: When specifying the path to the respective function, the possibly required entry of a password is not listed

## 5.2 Performance during and after power failures

During a power failure, all controller functions are shut down.

After the power returns, all functions return to the same status the chamber had before power failure. The set-points are immediately resumed.

If during power failure an alarm has occurred (tolerance range, safety controller etc.), confirm the alarm. See chap. 14.

## 5.3 Behavior when opening the door

When opening the door, heating and fan turn off as long as the door remains open.

## 6. Start up

Insert the plug into a suitable socket (chap. 4.1).

FP / FP-UL up to size 260: Turn on the chamber at the on/off switch (4).

FP 720 / FP 720-UL: Turn on the chamber at the main power switch (11) (chap. 2.4).

The lit pilot lamp shows the chamber is ready for operation.

The controller shows normal display and controls temperature and fan speed to the last entered values.

Warming chambers may release odors in the first few days after commissioning. This is not a quality defect. To reduce odors quickly we recommend heating up the chamber to its nominal temperature for one day and in a well-ventilated location.





**WARNING:** If customer should use a BINDER chamber running in non-supervised continuous operation, we strongly recommend in case of inclusion of irrecoverable specimen or samples to split such specimen or samples and store them in at least two chambers, if this is feasible.

### 6.1 Loading

When loading the chamber, observe the maximum permissible load per rack and the maximum permissible total load (see technical data, chap. 23.4).

Observe the correct orientation of the racks (chap. 4.3).

 	<div style="background-color: orange; text-align: center; padding: 5px;">  <b>WARNING</b> </div> <p><b>Risk of injury by racks falling down due to overload.</b></p> <p><b>Injuries.</b></p> <ul style="list-style-type: none"> <li>∅ Do not exceed the maximum permissible load per rack.</li> <li>∅ Do not exceed the maximum permissible total load.</li> <li>➤ Gently place the load on the racks.</li> <li>➤ Distribute the load as evenly as possible.</li> </ul>
---	--

## 6.2 Controller settings upon start up

Depending on the functions activated in the controller, various settings can be requested directly after turning on the chamber.

Then you should assign a password for the operating level (chap. 9).

If the function “Language selection at restart” has been activated (chap. 12.5, factory setting ON), the following settings are checked upon start up:

- **Menu language** (chap. 12.1):  
Use the **arrow buttons** to select the desired language, confirm with the **OK button**
- **Temperature unit** (chap. 12.2):  
Use the **arrow buttons** to select the desired temperature unit, confirm with the **OK button**
- **Current date** (chap. 12.3), format DD MM YYYY:  
Use the **arrow buttons** to set the day, continue with the **OK button**.  
Use the **arrow buttons** to set the month, continue with the **OK button**.  
Use the **arrow buttons** to set the year, confirm with the **OK button**
- **Current time** (chap. 12.4), format HH:MM:  
Use the **arrow buttons** to set the hours, continue with the **OK button**.  
Use the **arrow buttons** to set the minutes, confirm with the **OK button**

## 6.3 Setting the displayed decimal places

Required authorization: „Admin“.

Path: **Normal display** ▾ ▾ ▾ ▾ **Settings**  ▾ ▾ ▾ **Various**  ▾ ▾ ▾ **Decimal places**

Press the **OK button** to enable the setting.



Setting the display precision / decimal places.

The current setting flashes. Use the **arrow buttons** to enter the desired decimal places: “0” or “1”. Factory setting: 0.

Confirm the entry with the **OK button**.

With the **Back button** you can go back to the “**Various**” submenu and, repeatedly pressing it, to **Normal display**.

## 7. Set-point entry

	Setting ranges	Control ranges
Temperature	0.0 °C / 32 °F up to 330.0 °C / 572 °F	10 °C / 18 °F above ambient temperature up to 300 °C / 572 °F
Fan speed	40 % up to 100 %	

### 7.1 Temperature set-point entry

Required access level: "User".

Path: **Normal display**  **Setpoints**  **Temperature**

Press the **OK button** to enable the setting.

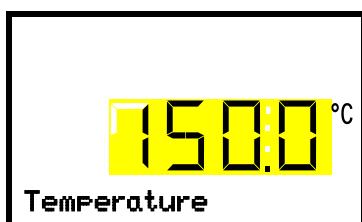

Temperature setting.

The current setting flashes. Enter the desired set-point with the **arrow buttons**.

Confirm the entry with the **OK button**.

With the **arrow-down button** you can continue with the fan speed set-point entry (chap. 7.2).

With the **Back button** you can go back to the "**Setpoints**" submenu and, repeatedly pressing it, to **Normal display**.



With safety controller mode "**Limit**", adapt the safety controller always when you changed the temperature set-point. Set the safety controller value by approx. 5 °C above the temperature set-point (chap. 11.2).

Recommended setting: safety controller mode "**Offset**" with safety controller value 5 °C.

### 7.2 Fan speed set-point entry

Required access level: "User".

Path: **Normal display**  **Setpoints**  **Fan speed**

Press the **OK button** to enable the setting.

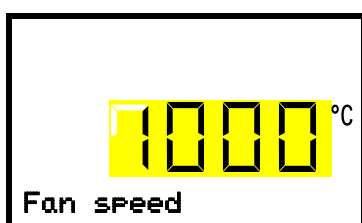

Fan speed setting.

The current setting flashes. Enter the desired set-point with the **arrow buttons**.

Confirm the entry with the **OK button**.

With the **arrow-up button** you can go back to the temperature set-point entry (chap. 7.1).

With the **arrow-down button** you can continue with setting the air flap position (chap. 7.3).

With the **Back button** you can go back to the "**Setpoints**" submenu and, repeatedly pressing it, to **Normal display**.

### 7.3 Adjusting the air flap position

Opening the air flap in the exhaust duct serves to adjust the air change.

The position of the air flap in the exhaust duct serves to adjust the fresh air entry. With the open the air flap, fresh air can enter through the fresh air tube. For chambers with fan, fan operation will increase fresh air entry.

If the air flap is completely open, the spatial temperature accuracy can be negatively influenced.

The position of the air flap can be controlled via the controller and the written program.

There are the following options:

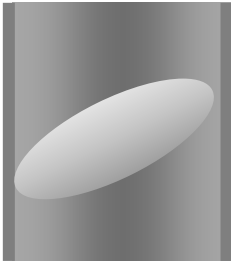
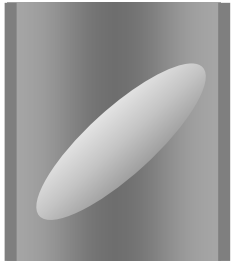
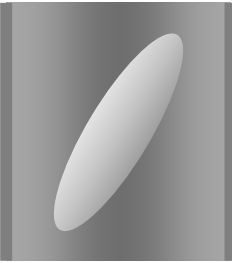
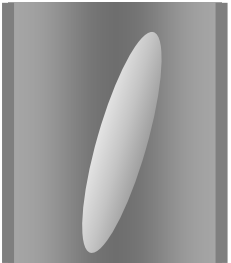
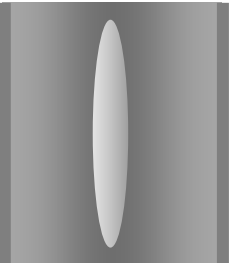
Air flap closed 0	Air flap slightly opened 1	Air flap half opened 2	Air flap almost open 3	Air flap open 4
				

The setting can be done in steps of 15°.

Required access level: "User".

Path: **Normal display**  **Setpoints**   **Air flap**

Press the **OK button** to enable the setting.

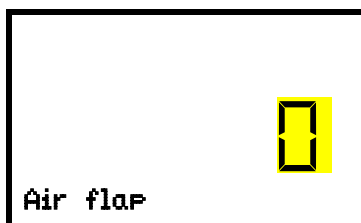

Adjusting the air flap position

The current setting flashes. Enter the desired set-point with the **arrow buttons**.

Confirm the entry with the **OK button**.

With the **arrow-up button** you can go back to the fan speed entry (chap. 7.2).

With the **arrow-down button** you can now change to the special controller functions setting (chap. 8).

With the **Back button** you can go back to the "Setpoints" submenu and, repeatedly pressing it, to **Normal display**.



As part of an automatic function test, the exhaust air flap opens briefly every 24 hours.

## 8. Setting special controller functions

Required access level: "User".

Path: **Normal display**  **Setpoints**     **Functions on/off**

You can define the switching state of up to four controller functions.

- Function 1 "Idle mode" serves to deactivate all chamber functions except the controller. With operating mode "Idle mode", the heating and fan are deactivated.
- Function 2 : "Switching output 1" is used to switch on/off the zero-voltage switching contact 1
- Function 3 : "Switching output 2" is used to switch on/off the zero-voltage switching contact 2

Function 4 is not used with this chamber.

The functions are displayed from left to right.

**Example:** Function 1 activated = 1000. Function 1 deactivated = 0000.

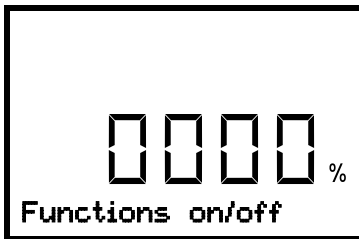

Submenu "Functions on/off".

This view shows the switching states of the four controller functions.

"1" = Function activated

"0" = Function deactivated

Press the **OK button** to access the first individual function. With the **arrow-down button** you can proceed to the subsequent functions and access it with the **OK button**.

Then press the **OK button** to enable the setting of the desired function and select the function's switching state "1" (function activated) or "0" (function deactivated).

**Example:** Function 1 "Idle mode"

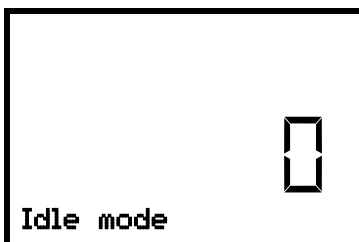

Function 1 "Idle mode".

The current switching state is shown (example).

Press the **OK button** to enable the setting.

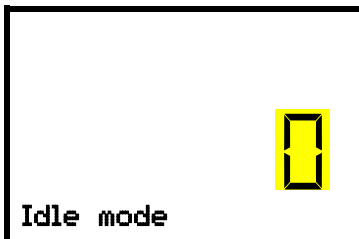

Setting function 1 "Idle mode".

The current setting flashes. Use the **arrow buttons** to select between 0 (deactivated function) and 1 (activated function).

Confirm the setting with the **OK button**.

With the **Back button** you can go back to the "**Functions on/off**" submenu and, repeatedly pressing it, to **Normal display**.

In Normal display the activated functions are indicated by an icon showing the number of the respective function. The "Info" icon flashes slowly. While it is lit, the lower text informs about the activated functions.

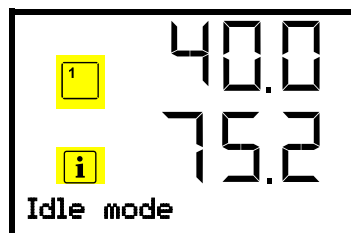
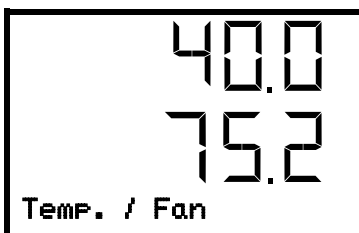

Example:

Normal display with activated function 1 "Idle mode".

If several functions are active at the same time, the icon shows the combination of the corresponding numbers, e.g. .



## 9. Authorization levels and password protection

### 9.1 Password request

To access menus for which access is restricted, you must enter the corresponding password.

After calling the appropriate menu function with the **OK button** the password request appears.

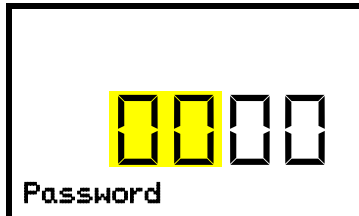

Password request.

The left two digits are flashing. Enter the desired numbers with the **arrow buttons**.

Confirm the setting with the **OK button**.

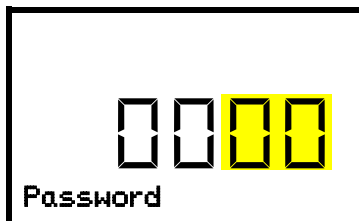

Password request.

The right two digits are flashing. Enter the desired numbers with the **arrow buttons**.

Confirm the setting with the **OK button**.

Upon entering an incorrect password, the message "Wrong password" is displayed.

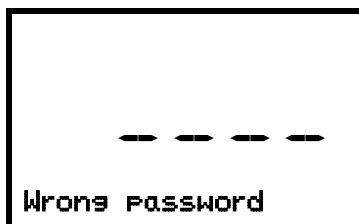

Display "Wrong password".

After 3 seconds the controller changes again to the password entry.

Enter the correct password.

Following correct password entry, you can access the desired menu function.

### 9.2 Assign and modify a password

In this menu you can assign and modify the passwords of the "User" and "Admin" access levels.

Required access level: "Admin".

#### 9.2.1 Assign and modify the User password

Path: **Normal display**     **Settings**  **Chamber**     **Password User**

Press the **OK button** to enable the setting.

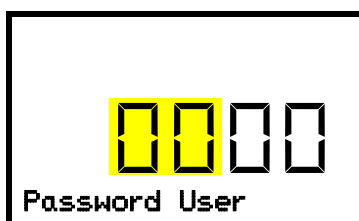

Setting the User password.

The left two digits are flashing. Enter the desired numbers with the **arrow buttons**.

Confirm the setting with the **OK button**.

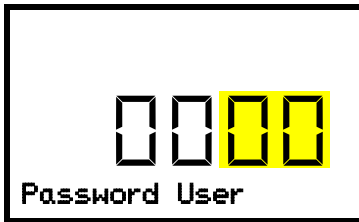

Setting the User password.  
The right two digits are flashing. Enter the desired numbers with the **arrow buttons**.  
Confirm the setting with the **OK button**.

With the **arrow-down button** you can now proceed to enter the Admin password.

With the **Back button** you can go back to the "Chamber" submenu and, repeatedly pressing it, to **Normal display**.



Keep the password well in mind. There is no access to the corresponding menu functions without the correct password.

## 9.2.2 Assign and modify the Admin password

Path: **Normal display** ▾ ▾ ▾ ▾ **Settings**  **Chamber** ▾ ▾ ▾ ▾ **Password Admin**

Press the **OK button** to enable the setting.

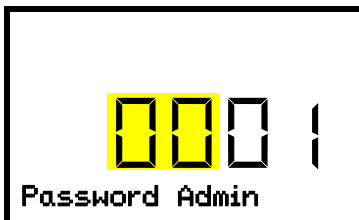

Setting the Admin password.  
The left two digits are flashing. Enter the desired numbers with the **arrow buttons**.  
Confirm the setting with the **OK button**.



Setting the Admin password.  
The right two digits are flashing. Enter the desired numbers with the **arrow buttons**.  
Confirm the setting with the **OK button**.

With the **Back button** you can go back to the "Chamber" submenu and, repeatedly pressing it, to **Normal display**.



Keep the password well in mind. There is no access to the corresponding menu functions without the correct password.

## 10. FailSafe function

The chambers are equipped with the "FailSafe" safety function: The chamber has two Pt100 temperature sensors for mutual monitoring and function takeover in the event of an error.

The **regular temperature sensor** normally supplies the temperature data. In the event of an error, i.e. if it no longer supplies any data that can be processed, the additional **FailSafe temperature sensor** takes over the recording of the measured values. For information, the alarm message "Sensor defective!" is issued (chap. 14.2), but the chamber continues to function and displays the correct temperature value.

Contact BINDER Service to replace the defective sensor.

## 11. Overtemperature protection

### 11.1 Overtemperature protective device class 1

The chambers are regularly equipped with an overtemperature protective device (bimetallic switch) safety device class 1 acc. to DIN 12880:2007. It serves to protect the chamber, its environment and the contents against exceeding the maximum permissible temperature. When a defined cut-off temperature is reached, the overtemperature protective device turns off the heating.

**Cut-off temperature values:**

FP 56: 330 °C / 626 °F

FP 115, FP 260, FP 720: 350 °C / 662 °F

The message "Overtemperature" is displayed on the controller.

If the overtemperature protective device class 1 has turned off the heating, proceed as follows:

- Disconnect the controller from the power supply for at least 10 seconds (operating the on/off switch (4) or main power switch (11) or pull the power plug).
- If appropriate, have an expert examine and rectify the cause of the fault.
- Let the chamber cool down
- Restart the chamber.

As soon as the inner chamber temperature after restart is below the defined cut-off temperature of the overtemperature protective device class 1, the alarm message is deleted automatically.

## 11.2 Overtemperature safety controller class 2 / 3.1

The chambers are regularly equipped with an adjustable electronic safety controller. It serves to protect the chamber, its environment and the contents against exceeding the maximum permissible temperature. Please observe the regulations applicable to your country (for Germany: DGUV guidelines 213-850 on safe working in laboratories, issued by the employers' liability insurance association).

Note: The function of the safety controller does not affect the function of the class 1 overtemperature protection device (bimetallic switch), as both are connected in series. Both signals are therefore required for the chamber to be operational.

In the controller menu you can select between a safety controller class 2 ("temperature limiter") or class 3.1 ("temperature protection") acc. to DIN 12880:2007:

- The **safety controller class 2** must be acknowledged with the OK button before the heating is switched on again.
- The **safety controller class 3.1**, on the other hand, switches the heating on again automatically when the temperature falls below the the selected safety controller set-point.

- **Safety controller class 2 ("temperature limiter")**

The safety controller class 2 limits the temperature inside the chamber to the entered safety controller set-point. In the event of a fault (if this maximum temperature is exceeded) the safety controller completely turns off the heating until manual reset.

This condition (state of alarm) is indicated visually and additionally with an audible alert if the buzzer is enabled (chap. 14.3). You can turn off the buzzer with the **OK button**. The alarm persists until the chamber cools down below the configured safety controller value. The heating is only switched on again if the class 2 safety controller has been acknowledged with the **OK button**.

If the safety controller class 2 has turned off the heating, we recommend proceeding as follows:

- Disconnect the chamber from the power supply.
- Have an expert examine and rectify the cause of the fault.
- Restart the chamber
- Reset the alarm message

- **Safety controller class 3.1 ("temperature protection")**

The safety controller class 3.1 limits the temperature inside the chamber to the entered safety controller set-point. In the event of a fault (if this maximum temperature is exceeded), it takes over the control to this value. This condition (state of alarm) is indicated visually and additionally with an audible alert if the buzzer is enabled (chap. 14.3).

The safety controller keeps control of the chamber until the chamber temperature cools down below the safety controller set-point value. When the chamber cools down below the configured safety controller value, the heating is activated again. You can then reset the alarm on the controller.

If the safety controller class 3.1 has taken over control, we recommend proceeding as follows:

- Disconnect the chamber from the power supply.
- Have an expert examine and rectify the cause of the fault.
- Restart the chamber
- Reset the alarm message

### 11.2.1 Selecting between safety controller class 2 (temperature limiter) or class 3.1

You have the option of operating the safety controller with class 2 or 3.1 functionality.

Erforderliche Berechtigung: „Admin“.

Path: **Normal display**     **Settings**     **Various**    **Protection class**

Press the **OK button** to enable the setting.



Selecting the class of the safety controller.

The current setting flashes. Use the **arrow buttons** to enter the desired class: “3.1” or “2.0”. Factory setting: class 2.

Confirm the entry with the **OK button**.

With the **Back button** you can go back to the “**Various**” submenu and, repeatedly pressing it, to **Normal display**.

The functionality of the safety controller and the corresponding setting menus in the controller are adapted to the selection made here.

### 11.2.2 Safety controller mode

You can set the **safety controller mode** to “Limit” or “Offset”.

- **Limit:** Limit value, absolute maximum permitted temperature value

This setting offers high safety as a defined temperature limit will not be exceeded. It is important to adapt the safety controller value after each modification of the temperature set-point. Otherwise, the limit could be too high to ensure efficient protection, or, in the opposite case, it could prevent the controller from reaching an entered set-point outside the limit range.

- **Offset:** Offset value, maximum overtemperature above any active temperature set point. The resulting maximum temperature changes internally and automatically with every temperature set-point change.

#### Example:

Desired temperature value: 40 °C, desired safety controller value: 45 °C.

Possible settings for this example:

Temperature set point	Safety controller mode	Safety controller value
40 °C	Limit	Limit value 45 °C
	Offset	Offset value 5 °C



Check the setting regularly and adjust it following changes of the set-point or charge.

### 11.2.3 Setting the safety controller mode

Required access level: “User”.

Path: **Normal display**  **Setpoints**       **Safety controller**  **Mode**

Press the **OK button** to enable the setting.

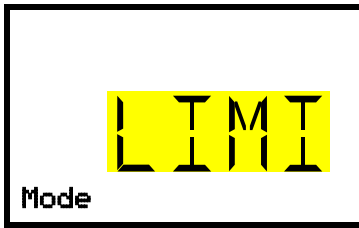

Setting the safety controller mode  
 The current setting flashes. Use the **arrow buttons** to select between LIM I (Limit) and OFF S (Offset).  
 Confirm the setting with the **OK button**.

With the **arrow-down button** you proceed to setting the safety controller value (chap. 11.2.4)

With the **Back button** you can go back to the “**Safety controller**” submenu and, repeatedly pressing it, to **Normal display**.

### 11.2.4 Setting the safety controller value

Required access level: “User”.

The desired safety controller mode must be selected first (chap. 11.2.3). Depending on the mode setting, one of the following setting menus will appear.

Path: **Normal display** ▾ **Setpoints**       **Safety controller**   **Limit or Offset**

Press the **OK button** to enable the setting.



Setting the safety controller value with “Limit” safety controller mode.  
 The current value flashes. Enter the desired limit value with the **arrow buttons**.  
 Confirm the entry with the **OK button**.

or



Setting the safety controller value with “Offset” safety controller mode.  
 The current value flashes. Enter the desired offset value with the **arrow buttons**.  
 Confirm the entry with the **OK button**.

With the **Back button** you can go back to the “**Safety controller**” submenu and, repeatedly pressing it, to **Normal display**.



Regularly check the settings of the safety controller mode and value.  
 Set the safety controller value by approx. 2 °C to 5 °C above the desired temperature set-point.

### 11.2.5 Message and measures in the state of alarm

The state of alarm is indicated visually in Normal display. If the buzzer is enabled (chap. 14.3) there is an additional audible alert. The heating turns off. As soon as the inner chamber temperature has cooled down below the safety controller value, the heating can be released (class 2) or the heating is released (class 3.1), and temperature control continues.

In Normal display a text message indicates the alarm cause. The “collective alarm” icon is lit. If the audible arm is activated, the buzzer sounds. Press the **OK button** to mute the buzzer.

The alarm message “Safety controller” and the “Collective alarm” icon are displayed on the controller until you press the **OK button** on the controller **and** the inner chamber temperature has cooled down below the safety controller value.

- If the inner chamber temperature has already cooled down below the safety controller value when pressing the **OK button**, the alarm message “Safety controller” and the “Collective alarm” icon are reset together with the buzzer.
- If the state of alarm is still active when pressing the **OK button**, i.e. the inner chamber temperature is still above the safety controller value, first only the buzzer is reset. The alarm message “Safety controller” and the “Collective alarm” icon will disappear as soon as the inner chamber temperature falls below the safety controller value.

The alarm remains active until it is acknowledged on the controller and the inner temperature falls below the entered safety controller setpoint. Then the heating is released again.

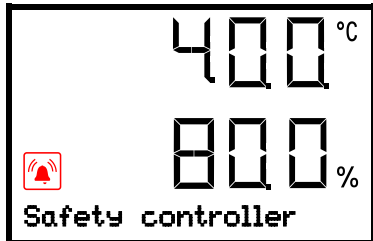

Normal display showing safety controller alarm (sample values)

**Note:** When the safety controller had been activated you should disconnect the chamber from the power supply and have an expert examine and rectify the cause of the fault.

### 11.3 Function check

Check the safety controller at appropriate intervals for its functionality. It is recommended that the authorized operating personnel should perform such a check, e.g., before starting a longer work procedure.

## 12. General controller settings

The general settings can be accessed in the “**Settings**” submenu, which is available for users with “Service” or “Admin” authorization level. It serves to enter date and time, select the language for the controller menus and the desired temperature unit and to configure the controller’s communication functions.

The display of some network settings is available for all users in the “**Chamber info**” menu.

### 12.1 Selecting the controller’s menu language

The RD4 controller communicates by a menu guide using real words in German, English, French, Spanish, and Italian languages.

Required access level: “Admin”. Following start-up of the chamber (chap. 6), it is “User”.

Path: **Normal display**     **Settings**  **Chamber**    **Language\***

\* Following start-up of the chamber: **Sprache / Language / Langue / Idioma / Lingua**, depending on the language selected before turning off the chamber

Press the **OK button** to enable the setting.

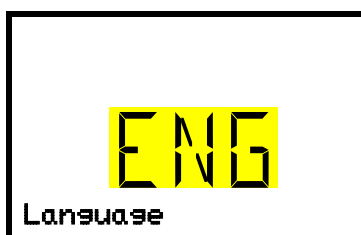

Setting the menu language (example: English).

The current setting flashes. Use the **arrow buttons** to select the desired language.

Confirm the entry with the **OK button**.

With the **arrow-down button (twice)** you can now change to the temperature unit setting.

With the **Back button** you can go back to the “**Chamber**” submenu and, repeatedly pressing it, to **Normal display**.

## 12.2 Selecting the temperature unit

Required access level: "Admin". Following start-up of the chamber (chap. 6), it is "User".

Path: **Normal display** ▾ ▾ ▾ ▾ **Settings**  **Chamber**  ▾ ▾ ▾ ▾ **Temperature unit**

Press the **OK button** to enable the setting.

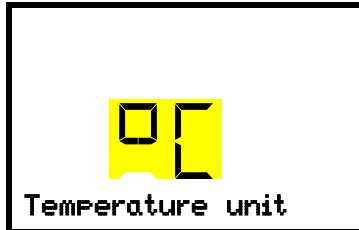

Setting the temperature unit

The current setting flashes. Use the **arrow buttons** to select between °C (degrees Celsius) and °F (degrees Fahrenheit).

Confirm the entry with the **OK button**.

You can change the temperature unit between °C and °F.

If the unit is changed, all values are converted accordingly

	C = degree Celsius	0 °C = 31°F	Conversion:
	F = degree Fahrenheit	100 °C = 212°F	[value in °F] = [value in °C] * 1,8 + 32

With the **Back button** you can go back to the "**Chamber**" submenu and, repeatedly pressing it, to **Normal display**.

## 12.3 Setting the current date

Required access level: "Admin". Following start-up of the chamber (chap. 6), it is "User".

Path: **Normal display** ▾ ▾ ▾ ▾ **Settings**  **Chamber**  **Date**

Press the **OK button** to enable the setting.



Setting the date: day

The current setting flashes. Enter the current day with the **arrow buttons**.

Confirm the entry with the **OK button**.

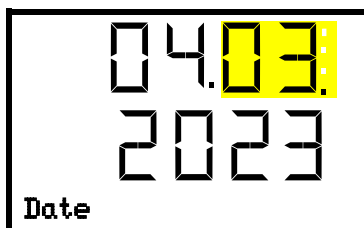

Setting the date: month

The current setting flashes. Enter the current month with the **arrow buttons**.

Confirm the entry with the **OK button**.

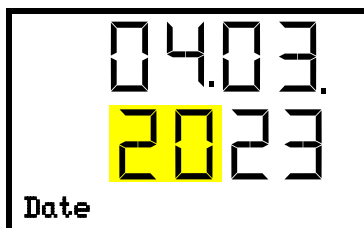

Setting the date: year

The left two digits are flashing. Enter the first two digits of the current year with the **arrow buttons**.

Confirm the entry with the **OK button**.



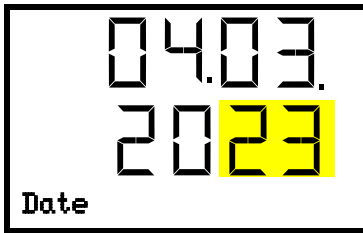

Setting the date: year

The right two digits are flashing. Enter the last two digits of the current year with the **arrow buttons**.

Confirm the entry with the **OK button**.

With the **arrow-down button** you can now change to setting the current time.

With the **Back button** you can go back to the “**Chamber**” submenu and, repeatedly pressing it, to **Normal display**.

## 12.4 Setting the current time

Required access level: “Admin”. Following start-up of the chamber (chap. 6), it is “User”.

Path: **Normal display**     **Settings**  **Chamber**   **Time**

Press the **OK button** to enable the setting.

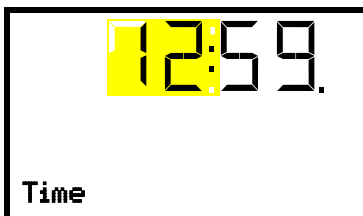

Setting the time: hours

The current setting flashes. Enter the current hour with the **arrow buttons**.

Confirm the entry with the **OK button**.

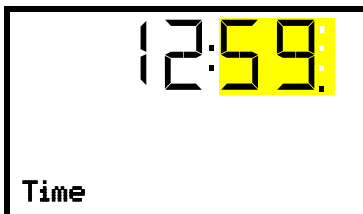

Setting the time: minutes

The current setting flashes. Enter the current minutes with the **arrow buttons**.

Confirm the entry with the **OK button**.

With the **Back button** you can go back to the “**Chamber**” submenu and, repeatedly pressing it, to **Normal display**.

## 12.5 Function “Language selection at restart”

If the function “Language selection at restart” is activated, menu language, date, time, and temperature unit are checked with every startup of the chamber. At this occasion it is also possible to modify them with “User” access level.

Required access level: “Admin”.

Path: **Normal display**     **Settings**  **Chamber**     **Language selection at restart**

Press the **OK button** to enable the setting.



Function “Language selection at restart”

The current setting flashes. Use the **arrow buttons** to select between ON and OFF.

Confirm the setting with the **OK button**.

With the **arrow-down button** you can now change to the next parameter (chamber address).

With the **Back button** you can go back to the “**Chamber**” submenu and, repeatedly pressing it, to **Normal display**.

## 12.6 Setting the chamber address

This setting is required for the communication with the BINDER APT-COM™ 4 Multi Management Software. The chamber address settings in the chamber controller and in the software must be identical.

Required access level: "Admin".

Path: **Normal display** ▾ ▾ ▾ ▾ **Settings**  **Chamber**  ▾ ▾ ▾ ▾ ▾ **Chamber address**

Press the **OK button** to enable the setting.



Setting the chamber address

The current setting flashes. Enter the desired address with the **arrow buttons**. Setting range: 1 up to 254

Confirm the entry with the **OK button**.

With the **arrow-down button** you can now change to the next parameter (display brightness).

With the **Back button** you can go back to the "Chamber" submenu and, repeatedly pressing it, to **Normal display**.

## 12.7 Display brightness

Required access level: "Admin".

Path: **Normal display** ▾ ▾ ▾ ▾ ▾ **Settings**  **Chamber**  ▾ ▾ ▾ ▾ ▾ **Brightness**

Press the **OK button** to enable the setting.



Setting the display brightness

The current setting flashes. Enter the desired value with the **arrow buttons**. Setting range: 10% up to 100%

Confirm the entry with the **OK button**.

With the **arrow-down button** you can now change to the next parameter (audible alarm, chap. 14.3).

With the **Back button** you can go back to the "Chamber" submenu and, repeatedly pressing it, to **Normal display**.

## 13. Tolerance range settings

In this menu you can define the deviation between the actual value and setpoint, which shall cause a tolerance range alarm. The entered value defines the limit of permitted deviations from the set-point (exceeding and falling below). Reaching this limit triggers tolerance alarm.

In addition, you can specify a delay time for this alarm.

If the actual value is outside the tolerance range, after the configured alarm delay time the alarm message "Temperature range" is displayed in Normal display (chap. 14.2). If the alarm buzzer is activated (chap. 14.3) there is an audible alert.

This function only activates after the set-point has been reached once.

Required access level: "Admin".

### 13.1 Setting the delay time for tolerance range alarm

Path: **Normal display** ▾ ▾ ▾ ▾ **Settings**  ▾ ▾ ▾ **Various**  **Range alarm delay (min)**

Press the **OK button** to enable the setting.

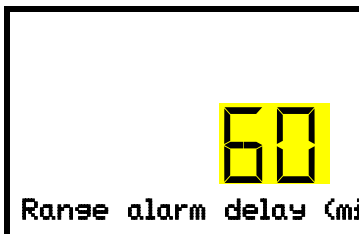

Setting the tolerance range alarm delay.

The current setting flashes. Use the **arrow buttons** to enter the desired time after which the range alarm shall be triggered. Entry range: 1 up to 300 minutes. Factory setting: 60 minutes.

Confirm the entry with the **OK button**.

With the **arrow-down button** you can now change to the temperature tolerance range setting.

With the **Back button** you can go back to the "**Various**" submenu and, repeatedly pressing it, to **Normal display**.

### 13.2 Setting the temperature tolerance range

Path: **Normal display** ▾ ▾ ▾ ▾ **Settings**  ▾ ▾ ▾ **Various**  ▾ **Temperature range**

Press the **OK button** to enable the setting.

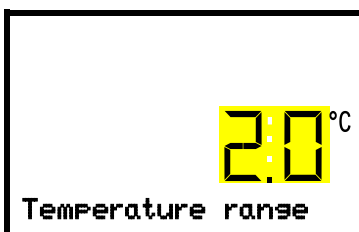

Setting the temperature tolerance range

The current setting flashes. Enter the desired temperature range with the **arrow buttons**. Entry range: 1.0 °C up to 10.0 °C

Confirm the entry with the **OK button**.

With the **arrow-up button** you can go back to the tolerance range alarm delay setting.

With the **arrow-down button** you can now change to selecting the safety controller class (chap. 11.2.1).

With the **Back button** you can go back to the "**Various**" submenu and, repeatedly pressing it, to **Normal display**.

## 14. Notification and alarm functions

### 14.1 Information messages

Information messages provide information about the settings made or the current controller condition. The message is displayed immediately when the condition occurs.

 In Normal display a text message indicates the condition. The “Information” icon is flashing slowly.

To confirm the information message, press the **OK button**.

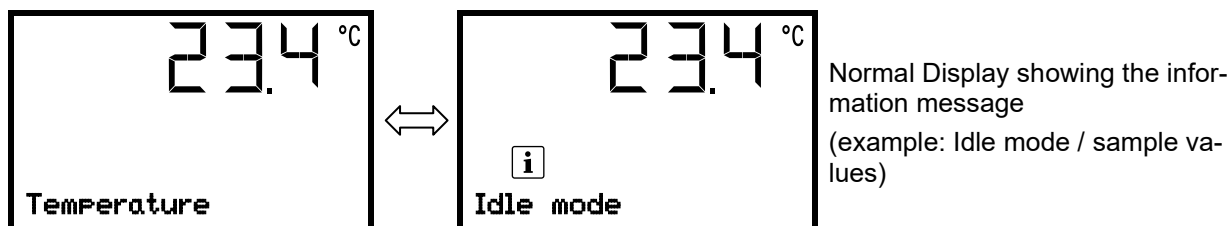

If there are several information messages, they are displayed one after the other.



#### Information messages overview:

Condition	Information message
“Idle Mode”function has been activated in the „Functions on/off“ menu	“Idle Mode”
A time program is executed	“Time program active”
A week program is executed	“Week program active”
Recommended maintenance interval (one year of operation) is over. This message is displayed after each week of operating time once the maintenance interval has expired	“Service due!”

Press the **OK button** to confirm the information message.

Additionally, the activated functions are indicated by an icon in Normal display showing the number of the respective function.

#### Overview of the information icons of the activated controller functions:

Condition	Information icon in Normal display
Idle Mode	
Switching contact 1	
Switching contact 2	

If several functions are simultaneously active, the icon displays a combination of the corresponding numbers, e.g. 

### 14.2 Alarm messages

In the event of equipment failures, and when the temperature deviates from the set tolerance range limits, optical and possibly acoustic alarm messages are given out via the controller.

The alarm messages on leaving the tolerance range are emitted after a configurable delay, the others immediately when the fault occurs. The tolerance range alarm is suppressed after turning on the chamber until the setpoint is reached and then for the selected delay time.



In Normal display a text message indicates the alarm cause. The collective alarm icon flashes. If the audible arm is activated, the buzzer sounds.

Press the **OK button** to confirm the alarm and mute the buzzer. If the alarm cause is still valid, the collective alarm icon is lit.



Alarm indication (example: safety controller alarm)

#### Alarm messages overview:

Condition	Alarm message	Start after condition occurred
Tolerance range alarm: actual temperature value exceeding the tolerance range	"Temperature range alarm"	after configurable time (chap. 13.1) Factory setting: 10 minutes
Overtemperature protective device class 1 (thermal switch) activated	"Overtemperature"	immediately
Setpoint of the safety controller class 3.1 exceeded	"Safety contr. class 3.1"	immediately
Setpoint of the safety controller class 2 exceeded	"Safety contr. class 2"	immediately
Regular temperature sensor defective. The FailSafe temperature sensor takes over the measurement (chap. 10)	"Sensor defective!"	immediately
FailSafe temperature sensor or safety controller temperature sensor defective	"Safety contr. class 3.1" or "Safety contr. class 2", message not resettable	immediately
Regular temperature and FailSafe temperature sensor defective (chap. 10)	Actual temperature value display shows " _ _ _ _ "	immediately
Failure of temperature sensor for object temperature (option)	Object temperature display shows " _ _ _ _ "	immediately

All alarms are given out via the zero-voltage relay alarm contact (chap. 14.4).

Press the **OK button** to confirm the alarm.

- Confirmation while the state of alarm persists: Only the buzzer is muted. The visual alarm message continues to be displayed until the alarm condition is removed. Then it is reset automatically.
- Confirmation after the alarm has ended: The buzzer and the visual alarm message are reset together.

### 14.3 Activating / deactivating the audible alarm (alarm buzzer)

Path: **Normal display**     **Settings**  **Chamber**         **Audible alarm**

Press the **OK button** to enable the setting.

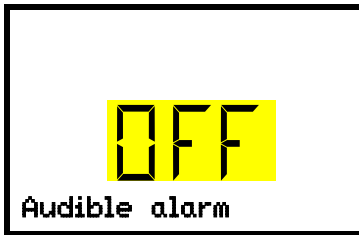

Setting the audible alarm.

The current setting flashes. Use the **arrow buttons** to select between ON and OFF.

Confirm the setting with the **OK button**.

With the **Back button** you can go back to the “Chamber” submenu and, repeatedly pressing it, to **Normal display**.

## 14.4 Zero-voltage relay alarm contact

### Collective alarm output via the zero-voltage relay alarm contact

The chamber is equipped at the rear with a zero-voltage relay **contact** (6), which permits the transmission of alarms generated by the chamber to an external monitoring system in order to monitor and record the alarm signals.

The connection is realized as 9-poles SUB-D socket “ALARM / SWITCH CONTACT” (6) as follows.

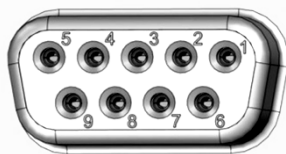

PIN 7 = C  
PIN 8 = NO  
PIN 9 = NC

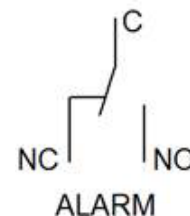

Figure 13: Pin configuration of the SUB-D socket “ALARM / SWITCH CONTACT” (6) for zero-voltage relay alarm contact



The zero-voltage relay alarm output switches immediately, as soon as the “Collective alarm” icon lights up. The zero-voltage relay alarm output switches for all alarm instances and in case of a power failure.

If the external alarm monitor is connected via the contacts C and NO, alarm monitoring will take place with protection against short-circuiting, i.e., if the connection between the chamber and the external alarm monitor is interrupted, an alarm is triggered. In this case, power failure will also trigger the alarm.

When the chamber is running and there is no alarm, contact C closes with contact NO.

When the chamber is turned off or if there is an active alarm, contact C closes with contact NC.

### Maximum loading capacity of the switching contacts: 24V AC/DC – 2.0 Amp.

	 <b>DANGER</b>
	<p><b>Electrical hazard through overload of switching contacts.</b>  <b>Deadly electric shock, damage to switching contacts and connection socket.</b></p> <ul style="list-style-type: none"> <li>∅ Do NOT exceed the maximum switching load of 24V AC/DC – 2.0 Amp.</li> <li>∅ Do NOT connect any devices with a higher loading capacity.</li> </ul>

The alarm message on the controller display remains displayed during transmission of an alarm via the zero-voltage relay outputs. As soon as the cause of the alarm is rectified, or the alarm message has been reset, the alarm transmission via the zero-voltage relay outputs is reset together with the alarm message on the controller display.

In case of power failure, transmission of the alarm via zero-voltage relay outputs remains active for the duration of the power failure. Afterwards, the contact closes automatically.

## Connection to an external monitoring system

To ensure short-circuit-proof alarm monitoring that will trigger the alarm when connected to an external alarm monitor, connect the external alarm monitoring system to the chamber via the connection socket (6) of the zero-voltage relay output.

## 15. Program start / stop function

You can start and stop time or week programs at the RD4 controller.

**Time programs:** Programming is done using the APT-COM™ 4 Multi Management Software from BINDER (chap.19.1). There you can create the programs and transfer them to the chamber controller.

You can also use the BINDER RD4 Program Editor, which you can download from the BINDER website. The RD4 program editor is a Windows application that can be used to create programs on a PC and transfer them to compatible BINDER chambers via USB memory stick.

**Week programs:** Programming is done using the BINDER RD4 Program Editor, which you can download from the BINDER website. The RD4 program editor is a Windows application that can be used to create programs on a PC and transfer them to compatible BINDER chambers via USB memory stick.

Required access level: "User".

### 15.1 Start time program

Path: **Normal display**   **Programs**  **Time program**

Press the **OK button** to enter the program start submenu.

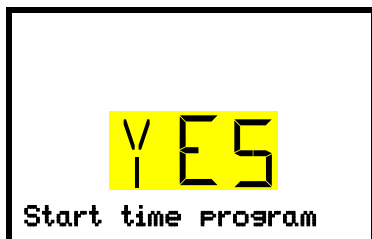

"Start time program" submenu

The current setting flashes. Select with the **arrow buttons** between YES (start time program) and NO (do not start time program).

To start the time program, select "YES" and press the **OK button** to confirm.

With the **Back button** you can go back to the "**Programs**" submenu and, repeatedly pressing it, to **Normal display**.

After selecting "NO": The controller changes back to Normal display.

After selecting "YES": The time program starts, the controller displays the information "Program started". Press the **OK button**. The controller changes to Normal display. The information "Time program active" is displayed alternately with "Temperature".

### 15.2 Start week program

Path: **Normal display**   **Programs**   **Week program**

Press the **OK button** to enter the program start submenu.



"Start week program" submenu

The current setting flashes. Select with the **arrow buttons** between YES (start week program) and NO (do not start week program).

To start the week program, select "YES" and press the **OK button** to confirm.

With the **Back button** you can go back to the "**Programs**" submenu and, repeatedly pressing it, to **Normal display**.

After selecting “NO”: The controller changes back to Normal display.

After selecting “YES”: The week program starts, the controller displays the information “Program started”. Press the **OK button**. The controller changes to Normal display. The information “Week program active” is displayed alternately with “Temperature”.

### 15.3 Stop program

Path: **Normal display**   **Programs**   **Stop program**

Press the **OK button** to activate the settings.

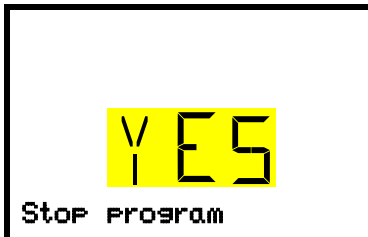

“Stop program” submenu

The current setting flashes. Select with the **arrow buttons** between YES (stop program) and NO (do not stop program).

To stop the week program, select “YES” and press the **OK button** to confirm.

With the **Back button** you can go back to the “**Programs**” submenu and, repeatedly pressing it, to **Normal display**.

After selecting “NO”: The controller changes back to Normal display. The program continues.

After selecting “YES”: The program stops. Press the **OK button**. The controller changes to Normal display.

## 16. Ethernet network settings

The settings of this submenu are used for networking chambers with an Ethernet interface, e.g. to connect them with BINDER’s APT-COM™ 4 Multi Management Software (option, chap. 19.1).

### 16.1 Showing the network settings

Required access level: “User”.

The “Ethernet” submenu offers to subsequently or individually access the following information:

- MAC address
- IP address
- Subnet mask
- Standard gateway
- DNS server address
- DNS chamber name

#### 16.1.1 Showing the chamber’s MAC address

Path: **Normal display**    **Chamber info**         **Ethernet**  **MAC address**

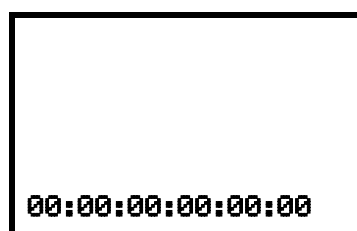

Display of the MAC address (example)

Toggle forth and back with the **Back button** and the **OK button**.

With the **arrow-down button** you can now change to the next parameter (IP address).

With the **Back button** you can go back to the “**Ethernet**” submenu and, repeatedly pressing it, to **Normal display**.



### 16.1.2 Showing the IP address

Path: **Normal display** ▾ ▾ ▾ **Chamber info**  ▾ ▾ ▾ ▾ ▾ ▾ ▾ **Ethernet**  ▾ **IP address**

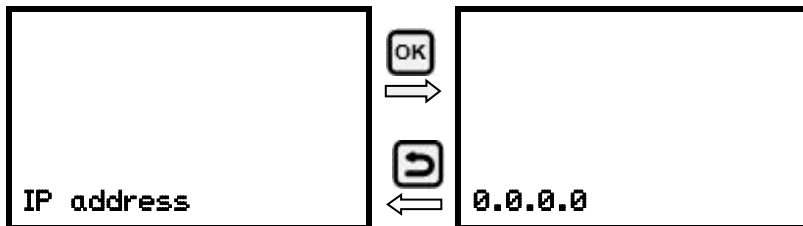

Display of the IP address (example)  
Toggle forth and back with the **Back button** and the **OK button**.

With the **arrow-down button** you can now change to the next parameter (subnet mask).

With the **Back button** you can go back to the “**Ethernet**” submenu and, repeatedly pressing it, to **Normal display**.

### 16.1.3 Showing the subnet mask

Path: **Normal display** ▾ ▾ ▾ **Chamber info**  ▾ ▾ ▾ ▾ ▾ ▾ ▾ **Ethernet**  ▾ ▾ **Subnet mask**

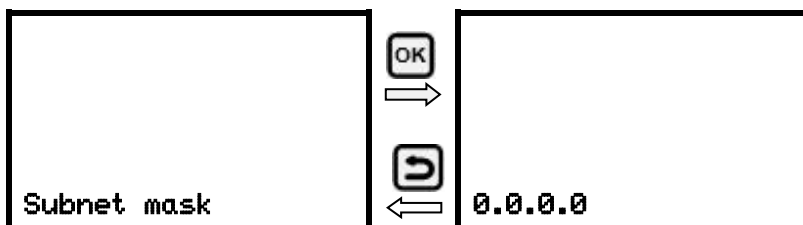

Display of the subnet mask (example)  
Toggle forth and back with the **Back button** and the **OK button**.

With the **arrow-down button** you can now change to the next parameter (standard gateway).

With the **Back button** you can go back to the “**Ethernet**” submenu and, repeatedly pressing it, to **Normal display**.

### 16.1.4 Showing the standard gateway

Path: **Normal display** ▾ ▾ ▾ **Chamber info**  ▾ ▾ ▾ ▾ ▾ ▾ ▾ **Ethernet**  ▾ ▾ ▾ **Standard gateway**

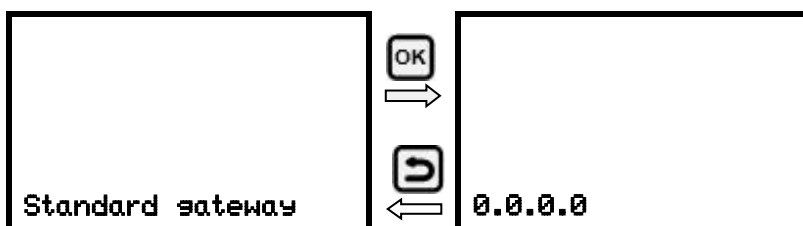

Display of the standard gateway (example)  
Toggle forth and back with the **Back button** and the **OK button**.

With the **arrow-down button** you can now change to the next parameter (DNS server address).

With the **Back button** you can go back to the “**Ethernet**” submenu and, repeatedly pressing it, to **Normal display**.

### 16.1.5 Showing the DNS server address

Path: **Normal display** ▾ ▾ ▾ **Chamber info**  ▾ ▾ ▾ ▾ ▾ ▾ ▾ **Ethernet**  ▾ ▾ ▾ ▾ ▾  
**DNS server address**



Display of the DNS server address (example)  
 Toggle forth and back with the **Back button** and the **OK button**.

With the **arrow-down button** you can now change to the next parameter (DNS chamber name).

With the **Back button** you can go back to the "Ethernet" submenu and, repeatedly pressing it, to **Normal display**.

### 16.1.6 Showing the DNS chamber name

Path: **Normal display** ▾ ▾ ▾ **Chamber info**  ▾ ▾ ▾ ▾ ▾ ▾ ▾ **Ethernet**  ▾ ▾ ▾ ▾ ▾ ▾ ▾  
**DNS chamber name**

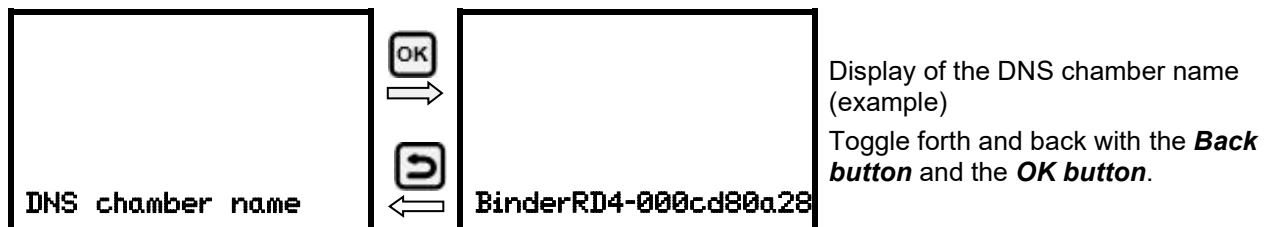

Display of the DNS chamber name (example)  
 Toggle forth and back with the **Back button** and the **OK button**.

With the **Back button** you can go back to the "Ethernet" submenu and, repeatedly pressing it, to **Normal display**.

## 16.2 Changing the configuration of the network settings

Required access level: "Admin".

The "Ethernet" submenu offers to subsequently or individually access the following settings:

- Selecting the type of assignment (automatic or manual) of the IP address, chap. 16.2.1

If automatic IP address assignment has been selected:

- Selecting the type of assignment (automatic or manual) of the DNS server address, chap. 16.2.2

If manual IP address assignment has been selected:

- Assigning the IP address, chap. 16.2.3
- Assigning the subnet mask, chap. 16.2.4
- Assigning the standard gateway, chap. 16.2.5

If manual IP address assignment or manual DNS server address assignment has been selected:

- Assigning the DNS server address, chap. 16.2.6

### 16.2.1 Selecting the type of IP address assignment (automatic / manual)

Path: **Normal display** ▾ ▾ ▾ ▾ **Settings**  **Ethernet**  **IP address assignment**

Press the **OK button** to enable the setting



Selection of the type of assignment of the IP address.

The current setting flashes. Use the **arrow buttons** to select between AUTO (automatic) and MANU (manual).

Confirm the setting with the **OK button**.

With the **arrow-down button** you can now change to the next parameter.

- If manual IP address assignment has been selected: assign the IP address (chap. 16.2.3)
- If automatic IP address assignment has been selected: select the type of assignment of the DNS server address (chap. 16.2.2).

With the **Back button** you can go back to the “**Ethernet**” submenu and, repeatedly pressing it, to **Normal display**.

### 16.2.2 Selecting the type of assignment of the DNS server address (automatic / manual)

Access to this function is possible only if automatic IP address assignment has been selected (chap. 16.2.1).

Path: **Normal display** ▾ ▾ ▾ ▾ **Settings**  **Ethernet**  **DNS server**

Press the **OK button** to enable the setting.

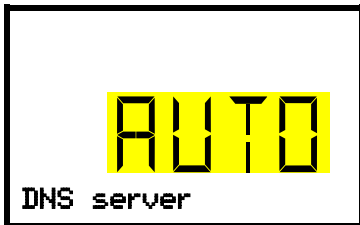

Selection of the type of assignment of the DNS server address.

The current setting flashes. Use the **arrow buttons** to select between AUTO (automatic) and MANU (manual).

Confirm the setting with the **OK button**.

If manual assignment of the DNS server address has been selected, you can now change with the **arrow-down button** to assign the DNS server address (chap. 16.2.6).

With the **Back button** you can go back to the “**Ethernet**” submenu and, repeatedly pressing it, to **Normal display**.

### 16.2.3 Assigning the IP address

Access to this function is possible only if manual IP address assignment has been selected (chap. 16.2.1)

Path: **Normal display** ▾ ▾ ▾ ▾ **Settings**  **Ethernet**  **IP address**

Press the **OK button** to enable the setting.

The IP address entry is done in four steps, corresponding to the number sections: (1).(2).(3).(4)

Principle of entry:

- Use the **OK button** to select the desired section of the IP address 1/4, 2/4, 3/4, 4/4 in the upper display line
- Use the **Arrow buttons** to enter the value for the selected section of the IP address

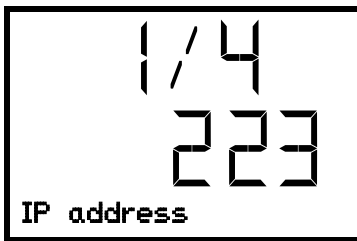

IP address assignment (sample values).

The first section of the IP address is shown. Enter the desired value with the **arrow buttons**.

Use the **OK button** to confirm the entry and proceed to the second section of the IP address.

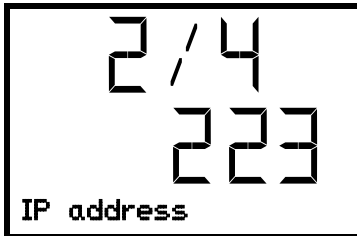

IP address assignment (sample values).

The second section of the IP address is shown. Enter the desired value with the **arrow buttons**.

Use the **OK button** to confirm the entry and proceed to the third section of the IP address.

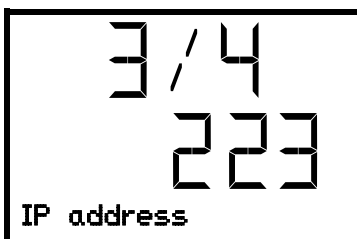

IP address assignment (sample values).

The third section of the IP address is shown. Enter the desired value with the **arrow buttons**.

Use the **OK button** to confirm the entry and proceed to the last section of the IP address.



IP address assignment (sample values).

The fourth section of the IP address is shown. Enter the desired value with the **arrow buttons**.

Confirm the setting with the **OK button**.

With the **arrow-down button** you can now change to the enter the subnet mask.

With the **Back button** you can go back to the **"Ethernet"** submenu and, repeatedly pressing it, to **Normal display**.

#### 16.2.4 Setting the subnet mask

Access to this function is possible only if manual IP address assignment has been selected (chap. 16.2.1)

Path: **Normal display**     **Settings**   **Ethernet**     **Subnet mask**

Press the **OK button** to enable the setting.

The subnet mask entry is done in four steps, corresponding to the number sections: (1).(2).(3).(4)

Principle of entry:

- Use the **OK button** to select the desired section of the subnet mask 1/4, 2/4, 3/4, 4/4 in the upper display line
- Use the **Arrow buttons** to enter the value for the selected section of the subnet mask

For details please refer to the description of the similar procedure in chap. 16.2.3 "Assigning the IP address".

With the **arrow-down button** you can now change to the enter the standard gateway.

With the **Back button** you can go back to the **"Ethernet"** submenu and, repeatedly pressing it, to **Normal display**.

## 16.2.5 Setting the standard gateway

Access to this function is possible only if manual IP address assignment has been selected (chap. 16.2.1)

Path: **Normal display**     **Settings**   **Ethernet**      **Standard gateway**

Press the **OK button** to enable the setting.

The standard gateway entry is done in four steps, corresponding to the number sections: (1).(2).(3).(4)

Principle of entry:

- Use the **OK button** to select the desired section of the standard gateway 1/4, 2/4, 3/4, 4/4 in the upper display line
- Use the **Arrow buttons** to enter the value for the selected section of the standard gateway
- For details please refer to the description of the similar procedure in chap. 16.2.3 “Assigning the IP address”.

With the **arrow-down button** you can now change to the assign the DNS server address.

With the **Back button** you can go back to the “**Ethernet**” submenu and, repeatedly pressing it, to **Normal display**.

## 16.2.6 Assigning the DNS server address

Access to this function is possible if manual IP address assignment (chap. 16.2.1) or manual DNS server address assignment (chap. 16.2.2) has been selected.

With manual IP address assignment:

Path: **Normal display**     **Settings**   **Ethernet**      **DNS server address**

With manual DNS server address assignment:

Path: **Normal display**     **Settings**   **Ethernet**    **DNS server address**

Press the **OK button** to enable the setting.

The DNS server address entry is done in four steps, corresponding to the number sections: (1).(2).(3).(4)

Principle of entry:

- Use the **OK button** to select the desired section of the DNS server address 1/4, 2/4, 3/4, 4/4 in the upper display line
- Use the **Arrow buttons** to enter the value for the selected section of the DNS server address
- For details please refer to the description of the similar procedure in chap. 16.2.3 “Assigning the IP address”.

With the **Back button** you can go back to the “**Ethernet**” submenu and, repeatedly pressing it, to **Normal display**.

## 17. Data recorder

An internal data recorder saves chamber data and events in three data sets.

With the export function “Export recorder data” (chap. 18.3) you can save the three data sets via the USB interface to USB stick. They are issued in the selected language as a spreadsheet with the file extension “.csv” and can be further processed in the desired program. The data is unencrypted. Always the entire data memory is read out.

## 17.1 Recorded data

All data is given out in tabular form. The headlines of the values “number”, “date”, and “time” are given out in the selected language, all other information in English.

- **Chamber data for the user “DL1”**

Tabular representation of the actual temperature values together with the date and time, according to the set storage rate (chap. 17.3). Temperature values are always given out in °C.

- **Chamber data for BINDER Service “DL2”**

This data is intended for use by BINDER Service. It also contains information from the self-test function. The storage rate is fix (1 minute). Temperature values are always given out in °C.

- **Event list**

Messages regarding the controller and data memory as well as the alarm messages together with the date and time:

- Firmware update done
- “New config (USB)”: New configuration uploaded via USB
- “Data recorder cleared”: Data recorder and event list deleted via setup program
- Other event messages according to existing alarms
- The moment of switching the alarm state on and off is indicated under “On/Off”.

## 17.2 Storage capacity

The storage capacity of the data recorder depends on the number of entries.

- DL1 = 110.000 entries (equaling 76 days with a storage rate of 1 minute, setting see chap. 17.3)
- DL2 = 27.000 entries (equaling 18 days with a fix storage rate of 1 minute)
- Event list: 200 events

The shorter the set storage rate, the closer are the stored measuring points, the more precise, but also shorter is the documented period.

Once the storage capacity of the data recorder is reached, overwriting of the oldest values begins

## 17.3 Setting the storage rate for the “DL1” recorder data

Required access level: “Admin”.

Path: **Normal display**     **Settings**    **Data recorder**  **Storage interval**

Press the **OK button** to enable the setting.

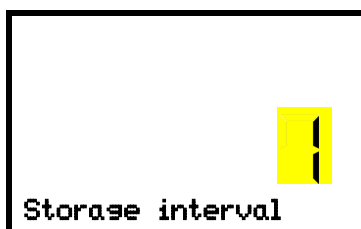

Function “Storage interval”.

The current setting flashes. Use the **arrow buttons** to enter the desired storage interval. Setting range: 1 minute to 60 minutes.

Press the **OK button** to confirm the setting.

With the **Back button** you can go back to the “**Data recorder**” submenu and, repeatedly pressing it, to **Normal display**.

## 17.4 Deleting the data recorder

When importing a configuration via USB stick and when loading a new firmware version by BINDER service, the entire data memory is deleted.

BINDER service can also install the configuration by means of a setup program without deleting the data.

Regardless of this, BINDER Service can delete the data via a setup program.

Loading a new configuration via USB-Stick leads to deleting the data recorder.

	NOTICE
	<p><b>Danger of information loss when loading a new configuration.</b>  <b>Information loss.</b></p> <ul style="list-style-type: none"> <li>➤ Backup data prior to loading a new configuration.</li> </ul>

## 18. USB menu: Data transfer via USB interface

A USB interface for data transfer via USB stick is located in the instrument box (the second micro USB interface is only used by the manufacturer).

The controller offers an import function and three export functions through the USB interface:

### Import function (chap. 18.2):

- Configuration data in file "KONF380.set"

### Export functions (chap. 18.3):

- Configuration data in file "KONF380.set"
- Recorder data
  - DL1 (chamber data for the user): "DL1\_[MAC address of the chamber].csv"
  - DL2 (chamber data for BINDER Service): "DL2\_[MAC address of the chamber].csv"
  - Event list: "EvList\_[MAC address of the chamber].csv"

For detailed information on the file content see chap. 17.1.

- Service data

The "Service" folder is created on the USB stick and can be sent to BINDER Service. In addition to the configuration and recorder data, it contains further service-relevant information.

### 18.1 Connecting the USB stick

Connect the USB stick to the interface located in the triangular instrument panel.

	<p>Connect only USB sticks to the USB interface.          The USB stick must be formatted with FAT32 and have at least 8GB of memory.</p>
---	---

After inserting the USB stick, the initial function "Import configuration" is displayed.

As long as the USB stick is connected, only the functions for data transfer are available. Other controller functions are only available after removing the USB stick.

## 18.2 Import function

Required access level: "Admin".



Function "Import configuration".

To import configuration data from the USB stick, press the **OK button**.

With the **arrow-down button** you can now change to the setting of the "Export configuration" function.

## 18.3 Export functions

Required access level: any user



Function "Export configuration".

To write the configuration data from the controller to the USB stick, press the **OK button**.

With the **arrow-down button** you can now change to the next function.



Function "Export recorder data".

To write the recorder data from the controller to the USB stick, press the **OK button**.

With the **arrow-down button** you can now change to the next function.



Function "Export service data".

To write the chamber data from the controller to the USB stick, press the **OK button**.

## 18.4 Ongoing data transfer

A moving arrow symbol indicates the progress of the data transfer.

Example:



Data recording is running.

Attention! Danger of data loss! Do not disconnect the USB stick from the device during ongoing data transfer!

After successful transfer, the controller shows again the initial function "Import configuration".



## 18.5 Error during data transmission

In the event of an error, the message ERR (error) is displayed.



Read error (example).

## 18.6 Removing the USB stick

Logging off the USB stick is not possible / required.

Be sure that no data recording is running (chap. 18.4).

After removing the USB stick, the controller is back in the same menu as before when connecting the USB stick.

## 19. Options

### 19.1 APT-COM™ 4 Multi Management Software (option)

The chamber is regularly equipped with an Ethernet interface (6) that can connect the BINDER APT-COM™ 4 Multi Management Software. The MAC Address is indicated in the “Ethernet” controller menu (chap. 16.1.1). The actual temperature values are given at adjustable intervals. Programming can be performed graphically via PC. Up to 100 chambers can be cross-linked. For further information please refer to the APT-COM™ 4 operating manual.

There are three variants available:

- APT-COM™ 4 BASIC-Edition – for simple recording and documentation requirements with up to 5 networked chambers.
- APT-COM™ 4 PROFESSIONAL-Edition – including scope of BASIC-Edition, additionally with convenient chamber and user management, suitable for networking up to 100 chambers.
- APT-COM™ 4 GLP-Edition – including scope of PROFESSIONAL-Edition, additionally suitable for working under GLP-compliant conditions. The measured values are documented in a tamper-proof manner in accordance with the requirements of the FDA guideline 21CFR11.

### 19.2 Object temperature display with flexible Pt100 temperature sensor (option)

With this option an additional flexible temperature sensor Pt100 measures the chamber temperature or the temperature of the charging material which is shown on the controller. The sensor-top protective tube of the flexible Pt100 can be immersed into liquid substances.

The object temperature display enables the determination of the actual temperature of the charging material during the whole process.

In Normal display, the current actual values and the measures object temperature values are shown alternately:

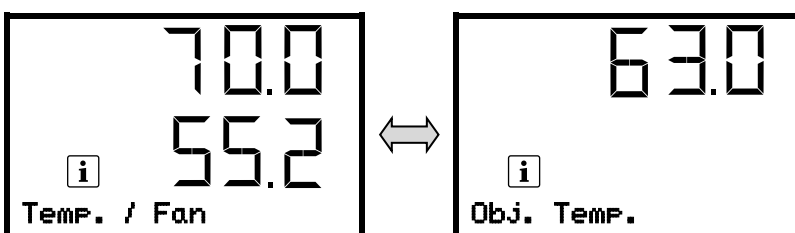

**Technical data of the Pt100 sensor:**

- Three-wire technique
- Class B (DIN EN 60751)
- Temperature range up to 320 °C / 608 °F
- Stainless steel protective tube 45 mm length, material no. 1.4501

**19.3 Analog output for temperature (option)**

With this option the chamber is equipped with an analog output 4-20 mA for temperature. This output permits transmitting data to external data registration systems or devices.

The connection is realized as a 9-poles SUB-D socket “Analog output” (7) as follows:

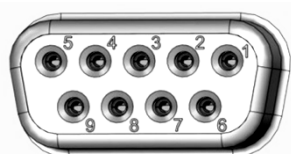

Analog output 4-20 mA DC  
 PIN 6: Temperature –  
 PIN 7: Temperature +  
**Temperature range:** 0 °C up to +300 °C

Figure 14: Pin configuration of the SUB-D socket “Analog output” (7) for the analog outputs option

**19.4 HEPA fresh air filter (option)**

With this option, the introduced fresh air is cleaned by means of a high efficiency submicron particulate air filter type HEPA class H 14 (acc. to DIN EN 1822:2009), 99,995 % with 0,3 µm. Replace the filter insert, if necessary, by removing the metal cover of the filter at the left side of the chamber (Art. No. 6014-0003).

**19.5 Mostly gas-tight version (option)**

With this option the chamber is additionally sealed, so the loss when introducing gases is decreased. The chamber is not completely gas-tight, so it is impossible to establish overpressure. The sealing diminishes the release of vapors via the housing that may be set free from the charging material when heated. Carrying-off via the regular evacuation duct, e.g. into a waste air installation, is likely to further reduce emissions.

	<p>The chamber is not completely gas-tight. Gases from inside the chamber can escape into the surrounding atmosphere.</p> <p>Observe the occupational exposure limit OEL for the released substance set by the national authorities (formerly maximum permitted workplace concentration). Respect the relevant regulations.</p> <p>Any harmful gas that might escape has to be led out via good room ventilation or a suitable exhaust system. Place the chamber, if necessary, below a gas vent.</p>
---	---

The air flap does not close the exhaust duct completely. The delivered plug serves to avoid emerging of vapors or loss of introduced inert gas, if any, via the exhaust duct. Due to special demands of heat resistance, use the delivered plug only.

	<b>NOTICE</b>
	<p><b>Danger of inflammation when using an inappropriate plug.</b></p> <p><b>Damage to the chamber and its surroundings.</b></p> <p>➤ Use ONLY the supplied plug to close the exhaust duct.</p>

For drying purpose, please remove the plug in order to permit dissipation of the generated vapor, which would lead to condensation in the inner chamber.

## 19.6 Inert gas connection with mostly gas-tight version (option)

With this option the chamber is additionally sealed, so the loss when introducing inert gases is decreased. For details on the mostly gas-tight version please refer to chap. 19.6.

The chamber is equipped with two ports for inert gas (nitrogen or noble gases).

The ports are located **on the top panel in the middle (A)** and **on the chamber rear at the bottom left (seen from the back) (B)**. Each of these ports can be used as inlet or outlet, depending on the nature of the inert gas:

- lighter gas (nitrogen, helium): lower port as inlet
- heavy gas (e.g. argon): upper port as inlet

This distinction is important when operating with a reduced fan speed.

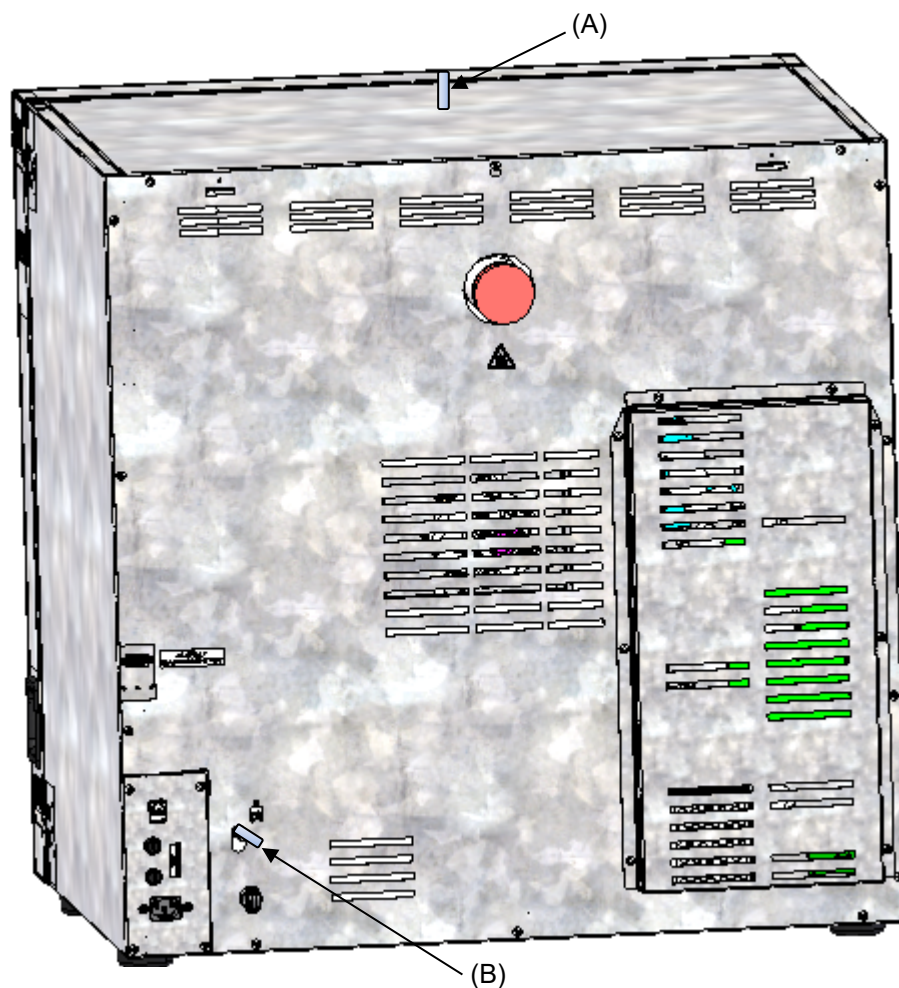



Figure 15: Position of the inert gas ports on the top panel (A) and on the chamber rear (B)

## Connection

Observe the legal requirements and relevant standards and regulations for the safe handling of gas cylinders and inert gases.

	<p>General information for safe handling of gas cylinders:</p> <ul style="list-style-type: none"> <li>• Store and use gas cylinders only in well ventilated areas.</li> <li>• Open the gas cylinder valve slowly to avoid pressure surges</li> <li>• Secure gas cylinders during storage and use against falling (chaining).</li> <li>• Transport gas cylinders with a cylinder cart, do not carry, roll, or throw them</li> <li>• Always close the valve even with apparently empty cylinders; screw on the cap when not in use. Return gas cylinders with the valve closed</li> <li>• Do not open gas cylinders by force. Mark them when damaged</li> <li>• Observe relevant regulations for dealing with gas cylinders.</li> </ul>
---	---



Connect a flexible gas tube to the gas hose connection adapter (A) or (B) (outer diameter 10mm), which is used for gas inlet, and secure it with hose clamps (hose and hose clamps are not enclosed). There is a constant gas flow after establishing the connection.

	<p>After connecting the gas cylinder, check all gas connections for leaks (e.g. with leak spray or diluted soap solution).</p>
---	--

Use a pressure reducer and make sure to avoid any excessive outlet pressure when connecting the gas hose to the chamber.

	<p>The chamber is not entirely gas-tight. Inert gases from inside the chamber can escape into the surrounding atmosphere.</p>
---	---

Inert gases in high concentrations is hazardous to health. They are colorless and almost odorless and therefore practically imperceptible. Inhalation of inert gases can cause drowsiness up to respiratory arrest. When the O<sub>2</sub> content of the air decreases below 18%, there is risk of death from lack of oxygen. Any gas that might escape has to be led out via good room ventilation or a suitable exhaust system.

	 <b>DANGER</b>
	<p><b>Risk of suffocation through high concentration of inert gas.</b>  <b>Death by suffocation.</b></p> <ul style="list-style-type: none"> <li>⊘ Do NOT set up chambers in non-ventilated recesses.</li> <li>➤ Ensure technical ventilation measures.</li> <li>➤ Observe the relevant regulations for handling inert gases.</li> <li>➤ Close the gas supply when decommissioning the chamber.</li> </ul>

	<p>Inert gases, which are heavier than air, may accumulate in low-lying areas of the installation site.</p>
---	---

The “Mostly gas-tight version” reduces the loss of gas.

### Setting (sample values):

If you want to flush the chamber with an air exchange rate of 1 per hour, set the flow rate on the pressure reducer according to the interior volume.

Chamber with 56 l internal volume: The flow rate corresponding to 56 l / h is 0.9 l / min.

Chamber with 115 l internal volume: The flow rate corresponding to 115 l / h is 1.9 l / min.

Chamber with 260 l internal volume: The flow rate corresponding to 260 l / h is 4.3 l / min.

The air flap does not close the exhaust duct completely. The delivered plug serves to avoid loss of introduced inert gas via the exhaust duct. Due to special demands of heat resistance, use the delivered plug only.



	NOTICE
	<p><b>Danger of inflammation when using an inappropriate plug.</b>  <b>Damage to the chamber and its surroundings.</b></p> <ul style="list-style-type: none"> <li>➤ Use ONLY the supplied plug to close the exhaust duct.</li> </ul>

For drying purpose, please remove the plug in order to permit dissipation of the generated vapor, which would lead to condensation in the inner chamber.

## 20. Cleaning and decontamination

Clean the chamber after each use in order to prevent potential corrosion damage by ingredients of the loading material.

Prior to renewed startup, allow the chamber to completely dry after all cleaning and decontamination measures.

	 <b>DANGER</b>
	<p><b>Electrical hazard by water entering the chamber.</b>  <b>Deadly electric shock.</b></p> <ul style="list-style-type: none"> <li>⊘ Do NOT spill water or cleaning agents over the inner and outer chamber surfaces.</li> <li>⊘ Do NOT put ANY cleaning aids (cloth or brush) into slots or openings on the chamber.</li> <li>➤ Before cleaning, turn off the chamber with the on/off switch (4) or main power switch (11) and disconnect the power plug. Let the chamber cool down to ambient temperature.</li> <li>➤ Completely dry the chamber before turning it on again.</li> </ul>

### 20.1 Cleaning

Disconnect the chamber from the power supply before cleaning. Disconnect the power plug.

	<p>The interior of the chamber must be kept clean. Thoroughly remove any residues of the charging material</p>
---	--

Wipe the surfaces with a moistened towel. In addition, you can use the following cleaning agents:

Exterior surfaces inner chamber racks door gaskets	Standard commercial cleaning detergents free from acid or halides. Alcohol-based solutions. We recommend using the neutral cleaning agent Art. No. 1002-0016.
Instrument panel	Standard commercial cleaning detergents free from acid or halides. We recommend using the neutral cleaning agent Art. No. 1002-0016.
Zinc coated hinge parts rear chamber wall	Standard commercial cleaning detergents free from acid or halides. Do NOT use a neutral cleaning agent on zinc coated surfaces.

Do not use cleaning agents that may cause a hazard due to reaction with components of the device or the charging material. If there is doubt regarding the suitability of cleaning products, please contact BINDER service.

	<p>We recommend using the neutral cleaning agent Art. No. 1002-0016 for a thorough cleaning. Any corrosive damage that may arise following use of other cleaning agents is excluded from liability by BINDER GmbH.</p> <p>Any corrosive damage caused by a lack of cleaning, is excluded from liability by BINDER GmbH.</p>
---	---

	<b>NOTICE</b>
	<p><b>Danger of corrosion by using unsuitable cleaners.</b>  <b>Damage to the chamber.</b></p> <ul style="list-style-type: none"> <li>∅ Do NOT use acidic or chlorine cleaning detergents.</li> <li>∅ Do NOT use a neutral cleaning agent on other kind of surfaces e.g., the zinc coated hinge parts or the rear chamber wall.</li> </ul>

	<p>For surface protection, perform cleaning as quickly as possible. After cleaning completely remove cleaning agents from the surfaces with a moistened towel. Let the chamber dry.</p>
---	---



	<p>Soapsuds may contain chlorides and must therefore NOT be used for cleaning.</p>
---	--

	<p>With every decontamination method, always use adequate personal safety controls.</p>
--	---

Following cleaning, leave the chamber door open or remove the plugs of the optional access port.

	<p>The neutral cleaning agent may cause health problems in contact with skin and if ingested. Follow the operating instructions and safety hints labeled on the bottle of the neutral cleaning agent.</p>
---	---

Recommended precautions: To protect the eyes use sealed protective goggles. Wear gloves. Suitable protective gloves in full contact with media: butyl or nitrile rubber, penetration time >480 minutes.

	<p style="text-align: center;"> <b>CAUTION</b></p> <p><b>Danger of chemical burns through contact with skin or ingestion of the neutral cleaning agent.</b>  <b>Skin and eye damage. Environmental damage.</b></p> <ul style="list-style-type: none"> <li>∅ Do not ingest the neutral cleaning agent. Keep it away from food and beverages.</li> <li>∅ Do NOT empty the neutral cleaning agent into drains.</li> <li>➤ Wear protective gloves and goggles.</li> <li>➤ Avoid skin contact with the neutral cleaning agent.</li> </ul>
---	---



## 20.2 Decontamination / chemical disinfection

The operator must ensure that proper decontamination is performed in case a contamination of the chamber by hazardous substances has occurred.

Disconnect the chamber from the power supply prior to decontamination. Pull the power plug.

Do not use decontamination agents that may cause a hazard due to reaction with components of the device or the charging material. If there is doubt regarding the suitability of cleaning products, please contact BINDER service.

You can use the following disinfectants:

Inner chamber	Standard commercial surface disinfectants free from acid or halides. Alcohol-based solutions. We recommend using the disinfectant spray Art. No. 1002-0022.
---------------	---

	For chemical disinfection, we recommend using the disinfectant spray Art. No. 1002-0022. Any corrosive damage that may arise following use of other disinfectants is excluded from liability by BINDER GmbH.
---	--

	With every decontamination / disinfection method, always use adequate personal safety controls.
---	---



In case of impurity of the interior with biological or chemical hazardous material, there are three possible procedures depending on the type of contamination and of the charging material.

1. The drying and heating ovens FP can be hot air sterilized at e.g., 190 °C / 374 °F for at least 30 minutes. All inflammable goods must be removed from the interior before.
2. Spray the inner chamber with an appropriate disinfectant.

Before start-up, the chamber must be absolute dry and ventilated, because explosive gases may form during the decontamination process.

	In case of eye contact, the disinfectant spray may cause eye damage due to chemical burns. Follow the operating instructions and safety hints labeled on the bottle of the disinfectant spray.
---	--

Recommended precautions: To protect the eyes use sealed protective goggles.

	 <b>CAUTION</b>
	<p><b>Danger of chemical burns through eye contact with the disinfectant spray.</b></p> <p><b>Eye damage. Environmental damage</b></p> <ul style="list-style-type: none"> <li>⊘ Do NOT empty the disinfectant into drains.</li> <li>➤ Wear protective goggles.</li> </ul>

	After using the disinfectant spray, allow the chamber to dry thoroughly, and aerate it sufficiently.
---	--

## 21. Maintenance and service, troubleshooting, repair, testing

### 21.1 General information, personnel qualification

- **Maintenance**

See chap. 21.2.

- **Simple troubleshooting**

Chap. 21.3 describes troubleshooting by operating personnel. It does not require technical intervention into the chamber, nor disassembly of chamber parts.

For personnel requirements please refer to chap. 1.1.

- **Detailed troubleshooting**

If errors cannot be identified with simple troubleshooting, further troubleshooting must be performed by BINDER Service or by BINDER qualified service partners or technicians, in accordance with the description in the Service Manual.

For personnel requirements please refer to the Service Manual.

- **Repair**

Repair of the chamber can be performed by BINDER Service or by BINDER qualified service partners or technicians, in accordance with the description in the Service Manual.



After maintenance, the chamber must be tested prior to resuming operation.

- **Electrical testing**

To prevent the risk of electrical shock from the electrical equipment of the chamber, an annual repeat inspection as well as a test prior to initial startup and prior to resuming operation after maintenance or repair, are required. This test must meet the requirements of the competent public authorities. We recommend testing under EN 50678/VDE 0701 and EN 50699/VDE 0702 in accordance with the details in the Service Manual.

For personnel requirements please refer to the Service Manual.

### 21.2 Maintenance intervals, service

 	 <b>DANGER</b>
	<p><b>Electrical hazard during live maintenance work.</b>  <b>Deadly electric shock.</b></p> <ul style="list-style-type: none"> <li>Ø The chamber must NOT become wet during operation or maintenance works.</li> <li>Ø Do NOT remove the rear panel of the chamber.</li> <li>➤ Disconnect the chamber before conducting maintenance work. Turn off the chamber with the on/off switch (4) or main power switch (11) and pull the power plug.</li> <li>➤ Make sure that all maintenance work will be conducted by licensed electricians or experts authorized by BINDER.</li> </ul>

Ensure regular maintenance work is performed at least once a year.

	The warranty becomes void if maintenance work is conducted by non-authorized personnel.
---	---

	Replace the door gasket only when cold. Otherwise, the door gasket may become damaged.
---	--



We recommend taking out a maintenance agreement. Please consult BINDER Service.

BINDER telephone hotline:	+49 (0) 7462 2005 555
BINDER fax hotline:	+49 (0) 7462 2005 93555
BINDER e-mail hotline:	customerservice@binder-world.com
BINDER service hotline USA:	+1 866 885 9794 or +1 631 224 4340 x3 (toll-free in the USA)
BINDER service hotline Asia Pacific:	+852 390 705 04 or +852 390 705 03
BINDER Internet website	http://www.binder-world.com
BINDER address	BINDER GmbH, post office box 102, D-78502 Tuttlingen

International customers, please contact your local BINDER distributor.

## 21.3 Simple troubleshooting

Defects and shortcomings can compromise the operational safety of the chamber and can lead to risks and damage to equipment and persons. If there is a technical fault or shortcoming, take the chamber out of operation and inform BINDER Service. If you are not sure whether there is a technical fault, proceed according to the following list. If you cannot clearly identify an error or there is a technical fault, please contact BINDER Service.



Only qualified service personnel authorized by BINDER must perform repair. Repaired chambers must comply with the BINDER quality standards.

Fault description	Possible cause	Required measures
<b>General</b>		
Chamber without function.	No power supply.	Check connection to power supply. Check whether the chamber is turned on with the On/Off switch (4) or main power switch (11).
	Wrong voltage.	Check power supply for correct voltage (chap. 4.1).
	Chamber fuse has responded.	Check chamber fuse and replace it if appropriate (chap. 23.3). If it responds again, contact BINDER service.
	Defective controller.	Contact BINDER service.
	Overtemperature protective device class 1 has turned off the chamber.	Disconnect the chamber from the power supply for at least 10 seconds and let it cool down. If the device responds again, contact BINDER service.
<b>Temperature</b>		
Set-point temperature is not reached after specified time.	Chamber door not properly closed.	Completely close chamber door.
	Defective door gasket.	Replace door gasket,
	Controller not adjusted.	Calibrate and adjust controller.
	Wrong voltage.	Check the power supply for correct voltage (chap. 4.1).
Chamber heating permanently, set-point not held.	Defective controller.	Contact BINDER service.
	Defective Pt 100 sensor.	
	Defective semiconductor relay.	
	Controller not adjusted.	Calibrate and adjust controller.

Fault description	Possible cause	Required measures
<b>Temperature (continued)</b>		
Chamber doesn't heat up. Heating icon is displayed.	Defective heating element.	Contact BINDER service.
	Defective semiconductor relay.	
Chamber doesn't heat up. No heating icon in the display. Controller display working.	Timer run off.	Re-program the timer or turn it off.
	Defective semiconductor relay.	Contact BINDER service.
	Defective controller.	
Chamber doesn't heat up. Alarm message "Overtemperature" is displayed.	Overtemperature protective device class 1 (thermal switch) activated.	Proceed as described in chap. 11.1. If appropriate, contact BINDER service.
Chamber doesn't heat up. Alarm message "Safety contr. class 3.1" is displayed.	Safety controller class 3.1 has responded.	Check the settings of the temperature set-point and of the safety device class 3.1 (chap. 11.2).
	Safety controller defective.	Contact BINDER service.
Chamber doesn't heat up. Alarm message "Safety contr. class 2" is displayed.	Safety device class 2 has turned off the chamber.	Let cool down the chamber. Check the settings of the temperature set-point and of the safety device class 2 (chap. 11.2). If appropriate, select suitable limit value.
	Safety controller defective.	Contact BINDER service.
Deviations from the indicated heating-up times.	Chamber fully loaded.	Load the chamber less or consider longer heating-up times.
<b>Controller</b>		
Alarm message "Safety controller sensor" is displayed.	Safety controller temperature sensor defective.	Contact BINDER service.
Alarm message "Sensor defective!" is displayed.	Regular temperature sensor defective. The Failsafe temperature sensor takes over the measurement.	Chamber operation can be continued for the time being. Contact BINDER service for sensor replacement.
Actual temperature value display shows " _ _ _ _ "	Regular temperature <u>and</u> Failsafe temperature sensor defective.	Contact BINDER service.
Message „1999" in the controller display	Sensor rupture between sensor and controller.	Contact BINDER service.
<b>Miscellaneous</b>		
The fan doesn't turn or turns too slowly.	Fan speed set too low	Set fan speed to 100%
	Defective fan.	Contact BINDER service.

## 21.4 Sending the chamber back to BINDER GmbH

If you return a BINDER product to us for repair or any other reason, we will only accept the product upon presentation of an **authorization number** (RMA number) that has previously been issued to you. An authorization number will be issued after receiving your complaint either in writing or by telephone **prior** to your sending the BINDER product back to us. The authorization number will be issued following receipt of the information below:

- BINDER product type and serial number
- Date of purchase
- Name and address of the dealer from which you bought the BINDER product
- Exact description of the defect or fault
- Complete address, contact person and availability of that person
- Exact location of the BINDER product in your facility
- A contamination clearance certificate (chap. 25) must be faxed in advance

The authorization number must be applied to the packaging in such a way that it can be easily recognized or be recorded clearly in the delivery documents.



For safety reasons we cannot accept a chamber delivery if it does not carry an authorization number.

**Return address:** BINDER GmbH, Abteilung Service  
Gänsäcker 16, 78502 Tuttlingen, Germany

## 22. Disposal

### 22.1 Disposal of the transport packing



Packing element	Material	Disposal
Straps to fix packing on pallet	Plastic	Plastic recycling
Wooden transport box (option) with metal screws	Non-wood (compressed match-wood, IPPC standard)	Wood recycling
	Metal	Metal recycling
Pallet (from size 115 on)	Solid wood (IPPC standard)	Wood recycling
Transport box with metal clamps	Cardboard	Paper recycling
	Metal	Metal recycling
Top cover (size 720)	Cardboard	Paper recycling
Edge protection	Styropor® or PE foam	Plastic recycling
Protection of doors and racks	PE foam	Plastic recycling
Bag for operating manual	PE foil	Plastic recycling
Insulating air cushion foil (packing of optional accessories)	PE foil	Plastic recycling

If recycling is not possible, all packing parts can also be disposed of with normal waste.

### 22.2 Decommissioning

- Turn off the chambers at the On(Off switch (4) or main power switch (11).
- Disconnect the chamber from the power supply (pull the power plug).

- With option inert gas connection (chap. 19.7): Close the inert gas supply and remove the gas connection.

	 <b>DANGER</b>
	<p><b>Risk of suffocation through high concentration of inert gas.</b>  <b>Death by suffocation.</b></p> <ul style="list-style-type: none"> <li>➤ Observe the relevant regulations for handling inert gases.</li> <li>➤ Close the gas supply when decommissioning the chamber.</li> </ul>

- Temporal decommissioning: See indications for appropriate storage, chap. 3.3.
- Final decommissioning: Dispose of the chamber as described in chap. 22.3 to 22.5.

### 22.3 Disposal of the chamber in the Federal Republic of Germany

According to Annex I of Directive 2012/19/EU of the European Parliament and of the Council on waste electrical and electronic equipment (WEEE), BINDER devices are classified as “monitoring and control instruments” (category 9) only intended for professional use“. They must not be disposed of at public collecting points.

The chambers bear the symbol for the marking of electrical and electronic equipment manufactured / placed on the market in the EC after 13 August 2005 and be disposed of in separate collection according to Directive 2012/19/EU on waste electrical and electronic equipment (WEEE) and German national law for electrical and electronic equipment (Elektro- und Elektronikgerätegesetz, ElektroG). WEEE marking: crossed-out wheeled bin with solid bar under. A significant part of the materials must be recycled in order to protect the environment.

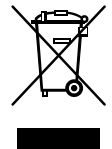

At the end of the device's service life, have the device disposed of according to the German national law for electrical and electronic equipment (Elektro- und Elektronikgerätegesetz, ElektroG from 20 October 2015, BGBl. I p. 1739) or contact BINDER service who will organize taking back and disposal of the chamber according to the German national law for electrical and electronic equipment (Elektro- und Elektronikgerätegesetz, ElektroG from 20 October 2015, BGBl. I p. 1739).

	<b>NOTICE</b>
	<p><b>Danger of violation against existing law if not disposed of properly.</b>  <b>Failure to comply with applicable law.</b></p> <ul style="list-style-type: none"> <li>⊘ Do NOT dispose of BINDER devices at public collecting points.</li> <li>➤ Have the device disposed of professionally at a recycling company which is certified according to the German national law for electrical and electronic equipment (Elektro- und Elektronikgerätegesetz, ElektroG from 20 October 2015, BGBl. I p. 1739).</li> <li style="text-align: center;"><i>or</i></li> <li>➤ Instruct BINDER Service to dispose of the device. The general terms of payment and delivery of BINDER GmbH apply, which were valid at the time of purchasing the chamber.</li> </ul>

Certified companies disassemble waste (used) BINDER equipment in primary substances for recycling according to Directive 2012/19/EU. The devices must be free from toxic, infectious or radioactive substances in order to eliminate any health hazards to the employees of the recycling companies.

	<p>Prior to handing the chamber over to a recycling company, it is the user's responsibility that it is free from toxic, infectious or radioactive substances.</p> <ul style="list-style-type: none"> <li>• Prior to disposal, clean all introduced or residual toxic substances from the chamber.</li> <li>• Prior to disposal, disinfect the chamber from all sources of infection. Be aware that sources of infection may also be located outside the inner chamber.</li> <li>• If you cannot safely remove all toxic substances and sources of infection from the chamber, dispose of it as special waste according to national law.</li> <li>• Fill out the contamination clearance certificate (chap. 25) and enclose it with the chamber.</li> </ul>
---	---

	<div style="background-color: #FFA500; text-align: center; padding: 5px;"><b>! WARNING</b></div> <p><b>Danger of intoxication and infection through contamination of the chamber with toxic, infectious or radioactive substances.</b></p> <p><b>Damages to health.</b></p> <ul style="list-style-type: none"> <li>⊘ NEVER take a chamber contaminated with toxic substances or sources of infection for recycling according to Directive 2012/19/EU.</li> <li>➤ Prior to disposal, remove all toxic substances and sources of infection from the chamber.</li> <li>➤ A chamber from which all toxic substances or sources of infection cannot be safely removed must be considered as “special” waste according to national law. Dispose of it accordingly.</li> </ul>
---	---

## 22.4 Disposal of the chamber in the member states of the EU except for the Federal Republic of Germany

According to Annex I of Directive 2012/19/EU of the European Parliament and of the Council on waste electrical and electronic equipment (WEEE), BINDER devices are classified as “monitoring and control instruments” (category 9) only intended for professional use”. They must not be disposed of at public collecting points.

The chambers bear the symbol for the marking of electrical and electronic equipment manufactured / placed on the market in the EC after 13 August 2005 and be disposed of in separate collection according to the Directive 2012/19/EU on waste electrical and electronic equipment (WEEE). WEEE marking: crossed-out wheeled bin with solid bar under.

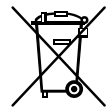

At the end of the device's service life, notify the distributor who sold you the device, who will take back and dispose of the chamber according to the Directive 2012/19/EU on waste electrical and electronic equipment (WEEE).

	<div style="background-color: #00AEEF; color: white; text-align: center; padding: 5px;"><b>NOTICE</b></div> <p><b>Danger of violation against existing law if not disposed of properly.</b></p> <p><b>Failure to comply with applicable law.</b></p> <ul style="list-style-type: none"> <li>⊘ Do NOT dispose of BINDER devices at public collecting points.</li> <li>➤ Have the device disposed of professionally at a recycling company that is certified according to conversion of the Directive 2012/19/EU into national law.</li> <li style="text-align: center;"><i>or</i></li> <li>➤ Instruct the distributor who sold you the device to dispose of it. The agreements apply that were agreed with the distributor when purchasing the chamber (e.g. his general terms of payment and delivery).</li> <li>➤ If your distributor is not able to take back and dispose of the chamber, please contact BINDER service.</li> </ul>
---	---

Certified companies disassemble waste (used) BINDER equipment in primary substances for recycling according to Directive 2012/19/EU. The devices must be free from toxic, infectious or radioactive substances in order to eliminate any health hazards to the employees of the recycling companies.

	<p>Prior to handing the chamber over to a recycling company, it is the user's responsibility that it is free from toxic, infectious or radioactive substances.</p> <ul style="list-style-type: none"> <li>• Prior to disposal, clean all introduced or residual toxic substances from the chamber.</li> <li>• Prior to disposal, disinfect the chamber from all sources of infection. Be aware that sources of infection may also be located outside the inner chamber.</li> <li>• If you cannot safely remove all sources of infection and toxic substances from the chamber, dispose of it as special waste according to national law.</li> <li>• Fill out the contamination clearance certificate (chap. 25) and enclose it with the chamber.</li> </ul>
---	---

	<b>WARNING</b>
	<p><b>Danger of intoxication and infection through contamination of the chamber with toxic, infectious or radioactive substances.</b></p> <p><b>Damages to health.</b></p> <ul style="list-style-type: none"> <li>Ø NEVER take a chamber contaminated with toxic substances or sources of infection for recycling according to Directive 2012/19/EU.</li> <li>➤ Prior to disposal, remove all toxic substances and sources of infection from the chamber.</li> <li>➤ A chamber from which all toxic substances or sources of infection cannot be safely removed must be considered as “special” waste according to national law. Dispose of it accordingly.</li> </ul>

## 22.5 Disposal of the chamber in non-member states of the EU

	<b>NOTICE</b>
	<p><b>Danger of violation against existing law if not disposed of properly.</b></p> <p><b>Failure to comply with applicable law. Alteration of the environment.</b></p> <ul style="list-style-type: none"> <li>➤ For final decommissioning and disposal of the chamber, please contact BINDER service.</li> <li>➤ Follow the statutory regulations for appropriate, environmentally friendly disposal.</li> </ul>

## 23. Technical description

### 23.1 Factory calibration and adjustment

This chamber was calibrated and adjusted in the factory. Calibration and adjustment were performed using standardized test instructions, according to the QM DIN EN ISO 9001 system applied by BINDER (certified since December 1996 by TÜV CERT). All test equipment used is subject to the administration of measurement and test equipment that is also constituent part of the BINDER QM DIN EN ISO 9001 systems. They are controlled and calibrated to a DKD-Standard at regular intervals.

### 23.2 Definition of usable volume

The usable volume illustrated below is calculated as follows:

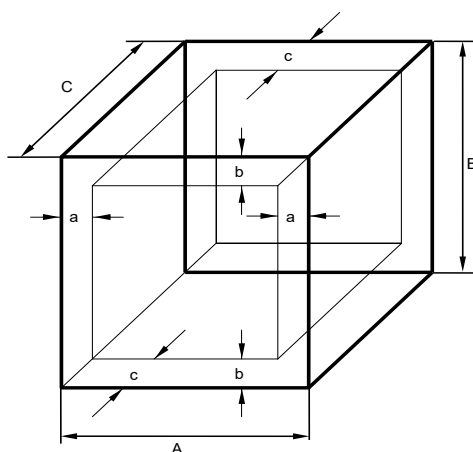

A, B, C = Internal dimensions (W, H, D)  
a, b, c = Wall clearances

$$a = 0.1 \times A$$

$$b = 0.1 \times B$$

$$c = 0.1 \times C$$

$$V_{USE} = (A - 2a) \times (B - 2b) \times (C - 2c)$$

Figure 16: Determination of the useable volume

The technical data refers to the defined usable volume.



Do NOT place samples outside this usable volume.  
 Do NOT load this volume by more than half to enable sufficient airflow inside the chamber.  
 Do NOT divide the usable volume into separate parts with large area samples.  
 Do NOT place samples too close to each other in order to permit circulation between them and thus obtain a homogenous distribution of temperature.

### 23.3 Over current protection

**Single-phase devices** are protected by one (UL chambers) or two miniature fuses against over current, accessible from the outside. The miniature fuses are located at the rear of the chamber above the power cable connection. Each fuse holder is equipped with a fuse clip 5mm x 20 mm (cUL-Version 6,3x32 mm). A fuse may be replaced only with a substitute of the same ratings. Refer to the technical data of the respective device type.

**Two-phase devices** are equipped with a resettable miniature circuit breaker (combination element).

**Three-phase devices** are equipped with an internal miniature circuit breaker.

### 23.4 FP technical data

Chamber size		FP 56	FP 115	FP 260	FP 720
<b>Exterior dimensions</b>					
Width, net	mm / inch	560 / 22.01	710 / 27.95	814 / 32.05	1165 / 45.87
Height, gross (incl. feet)	mm / inch	622 / 24.49	732 / 28.82	962 / 37.87	1589 / 62.56
Depth, net	mm / inch	596 / 23.46	636 / 25.04	786 / 30.94	816 / 32.13
Depth, gross (incl. door handle and exhaust duct)	mm / inch	648 / 25.51	690 / 27.17	840 / 33.07	870 / 34.25
Wall clearance rear (minimum)	mm / inch	160 / 6.30	160 / 6.30	160 / 6.30	160 / 6.30
Wall clearance side (minimum)	mm / inch	100 / 3.94	100 / 3.94	100 / 3.94	100 / 3.94
Exhaust duct, outer diameter	mm / inch	52 / 2.05	52 / 2.05	52 / 2.05	52 / 2.05
<b>Doors</b>					
Number of door(s)		1	1	1	2
<b>Interior dimensions</b>					
Width	mm / inch	400 / 15.75	550 / 21.65	650 / 25.59	1000 / 39.37
Height	mm / inch	440 / 17.32	550 / 21.65	780 / 30.71	1300 / 51.18
Depth	mm / inch	345 / 13.58	385 / 15.16	512 / 20.16	574 / 22.60
Interior volume	l / cu.ft.	60 / 2.12	116 / 4.10	259 / 9.15	741 / 26.17
Steam space volume	l / cu.ft.	67 / 2.37	127 / 4.49	279 / 9.85	789 / 27.86
<b>Racks</b>					
Quantity of racks (regular)		2	2	2	2
Quantity of racks (max.)		4	5	8	16
Max. load per rack (standard rack)	Kg / lbs	30 / 66	30 / 66	44 / 88	45 / 99
Max. load per rack (optional perforated shelf)	Kg / lbs	35 / 77	35 / 77	35 / 77	35 / 77
Max. load per rack (optional heavy load rack)	Kg / lbs	---	---	70 / 154	70 / 154
Permitted total load	Kg / lbs	70 / 154	150 / 330	270 / 595	315 / 694
Permitted total load, with reinforced inner chamber option	Kg / lbs	85 / 187	170 / 375	300 / 661	350 / 772
<b>Weight</b>					
Weight (empty)	Kg / lbs	41 / 90	55 / 121	82 / 181	164 / 362



Chamber size			FP 56	FP 115	FP 260	FP 720
<b>Temperature data</b>						
Temperature range	from ... degrees above ambient	°C / °F	10 / 18	10 / 18	10 / 18	12 / 21.6
	up to	°C / °F	300 / 572	300 / 572	300 / 572	300 / 572
Temperature fluctuation at 150 °C / 302 °F		± K	0.4	0.4	0.4	0.6
Temperature uniformity (variation) at 150 °C / 302 °F		± K	1.6	2.0	1.7	2.7
Heating up time to 150 °C / 302 °F		minutes	15	19	19	25
Recovery time after door was opened for 30 sec at 150 °C / 302 °F		minutes	4	5	6	6
<b>Ventilation data</b>						
Air change	at 100 °C / 212 °F	x/h	80	32	9	5
<b>Electrical data</b> (model versions FP056-230V, FP115-230V, FP260-230V, FP720-400V)						
System of protection acc. to EN 60529		IP	20	20	20	20
Nominal voltage (+/-10%)	at 50 Hz power frequency	V	230	230	230	400
	at 60 Hz power frequency	V	230	230	230	400
Current type			1N~	1N~	1N~	3N~
Nominal power		kW	1.20	1.40	2.50	4.50
Power plug of the power cable			Grounded plug			CEE 16/6H
Chamber fuse (external) 5x20 mm / 250V / time-lag (T)		A	6.3	6.3	12.5	---
Miniature circuit breaker (internal)		A	---	---	---	16
Overtemperature protective device class 1		°C	330	350	350	350
Installation category acc. to IEC 61010-1			II	II	II	II
Pollution degree acc. to IEC 61010-1			2	2	2	2
<b>Different electrical data for FP-UL constructed for the USA and Canada</b> (model versions FP056UL-120V, FP115UL-120V, FP260UL-240V)						
Nominal voltage (+/-10%)	at 60 Hz power frequency	V	120	120	240	208
Current type			1N~	1N~	2~	3N~
Nominal power		kW	1.20	1.40	2.50	4,50
Power plug of the power cable		NEMA	5-15P	5-15P	6-20P	L21-20P
Chamber fuse (external) 5x20 mm / 250V / time-lag (T)		A	12.5	12.5	---	---
Miniature circuit breaker (combination element, external)		A	---	---	16	---
Miniature circuit breaker (internal)		A	---	---	---	16
<b>Environment-specific data</b>						
Noise level (mean value)		dB (A)	43	43	43	43
Energy consumption at 150 °C / 302 °F		Wh/h	290	370	465	880

All technical data is specified for unloaded chambers with standard equipment at an ambient temperature of +22 °C +/- 3 °C / 71.6 °F +/- 5.4 °F and a power supply voltage fluctuation of +/-10%. Technical data is determined in accordance to BINDER Factory Standard Part 2:2015 and DIN 12880:2007.

**All indications are average values, typical for chambers produced in series. We reserve the right to change technical specifications at any time.**





If the chamber is fully loaded, the specified heating up times may vary according to the load.

### 23.5 Equipment and options (extract)



To operate the chamber, use only original BINDER accessories or accessories / components from third-party suppliers authorized by BINDER. The user is responsible for any risk arising from using unauthorized accessories.

Standard equipment
Microprocessor temperature controller with adjustable fan speed
Disconnectable audible over-temperature alarm
Temperature safety controller class 2 or 3.1 acc. to DIN 12880:2007, selectable
FailSafe function
Zero-voltage relay alarm contact
2 zero-voltage switching contacts, control via program controller
USB interface to read out the measured values
Communication interface Ethernet
Exhaust duct, internal diameter 50 mm / 1.97 inches, with adjustable ventilation slide
Adjustable air change by means of rear exhaust duct (50 mm)
2 racks, chrome-plated

Options / accessories
Rack, chrome-plated or stainless steel
Perforated rack, stainless steel
Heavy load rack, stainless steel
Access ports with various diameters, with silicone plug
Door lock – lockable door handle
Rubber pads for safe stacking (5 pieces)
Object temperature display with additional Pt100 temperature sensor, to display the object temperature on the controller display
Analog output 4-20 mA for temperature values (output not adjustable)
HEPA Fresh air filter at the fresh air access of the chamber, class H 14 (DIN EN 1822:2009)
Mostly gas-tight version. Option for chambers sizes 56, 115, 260. Not available in connection with the access ports option.
Inert gas connection (gas inlet and outlet), with mostly gas-tight version. Option for chambers sizes 56, 115, 260. Not available in connection with the access ports option.
FKM door gasket (temperature resistant up to 200 °C / 392 °F max.)
Measurement of air change rate acc. to ASTM D5374
Factory calibration certificate
Extension to factory calibration certificate (additional values)
Measuring protocol acc. to DIN 12880:2007
Qualification folder
Neutral cleaning agent (liquid concentrate)
Stable table on wheels with castors and locking brakes

## 23.6 Accessories and spare parts (extract)



BINDER GmbH is responsible for the safety features of the chamber only, provided skilled electricians or qualified personnel authorized by BINDER perform all maintenance and repair, and if components relating to chamber safety are replaced in the event of failure with original spare parts. The user is responsible for any risks arising from using unauthorized accessories/components.

Chamber size	56	115	260	720
Description	Art. No.			
Rack, chrome-plated	8012-2038	8012-2040	8012-2042	8012-2044
Rack, stainless steel	8012-2085	8012-2168	8012-2169	8012-2170
Perforated rack, stainless steel	8012-2175	8012-2176	8012-2177	8012-2178
Rack, heavy load, stainless steel. Load per rack max. 70 kg	---	---	8012-2184	8012-2185
Door gasket, silicone	6005-0254	6005-0255	6005-0258	6005-0260
Door gasket made of FKM, silicon-free (temperature resistant up to 200 °C / 392 °F max.)	8012-2233	8012-2234	8012-2235	8012-2236
Stable table on wheels with castors and locking brakes, W 1000 x D 800 x H 780 mm	9051-0018	9051-0018	---	---
Stabiler Tischwagen mit Rollen und Feststellbremse, W 1300 x D 800 x H 780 mm	---	---	9051-0019	---
Chamber fuse 5x20mm 250V 6,3 A time lag (T)	5006-0092	5006-0092	---	---
Chamber fuse 5x20mm 250V 8,0 A time lag (T)	---	---	5006-0093	---
Chamber fuse 5x20mm 250V 12,5 A time lag (T)	5006-0096	5006-0096	5006-0096	---

Description	Art. No.
APT-COM™ 4 BASIC-Edition	9053-0039
APT-COM™ 4 PROFESSIONAL-Edition	9053-0040
APT-COM™ 4 GLP-Edition	9053-0042
HEPA fresh air filter (replacement) class H 14 (DIN EN 1822:2009)	6014-0003
Rubber pads for safe stacking (5 pieces)	8012-0001
Neutral cleaning agent, 1 kg	1002-0016

For information on components not listed here, please contact BINDER Service.

Validation service	Art. no.
Qualification folder IQ-OQ (printed version)	7007-0001
Qualification folder IQ-OQ (digital version)	7057-0001
Qualification folder IQ-OQ-PQ (printed version)	7007-0005
Qualification folder IQ-OQ-PQ (digital version)	7057-0005
Execution of IQ-OQ	DL420300
Execution of IQ-OQ-PQ	DL440500

Calibration service	Art.-No.
Calibration of temperature including certificate (1 measuring point in center of usable volume)	8012-2227
Spatial temperature measurement including certificate (9 measuring points)	8012-2230
Spatial temperature measurement including certificate (15 to 18 measuring points)	8012-2228
Spatial temperature measurement including certificate (27 measuring points)	8012-2229
Temperature calibration certificate - extension of the measurement in the center of usable volume to include a further test temperature	8012-2231
Measurement of air ventilation acc. to ASTM D 5374, including certificate	8012-2232

### 23.7 Dimensions size 56

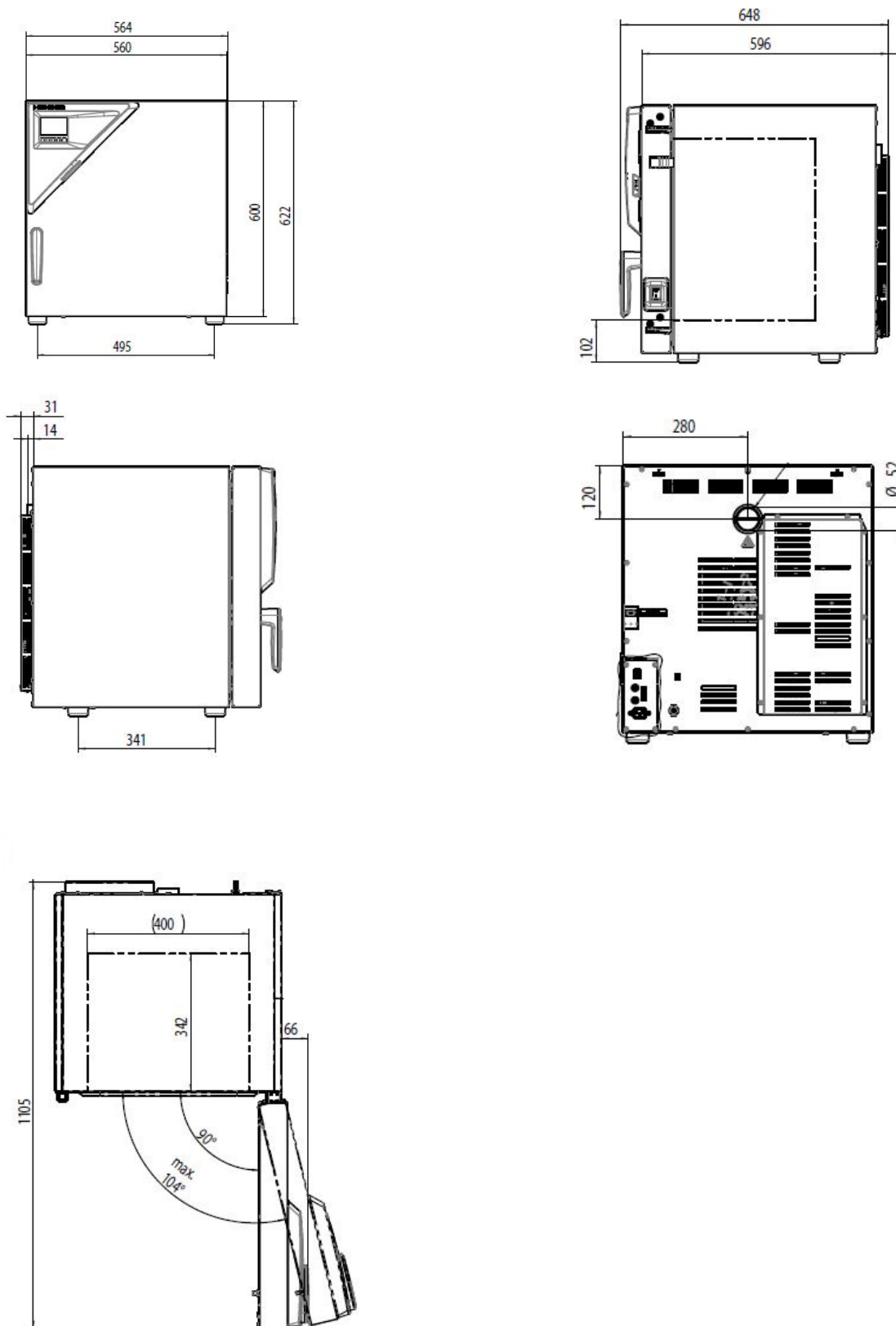

[Dimensions in mm]

### 23.8 Dimensions size 115

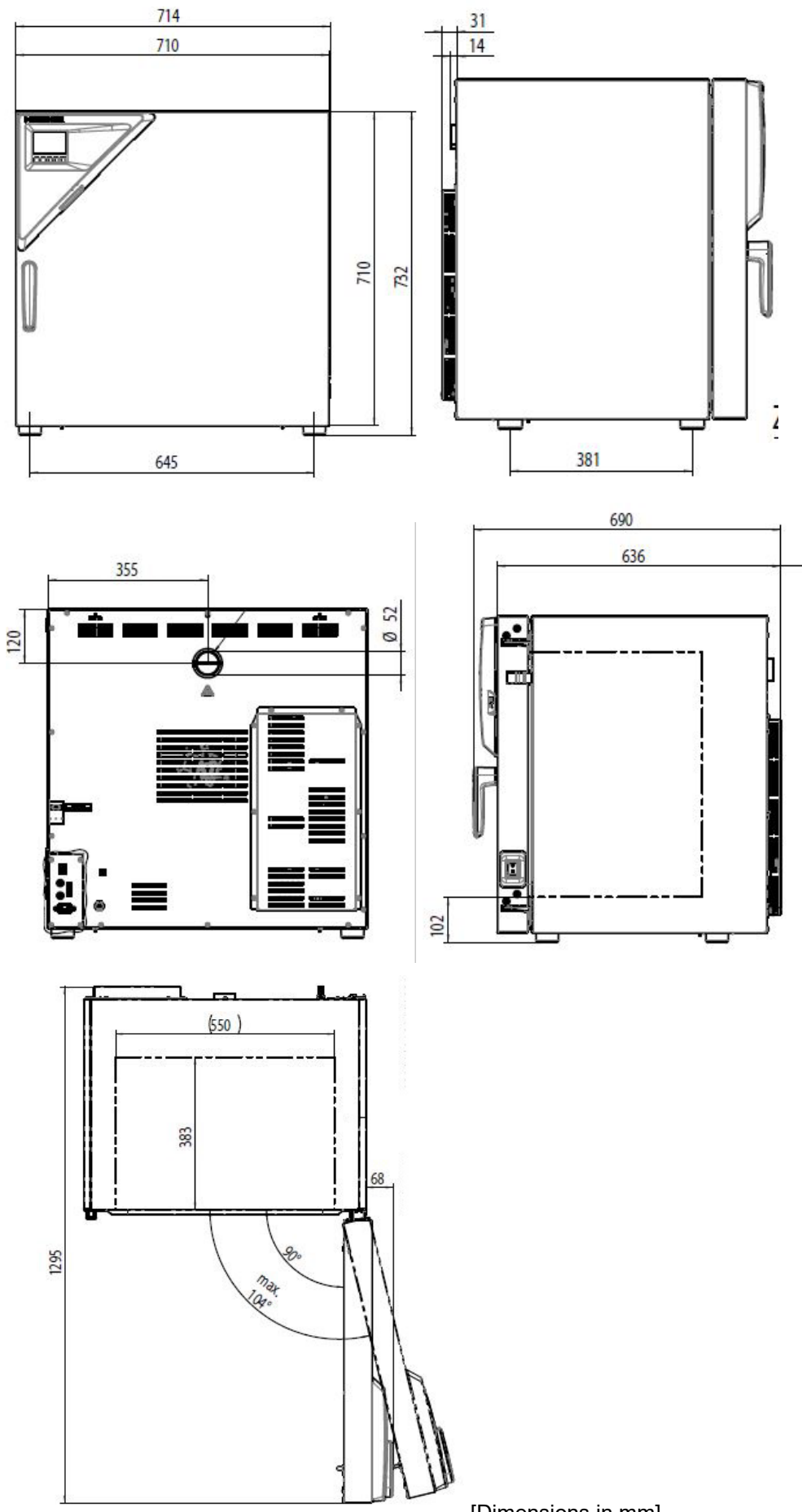

[Dimensions in mm]

### 23.9 Dimensions size 260

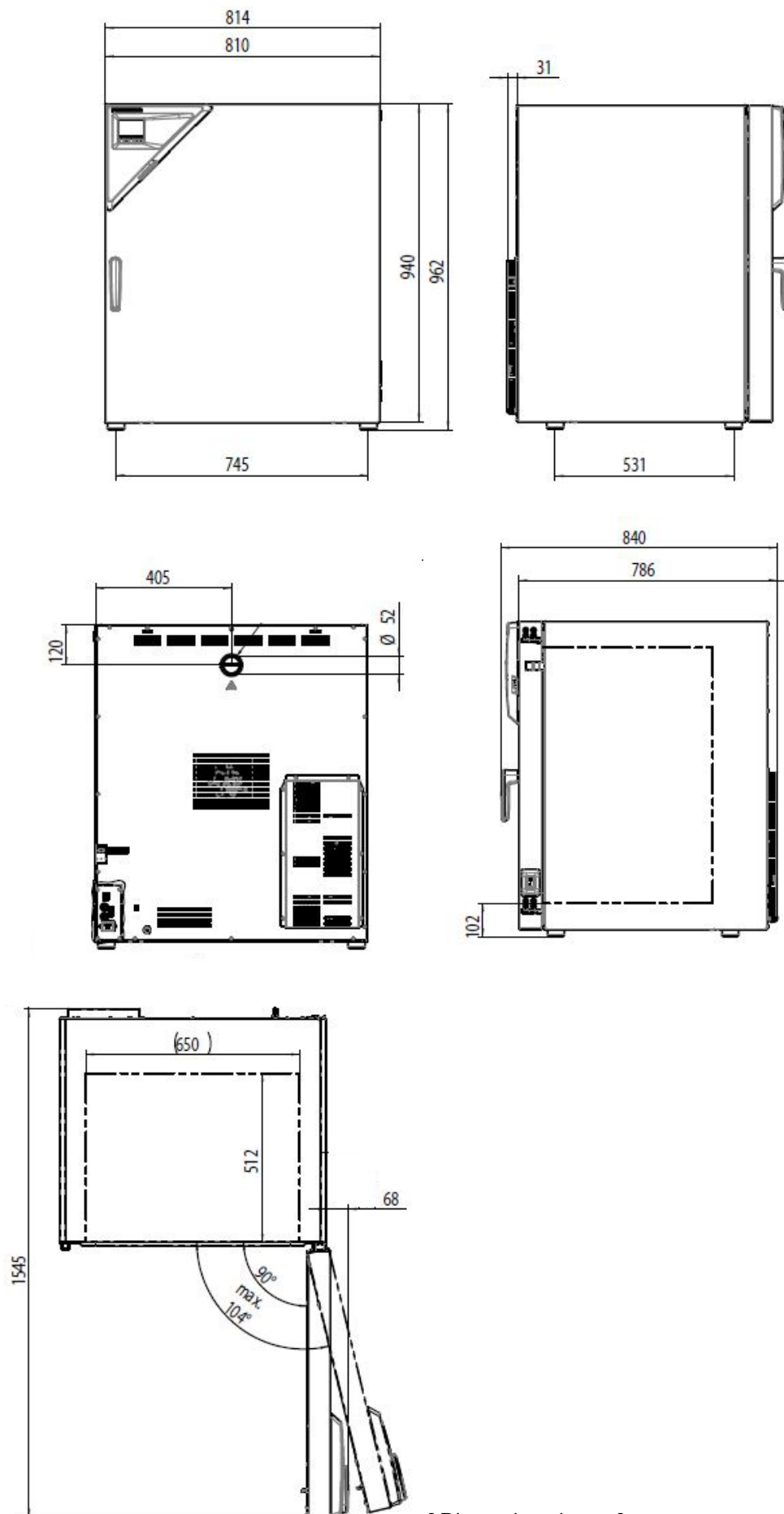

[ Dimensions in mm ]

### 23.10 Dimensions size 720

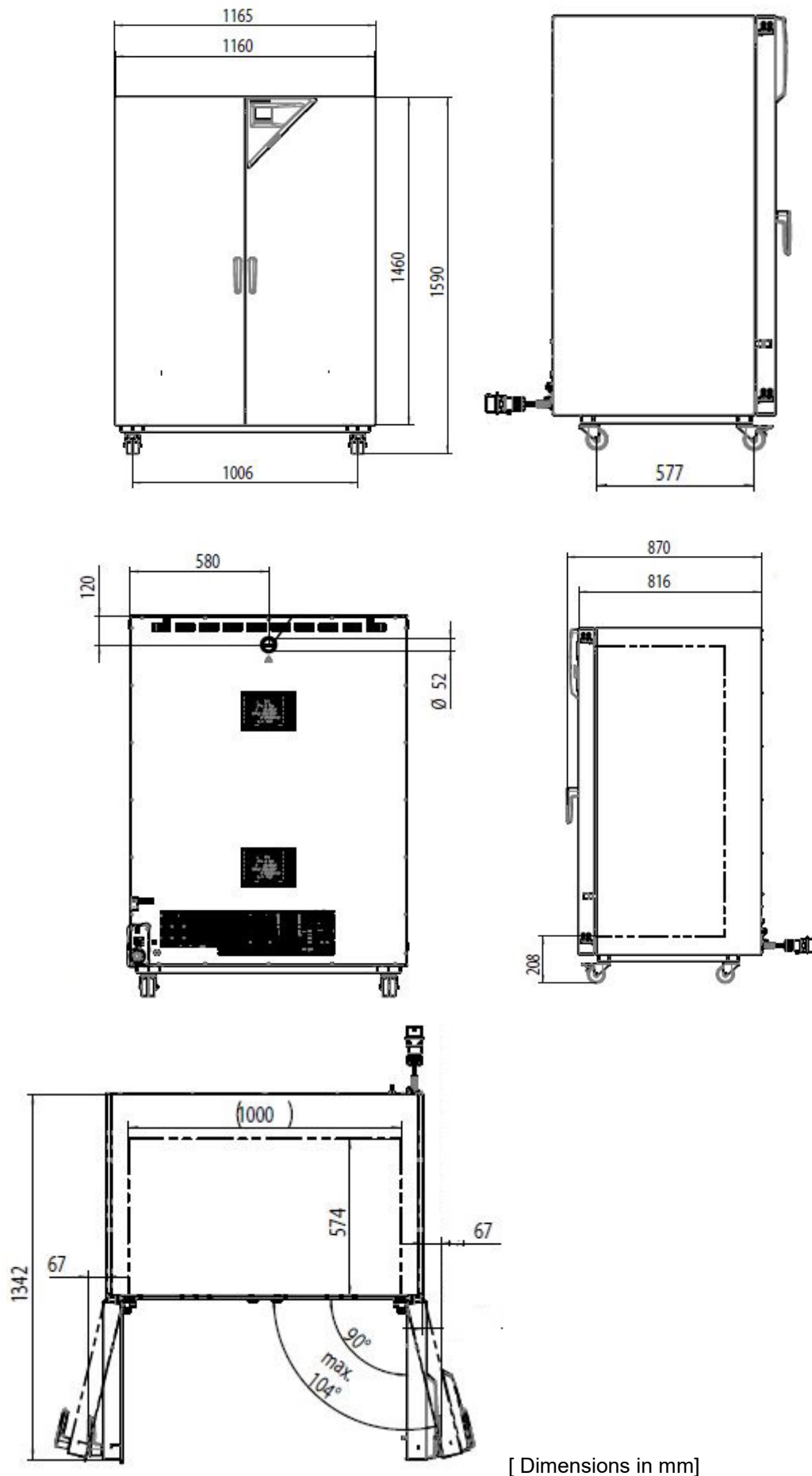

[ Dimensions in mm ]

## 24. Certificates and declarations of conformity

### 24.1 EU Declaration of Conformity

**CE** EU-Konformitätserklärung / EU Declaration of Conformity / Déclaration de conformité UE / Declaración de conformidad UE / Dichiarazione di conformità UE / Декларация соответствия EU

Hersteller / Manufacturer / Fabricant / Fabricante / Fabbicante / Производитель	BINDER GmbH
Anschrift / Address / Adresse / Dirección / Indirizzo / Адрес	Im Mittleren Ösch 5, 78532 Tuttlingen, Germany
Produkt / Product / Produit / Producto / Prodotto / Продукт	Trocken- und Wärmeschränke mit Umluft Drying and heating ovens with forced convection Etuves de chauffage et de séchage à convection forcée Estufas de secado y calentamiento con convección forzada Stufe per essiccazione e riscaldamento a convezione forzata Сушильные и сухожаровые шкафы с принудительной конвекцией
Typenbezeichnung / Type / Type / Tipo / Tipo / Тип	FP 56, FP 115, FP 260, FP 720 (E3.1)
Art. No. / Art. no. / Réf. / Art. N° / Art. n. / № apr.	9010-0363, 9010-0364, 9010-0365, 9010-0366, 9010-0367, 9010-0368, 9010-0369, 9010-0370

Die oben beschriebenen Maschinen sind konform mit folgenden EG/EU-Richtlinien (gemäß Veröffentlichung im Amtsblatt der europäischen Kommission):

The machines described above are in conformity with the following EC/EU Directives (as published in the Official Journal of the European Union):

Les machines décrites ci-dessus sont conformes aux directives CE/UE suivantes (selon leur publication dans le Journal officiel de l'Union européenne):

La máquina descrita arriba cumple con las siguientes directivas de la CE/UE (publicados en el Diario oficial de la Unión Europea):

Le macchine sopra descritte sono conforme alle seguenti direttive CE/UE (secondo la pubblicazione nella Gazzetta ufficiale della Commissione europea):

Машина, указанная выше, полностью соответствует следующим регламентам ЕС/ЕУ (опубликованным в Официальном журнале Европейского Содружества):

- **2006/42/EC**  
Maschinenrichtlinie 2006/42/EG / Machinery directive 2006/42/EC / Directive Machines 2006/42/EC / Directiva 2006/42/CE (Máquinas) / Direttiva macchine 2006/42/CE / Директива о машинах 2006/42/EC
- **2014/30/EU**  
EMV-Richtlinie 2014/30/EU / EMC Directive 2014/30/EU / Directive CEM 2014/30/UE / Directiva CEM 2014/30/UE / Direttiva EMC 2014/30/UE / Директива ЭМС 2014/30/EU
- **2011/65/EU, (EU) 2015/863**  
RoHS-Richtlinien 2011/65/EU und (EU) 2015/863 / RoHS Directives 2011/65/EU and (EU) 2015/863 / Directives RoHS 2011/65/UE et (UE) 2015/863 / Directivas RoHS 2011/65/UE y (UE) 2015/863 / Direttive RoHS 2011/65/UE et (UE) 2015/863 / Директивы RoHS 2011/65/EU и (EU) 2015/863

1 / 3



Die oben beschriebenen Maschinen entsprechen aufgrund ihrer Konzipierung und Bauart sowie in der von uns in Verkehr gebrachten Ausführung den einschlägigen grundlegenden Sicherheits- und Gesundheitsanforderungen der genannten EG/EU-Richtlinien.

The machines described above are conform to the mentioned EC/EU directives in regard to the relevant safety and health demands due to their conception and style of construction as well as to the version put onto market by us.

Les machines décrites ci-dessus correspondent aux demandes de sécurité et de santé des directives citées de la CE/UE due à leur conception et construction et dans la réalisation mise sur le marché par nous.

Las máquinas descritas arriba se corresponden con los requisitos básicos pertinentes de seguridad y salud de las citadas directivas de la CE/UE debido a su concepción y fabricación, así como a la realización llevada a cabo por nosotros.

Le macchine sopra descritte sono conforme ai requisiti essenziali di sanità e sicurezza pertinenti delle summenzionate direttive CE/UE in termini di progettazione, tipo di costruzione ed esecuzione messa da noi in circolazione.

Машины описано выше, соответствует указанным директивам ЕС/ЕУ в отношении требований соответствующей безопасности и здоровья по концепции и конструкции так же как и версия, применяемая нами на рынке.

Die oben beschriebenen Maschinen tragen entsprechend die Kennzeichnung CE.

The machines described above, corresponding to this, bear the CE-mark.

Les machines décrits ci-dessus, en correspondance, portent l'indication CE.

Las máquinas descritas arriba, en conformidad, llevan la indicación CE.

Le macchine sopra descritte sono contrassegnate dal marchio CE.

Машины описано выше, в соответствии с изложенным выше маркированы знаком CE.

Die oben beschriebenen Maschinen sind konform mit folgenden harmonisierten Normen:

The machines described above are in conformity with the following harmonized standards:

Les machines décrits ci-dessus sont conformes aux normes harmonisées suivantes :

Las máquinas descritas arriba cumplen con las siguientes normas:

Le macchine sopra descritte sono conforme alle seguenti normative armonizzate:

Машины описано выше, полностью соответствуют следующим стандартам:

2 / 3



Sicherheit / Safety / Sécurité / Seguridad / Sicurezza / Нормативы по безопасности
<ul style="list-style-type: none"><li>• <b>EN ISO 12100:2010 + Corr. 1:2011</b></li><li>• <b>EN ISO 13732-1:2008</b></li><li>• <b>EN 60204-1:2018</b></li></ul>
EMV / EMC / CEM / CEM / EMC / ЭМС
<ul style="list-style-type: none"><li>• <b>EN 61326-1:2013</b></li></ul>
RoHS
<ul style="list-style-type: none"><li>• <b>EN IEC 63000:2018</b></li></ul>

78532 Tuttlingen, 30.11.2022

BINDER GmbH



P. Wimmer

Vice President  
Vice President  
Vice président  
Vicepresidente  
Vicepresidente  
Вице-президент



J. Bollaender

Leiter F & E und Dokumentationsbevollmächtigter  
Director R & D and documentation representative  
Chef de service R&D et autorisé de documentation  
Responsable I & D y representante de documentación  
Direttore R & D e responsabile della documentazione  
Глава департамента R&D представитель документации

BINDER GmbH  
Im Mittleren Osch 5  
78502 Tuttlingen  
Deutschland

Tel: +49 (0) 74 62 / 20 05 - 0  
Fax: +49 (0) 74 62 / 20 05 - 100  
info@binder-world.com  
www.binder-world.com

Geschäftsführung:  
Dipl.-Ing. Peter M. Binder  
Amtsgericht Stuttgart, HRB 727150  
Sitz der Gesellschaft: Tuttlingen  
Ust.-ID.-Nr.: DE815021304

Kreissparkasse Tuttlingen  
IBAN: DE05 6435 0070 0000 0022 66  
SWIFT: SOLA DE 31TUT  
Deutsche Bank Tuttlingen  
IBAN: DE56 6537 0075 0213 8709 00  
SWIFT: DEUT DE 33653

## 24.2 UKCA Declaration of Conformity



	<h3>UKCA Declaration of Conformity</h3>
---	---

Name and address of manufacturer	BINDER GmbH Im Mittleren Ösch 5, 78532 Tuttlingen, Germany
Name and address of UK Authorised Representative	Comply Express Ltd Unit C2, Coalport House, Stafford Park 1, Telford TF3 3BD
Object of the Declaration	Drying and heating ovens with forced convection
Type Designation	FP 56, FP 115, FP 260, FP 720 (E3.1)
BINDER Art. No.	9010-0363, 9010-0364, 9010-0365, 9010-0366, 9010-0367, 9010-0368, 9010-0369, 9010-0370

The Objects of the Declaration described above are in conformity with the relevant UK Regulations and UK Guidelines:

- **Supply of Machinery (Safety) Regulations 2008**  
Statutory Instruments 2008 No. 1597 – Health and safety
- **Electromagnetic Compatibility Regulations 2016**  
Statutory Instruments 2016 No. 1091 – Electromagnetic Compatibility
- **The Restriction of the Use of Certain Hazardous Substances in Electrical and Electronic Equipment Regulations 2012**  
Statutory Instruments 2012 No. 3032 – Environmental Protection

References of standards and/or technical specifications applied for this Declaration of Conformity, or parts thereof:

<b>S.I. 2008 No. 1597:</b>	EN ISO 12100:2010 EN ISO 13732-1:2008 EN 60204-1:2018
<b>S.I. 2016 No. 1091:</b>	EN 61326-1:2013
<b>S.I. 2012 No. 3032:</b>	EN IEC 63000:2018

This Declaration is issued under the sole responsibility of the manufacturer.

Tuttlingen	30.11.2022			
Place	Date	P. Wimmer Vice President	J. Bollaender Director R & D	BINDER GmbH

BINDER GmbH  
Im Mittleren Ösch 5  
78502 Tuttlingen  
Deutschland

Tel: +49 (0) 74 62 / 20 05 - 0  
Fax: +49 (0) 74 62 / 20 05 - 100  
info@binder-world.com  
www.binder-world.com

Geschäftsführung:  
Dipl.-Ing. Peter M. Binder  
Amtsgericht Stuttgart, HRB 727150  
Sitz der Gesellschaft: Tuttlingen  
Ust.-ID.-Nr.: DE815021304

Kreissparkasse Tuttlingen  
IBAN: DE05 6435 0070 0000 0022 66  
SWIFT: SOLA DE 31TUT  
Deutsche Bank Tuttlingen  
IBAN: DE56 6537 0075 0213 8709 00  
SWIFT: DEUT DE 33653

## 24.3 Certificate for the GS mark of conformity of the "Deutsche Gesetzliche Unfallversicherung e.V." (German Social Accident Insurance) DGUV

Zertifikat  
Nr. **NV 23037**  
vom 17.02.2023



### GS-Zertifikat

Name und Anschrift des Zertifikatsinhabers: (Auftraggeber)	<b>Binder GmbH</b> Im Mittleren Ösch 5 78532 Tuttlingen
Produktbezeichnung:	<b>Trocken- und Wärmeschränke mit Umluft</b>
Typ:	FP 56, FP 115, FP 260, FP 720
Prüfgrundlage:	GS-NV 2:2019/08 Prüfgrundsätze für Nahrungsmittelmaschinen
Zugehöriger Prüfbericht:	Prüfbericht zum Zertifikat NV 23037
Weitere Angaben:	Das Zertifikat bezieht sich auf die im zugehörigen Prüfbericht beschriebene Ausführung des Produkts.

Das geprüfte Baumuster stimmt mit den in § 21 Absatz 1 des Produktsicherheitsgesetzes genannten Anforderungen überein. Der Zertifikatsinhaber ist berechtigt, das umseitig abgebildete GS-Zeichen an den mit dem geprüften Baumuster übereinstimmenden Produkten anzubringen. Der Zertifikatsinhaber hat dabei die umseitig aufgeführten Bedingungen zu beachten.

Dieses Zertifikat einschließlich der Berechtigung zur Anbringung des GS-Zeichens ist gültig bis einschließlich:

**16.02.2028**

Weiteres über die Gültigkeit, eine Gültigkeitsverlängerung und andere Bedingungen regelt die Prüf- und Zertifizierungsordnung.



PZB04\_D  
01.18

Deutsche Gesetzliche Unfallversicherung (DGUV) e.V.  
Spitzenverband der gewerblichen Berufsgenossenschaften  
und der Unfallversicherungsträger der öffentlichen Hand  
Vereinsregister-Nr. VR 751 B, Amtsgericht Charlottenburg

DGUV Test Prüf- und Zertifizierungsstelle Nahrungsmittel und Verpackung  
Fachbereich Nahrungsmittel  
Dynamostraße 7-11 • 68165 Mannheim • Deutschland  
Telefon: +49 (0) 6 21 44 56-34 30 • Fax: +49 (0) 800 1977 553 16625

Rückseite GS-Zertifikat: NV 23037

### GS-Zeichen



Normalausführung



Bei einer Höhe von 20 mm oder weniger  
auch zulässige Ausführung

1. Der Zertifikatsinhaber hat die Voraussetzungen einzuhalten, die bei der Herstellung des umseitig genannten Produktes zu beachten sind, um die Übereinstimmung mit dem geprüften Baumuster zu gewährleisten.
2. Die Prüf- und Zertifizierungsstelle des Fachbereichs Nahrungsmittel führt in regelmäßigen Abständen Kontrollmaßnahmen zur Überwachung der Herstellung und rechtmäßigen Verwendung des GS-Zeichens durch.
3. Die für die Herstellung verantwortliche Person hat sich zur Einhaltung der Voraussetzungen nach Nummer 1 und Duldung der Kontrollmaßnahmen verpflichtet.
4. Die Prüf- und Zertifizierungsstelle entzieht dem Zertifikatsinhaber die Zuerkennung des GS-Zeichens, wenn sich die Anforderungen nach § 21 Absatz 1 Produktsicherheitsgesetz geändert haben oder die Voraussetzungen nach Nummer 1 nicht eingehalten werden.
5. Das GS-Zeichen darf nur verwendet und mit ihm darf nur geworben werden, wenn die Voraussetzungen nach § 22 Produktsicherheitsgesetz erfüllt sind.

## 25. Contamination clearance certificate

### 25.1 For chambers located outside the USA and Canada

#### Declaration with regard to safety and health

Erklärung zur Sicherheit und gesundheitlichen Unbedenklichkeit

The German Ordinance on Hazardous Substances (GefStofV), and the regulations regarding safety at the workplace, require that this form be filled out for all products that are returned to us, so that the safety and health of our employees can be warranted.

Die Sicherheit und Gesundheit unserer Mitarbeiter, die Gefahrstoffverordnung GefStofV und die Vorschriften zur Sicherheit am Arbeitsplatz machen es erforderlich, dass dieses Formblatt für alle Produkte, die an uns zurückgeschickt wird.



In the absence of a completely filled out form, a repair is not possible.  
Ohne Vorliegen des vollständig ausgefüllten Formblattes ist eine Reparatur nicht möglich.

- A completely filled out form should be transmitted by Fax (+49 (0) 7462 2005 93555) or by letter in advance to us, so that this information is available before the equipment/component part arrives. A second copy of this form should accompany the equipment/component part. Eventually the carrier should be informed.

Eine vollständig ausgefüllte Kopie dieses Formblattes soll per Telefax (Nr. +49 (0) 7462 2005 93555) oder Brief vorab an uns gesandt werden, so dass die Information vorliegt, bevor das Gerät/Bauteil eintrifft. Eine weitere Kopie soll dem Gerät/Bauteil beigelegt sein. Ggf. ist auch die Spedition zu informieren.

- Incomplete information or non-conformity with this procedure will inevitably lead to substantial delays in processing. We hope you will have understanding for this measure, which lies outside of our area of influence, and that you will help us to speed up this procedure.

Unvollständige Angaben oder Nichteinhalten dieses Ablaufs führen zwangsläufig zu beträchtlichen Verzögerungen in der Abwicklung. Bitte haben Sie Verständnis für Maßnahmen, die außerhalb unserer Einflussmöglichkeiten liegen und helfen Sie mit, den Ablauf beschleunigen.

- **Please fill out this form completely.**

**Bitte unbedingt vollständig ausfüllen!**

<b>1.</b>	<b>Chamber/ component part / type: / Gerät / Bauteil / Typ:</b>
<b>2.</b>	<b>Serial No./ Serien-Nr.:</b>
<b>3.</b>	<b>Details about utilized substances / biological substances / Einzelheiten über die eingesetzten Substanzen/biologische Materialien:</b>
<b>3.1</b>	<b>Designations / Bezeichnungen:</b>
a)	_____
b)	_____
c)	_____
<b>3.2</b>	<b>Safety measures required for handling these substances / Vorsichtsmaßnahmen beim Umgang mit diesen Stoffen:</b>
a)	_____
b)	_____
c)	_____

<b>3.3</b>	<b>Measures to be taken in case of skin contact or release into the atmosphere / Maßnahmen bei Personenkontakt oder Freisetzung:</b>
	a) _____
	b) _____
	c) _____
	d) _____
<b>3.4</b>	<b>Other important information that must be taken into account / Weitere zu beachtende und wichtige Informationen:</b>
	a) _____
	b) _____
	c) _____
<b>4.</b>	<b>Declaration on the risk of these substances (please checkmark the applicable items) / Erklärung zur Gefährlichkeit der Stoffe (bitte Zutreffendes ankreuzen) :</b>
	<input type="checkbox"/> <b>4.1 For non toxic, non radioactive, biologically harmless materials / für nicht giftige, nicht radioaktive, biologisch ungefährliche Stoffe:</b> <b>We herewith guarantee that the above-mentioned chamber / component part... / Wir versichern, dass o.g. Gerät/Bauteil...</b>
	<input type="checkbox"/> Has not been exposed to or contains any toxic or otherwise hazardous substances / weder giftige noch sonstige gefährliche Stoffe enthält oder solche anhaften. <input type="checkbox"/> That eventually generated reaction products are non-toxic and also do not represent a hazard / auch evtl. entstandene Reaktionsprodukte weder giftig sind noch sonst eine Gefährdung darstellen. <input type="checkbox"/> Eventual residues of hazardous substances have been removed / evtl. Rückstände von Gefahrstoffen entfernt wurden.
	<input type="checkbox"/> <b>4.2 For toxic, radioactive, biologically harmful or hazardous substances, or any other hazardous materials / für giftige, radioaktive, biologisch bedenkliche bzw. gefährliche Stoffe oder anderweitig gefährliche Stoffe.</b> <b>We herewith guarantee that ... / Wir versichern, dass ...</b>
	<input type="checkbox"/> The hazardous substances, which have come into contact with the above-mentioned equipment/component part, have been completely listed under item 3.1 and that all information in this regard is complete / die gefährlichen Stoffe, die mit dem o.g. Gerät/Bauteil in Kontakt kamen, in 3.1 aufgelistet sind und alle Angaben vollständig sind. <input type="checkbox"/> That the chamber /component part has not been in contact with radioactivity / das Gerät/Bauteil nicht mit Radioaktivität in Berührung kam
<b>5.</b>	<b>Kind of transport / transporter / Transportweg/Spediteur:</b>
	Transport by (means and name of transport company, etc.) Versendung durch (Name Spediteur o.ä.)
	_____
	Date of dispatch to BINDER GmbH / Tag der Absendung an BINDER GmbH:
	_____

**We herewith declare that the following measures have been taken / Wir erklären, dass folgende Maßnahmen getroffen wurden:**

- Hazardous substances were removed from the chamber / component part, so that no hazard exists for corresponding persons in the handling or repair of these items / das Gerät/Bauteil wurde von Gefahrstoffen befreit, so dass bei Handhabung/Reparaturen für die betreffenden Person keinerlei Gefährdung besteht
- The chamber was securely packaged and properly identified / das Gerät wurde sicher verpackt und vollständig gekennzeichnet.
- Information about the hazardousness of the shipment (if required) has been provided to the transporter / der Spediteur wurde (falls vorgeschrieben) über die Gefährlichkeit der Sendung informiert.

We herewith commit ourselves and guarantee that we will indemnify BINDER GmbH for all damages that are a consequence of incomplete or incorrect information provided by us, and that we will exempt BINDER GmbH from eventual damage claims by third parties. / Wir versichern, dass wir gegenüber BINDER für jeden Schaden, der durch unvollständige und unrichtige Angaben entsteht, haften und BINDER gegen eventuell entstehende Schadensansprüche Dritter freistellen.

We are aware that, in accordance with Article 823 of the German Civil Code (BGB), we are directly liable with regard to third parties, in this instance especially the employees of BINDER GmbH, who have been entrusted with the handling / repair of the chamber / component. / Es ist uns bekannt, dass wir gegenüber Dritten – hier insbesondere mit der Handhabung/Reparatur des Geräts/des Bauteils betraute Mitarbeiter der Firma BINDER - gemäß §823 BGB direkt haften

Name: \_\_\_\_\_

Position: \_\_\_\_\_

Date / Datum: \_\_\_\_\_

Signature / Unterschrift: \_\_\_\_\_

Company stamp / Firmenstempel:



Equipment that is returned to the factory for repair must be accompanied by a completely filled out contamination clearance certificate. For service and maintenance works on site, such a contamination clearance certificate must be submitted to the service technician before the start of the works. No repair or maintenance of the equipment is possible, without a properly filled out contamination clearance certificate.



## 25.2 For chambers located in the USA and Canada

### Product Return Authorization Request

Please complete this form and the Customer Decontamination Declaration (next 2 pages) and attach the required pictures. E-mail to: IDL\_SalesOrderProcessing\_USA@binder-world.com

After we have received and reviewed the complete information we will decide on the issue of a RMA number. Please be aware that size specifications, voltage specifications as well as performance specifications are available on the internet at [www.binder-world.us](http://www.binder-world.us) at any time.

Take notice of shipping laws and regulations.

	Please fill:	
Reason for return request	<input type="radio"/> Duplicate order	
	<input type="radio"/> Duplicate shipment	
	<input type="radio"/> Demo	<i>Page one completed by sales</i>
	<input type="radio"/> Power Plug / Voltage	115V / 230 V / 208 V / 240V
	<input type="radio"/> Size does not fit space	
	<input type="radio"/> Transport Damage	Shock watch tripped? ( <i>pictures</i> )
	<input type="radio"/> Other (specify below)	
	_____	
Is there a replacement PO?	<input type="radio"/> Yes <input type="radio"/> No	
	<i>If yes -&gt; PO #</i>	
	<i>If yes -&gt; Date PO placed</i>	
Purchase order number		
BINDER model number		
BINDER serial number		
Date chamber was received		
Was the chamber unboxed?	<input type="radio"/> Yes <input type="radio"/> No	
Was the chamber plugged in?	<input type="radio"/> Yes <input type="radio"/> No	
Was the chamber in operation?	<input type="radio"/> Yes <input type="radio"/> No	
<i>Pictures of chamber attached?</i>	<input type="radio"/> Yes <input type="radio"/> No	Pictures have to be attached!
<i>Pictures of Packaging attached?</i>	<input type="radio"/> Yes <input type="radio"/> No	

	Customer Contact Information	Distributor Contact Information
Name		
Company		
Address		
Phone		
E-mail		



## Customer (End User) Decontamination Declaration

### Health and Hazard Safety declaration

To protect the health of our employees and the safety at the workplace, we require that this form is completed by the user for all products and parts that are returned to us. (Distributors or Service Organizations cannot sign this form)



NO RMA number will be issued without a completed form. Products or parts returned to our NY warehouse without a RMA number will be refused at the dock.

A second copy of the completed form must be attached to the outside of the shipping box.

<b>1.</b>	<b>Chamber/ component part / type:</b>
<b>2.</b>	<b>Serial No.</b>
<b>3.</b>	<b>List any exposure to hazardous liquids, gasses or substances and radioactive material</b>
<b>3.1</b>	<b>List with MSDS sheets attached where available or needed (if there is not enough space available below, please attach a page):</b>
a)	_____
b)	_____
c)	_____
<b>3.2</b>	<b>Safety measures required for handling the list under 3.1</b>
a)	_____
b)	_____
c)	_____
<b>3.3</b>	<b>Measures to be taken in case of skin contact or release into the atmosphere:</b>
a)	_____
b)	_____
c)	_____
d)	_____
<b>3.4</b>	<b>Other important information that must be considered:</b>
a)	_____
b)	_____
c)	_____

**4. Declaration of Decontamination**

**For toxic, radioactive, biologically and chemically harmful or hazardous substances, or any other hazardous materials.**

**We hereby guarantee that**

- 4.1 Any hazardous substances, which have come into contact with the above-mentioned equipment / component part, have been completely listed under item 3.1 and that all information in this regard is complete.
- 4.2 That the chamber /component part has not been in contact with radioactivity
- 4.3 Any Hazardous substances were removed from the chamber / component part, so that no hazard exists for a persons in the shipping, handling or repair of these returned chamber
- 4.4 The chamber was securely packaged in the original undamaged packaging and properly identified on the outside of the packaging material with the chamber designation, the RMA number and a copy of this declaration.
- 4.5 Shipping laws and regulations have not been violated.

**I hereby commit and guarantee that we will indemnify BINDER Inc. for all damages that are a consequence of incomplete or incorrect information provided by us, and that we will indemnify and hold harmless BINDER Inc. from eventual damage claims by third parties.**

Name: \_\_\_\_\_

Position: \_\_\_\_\_

Company: \_\_\_\_\_

Address: \_\_\_\_\_

Phone #: \_\_\_\_\_

Email: \_\_\_\_\_

Date: \_\_\_\_\_

Signature: \_\_\_\_\_



Equipment returned to the NY warehouse for repair must be accompanied by a completed customer decontamination declaration. For service and maintenance works on site, such a customer decontamination declaration must be submitted to the service technician before the start of work. No repair or maintenance of the equipment is possible without a completed form.

